



MClimate Wireless Thermostat LoRaWAN®

[User manual](#)

Scan the QR Code to access MClimate Wireless Thermostat LoRaWAN® extended documentation



mclimate.eu/lorawan-resources

Bulgarian

За да разберете как се инсталира MClimate Wireless Thermostat LoRaWAN®, сканирайте QR кода или посетете линка до него.

Czech

Chcete-li zjistit, jak nainstalovat MClimate Wireless Thermostat LoRaWAN®, prohlédněte si kód QR nebo navštivte odkaz vedle něj.

Finnish

Tutustu MClimate Wireless Thermostat LoRaWAN®-laitteen asentamiseen, skanna QR-koodi tai vierailla sen viereissä olevassa linkissä.

Danish

For at finde ud af, hvordan du installerer MClimate Wireless Thermostat LoRaWAN®, scan QR-koden eller besøg linket ud for det.

Italian

Per installare MClimate Wireless Thermostat LoRaWAN® scannerizzare il codice QR oppure aprire il link al suo lato.

German

Um herauszufinden, wie man MClimate Wireless Thermostat LoRaWAN® installiert, scannen Sie den QR-Code oder besuchen Sie den Link daneben.

Latvian

Lai uzzinātu, kā instalēt MClimate Wireless Thermostat LoRaWAN®, skenēt QR kodu vai apmeklējiet saiti blakus tai.

Spanish

Para saber cómo instalar MClimate Wireless Thermostat LoRaWAN®, escanee el código QR o visite el enlace al lado.

Dutch

Om te weten te komen hoe u MClimate Wireless Thermostat LoRaWAN® installeert, scan de QR-code of bezoek de link ernaast.

Hungarian

A MClimate Wireless Thermostat LoRaWAN® telepítésének kiderítéséhez keresse meg a QR-kódot, vagy keresse fel a mellette található linket.

Irish

Chun a fháil amach conas a shuiteáil MClimate Wireless Thermostat LoRaWAN®, scanadh an cód QR nó tabhair cuairt ar an nasc in aice leis é.

French

Pour savoir comment installer MClimate Wireless Thermostat LoRaWAN®, scannez le code QR ou visitez le lien à côté de celui-ci.

Estonian

Et teada saada, kuidas installida MClimate Wireless Thermostat LoRaWAN®, QR-koodi või külastada linki kõrval.

Swedish

För att ta reda på hur du installerar MClimate Wireless Thermostat LoRaWAN®, skanna QR-koden eller besök länken bredvid den.

Portuguese

Para saber como instalar MClimate Wireless Thermostat LoRaWAN®, digitalize o código QR ou visite o link ao lado dele.

Maltese

Biex issir taf kif jinstallaw MClimate Wireless Thermostat LoRaWAN®, skennjati l-kodiċi QR jew żur il-link li jmissi lula.

Romanian

Pentru a afla cum să instalați MClimate Wireless Thermostat LoRaWAN®, scanați codul QR sau accesați link-ul de lângă acesta.

Slovak

Ak chcete zistiť, ako nainštalovať MClimate Wireless Thermostat LoRaWAN®, skenujte kód QR alebo navštívte odkaz vedľa neĳ.

Russian

Чтобы узнать, как установить MClimate Wireless Thermostat LoRaWAN®, отсканируйте QR-код или перейдите по ссылке, расположенной рядом с ним.

Lithuanian

Norėdami sužinoti, kaip įdiegti MClimate Wireless Thermostat LoRaWAN®, nuskaitykite QR kodą arba apsilankykite nuorodą šalia jo.

Polish

Aby dowiedzieć się, jak zainstalować MClimate Wireless Thermostat LoRaWAN®, zeskanuj kod QR lub odwiedź link obok niego.

Greek

Για να μάθετε πως να εγκαταστήσετε τον MClimate Wireless Thermostat LoRaWAN®, σκανάρτε τον QR κωδικό ή επισκεφτείτε τον σύνδεσμο δίπλα του.

Need some help?



For more product information and issues related to it, visit: mclimate.eu/lorawan-resources

or write us to: lorawan-support@mclimate.eu



00359 800 3 1010
Monday-Friday 09:00 - 18:00



Sofia, Bulgaria
Aleksandar Malinov Boulevard 31, Campus X, Building 2,
floor 1, office 1-2

Table of content

01	What is in the box?	2
02	Technical details, Safety instructions, Legal Notices & Compatibility	3
03	Device Parts, Mechanical dimensions	4
04	Placement guidelines	5
05	Display's content	6
06	Buttons	7
07	Behavior	8
08	Installation	9
09	Commissioning	10

What's inside the box?

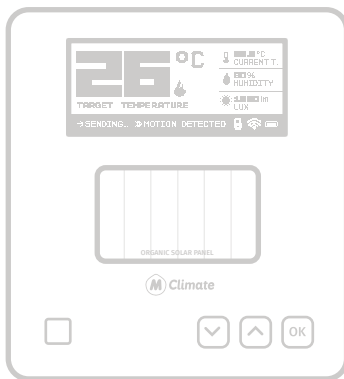

MClimate Wireless Thermostat LoRaWAN®

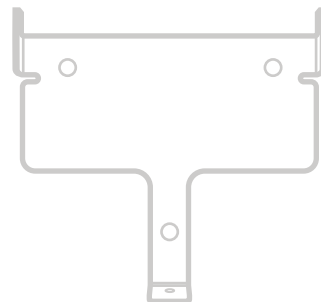

Wall mounting plate



Secure bolt

Technical specifications

Description: MClimate Wireless Thermostat is a stand-alone thermostat entirely by solar energy using an organic solar panel. The device features a 2.9" e-ink screen, sensor for movement (PIR), temperature and humidity sensor, LUX sensor and 3 buttons. The user can change the target temperature and see current indoor conditions. The device sends an uplink after any event as well as periodically. The data from the Wireless Thermostat can be used in any LoRaWAN-compatible system, incl. Building Management Systems to control different appliances in the building.

Created by MClimate™

SKU: MC-LW-WT-01

Dimensions: 105 x 115 x 23mm

Weight: 170gr

Materials: ABS, Stainless steel, tempered glass

Frequency range: 863-870MHz

Power supply: Solar-powered Lithium-ion capacitor (LIC) AND/OR 4xAA 1.5VDC batteries AND/OR USB-C

Sensors: Temperature, humidity, PIR, LUX, CO2 (optional)

Working temperature: 0°C to +50°C

Environmental conditions, in which the device is intended to operate:

- Indoor use only;
- for altitude up to 2000m;
- for an ambient temperature: 0°C to +50°C;
- for maximum relative humidity of 80% for temperature up to 31°C, decreasing linearly to 25% relative humidity at temperature 50°C;
- for an environment with a degree of contamination 2 (PD2).

Storage and transportation conditions:

- for an ambient temperature: -40°C to +85°C;
- for relative humidity 5% to 90% without condensation

Manufacturer

MClimate Jsc
1729 Sofia 31, Alexander Malinov Blvd
Building 2, Floor 2

Compliance with the WEEE Directive

The appliance marked with this symbol should not be disposed of with other household waste. It must be handed over to the relevant collection point for the recycling of electrical and electronic equipment.

⚠ Safety Instructions

Please read the safety instructions before installing the device! Failure to follow the recommended instructions in this manual may be dangerous or in violation of the law. The manufacturer MClimate Jsc., is not responsible for any loss or damage caused by failure to follow the instructions in the operating manual.

Legal Notices

All information, including but not limited to, features, functionality, and / or other product specifications are subject to change without notice. MClimate retains all rights to review or update its products, software or documentation without being required to notify any natural or legal person.

The MClimate and MClimate logo are trademarks of MClimate Jsc. All other brands and product names mentioned herein are trademarks of their respective owners.

EU Declaration of Conformity

This device complies with the essential requirements and other applicable provisions of the following EU directives:

2014/53/EC

EN 50491-3:2009

EEU 300 220-1 V3.1.1:2017

EEU 300 220-2 V3.1.1:2017

EN 60950-1:2006+A11:2009 +A1:2010+A12:2011+

A2:2013 + AC:2015

EN 301 489-1 V2.1.1:2017

Compatibility

In order to operate MClimate Wireless Thermostat LoRaWAN®, you will need: LoRaWAN® network



Device parts

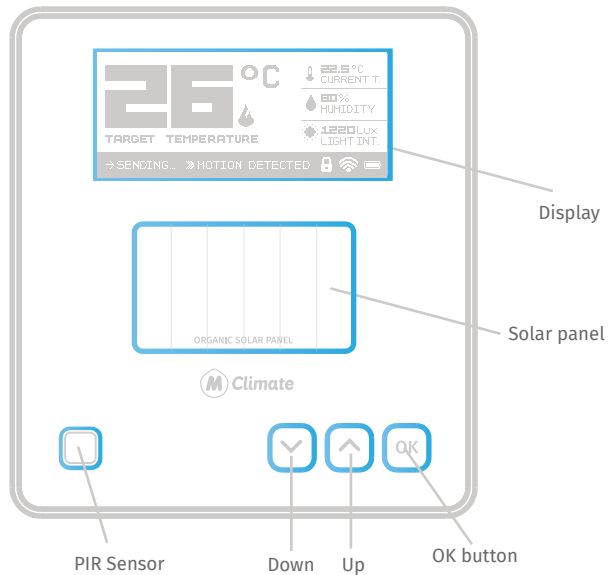

Assembled MClimate Wireless Thermostat LoRaWAN®, top view

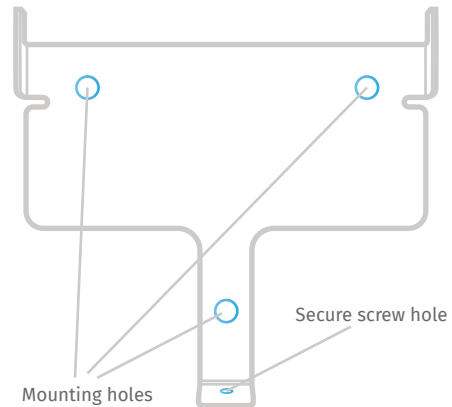

Wall mounting plate, top view

Placement guidelines



Do not place the device in direct sunlight, as this will result in gradual worsening of the performance of the solar panel. A few hours a day in direct sunlight wouldn't be an issue.

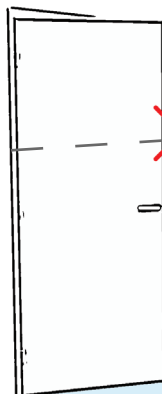
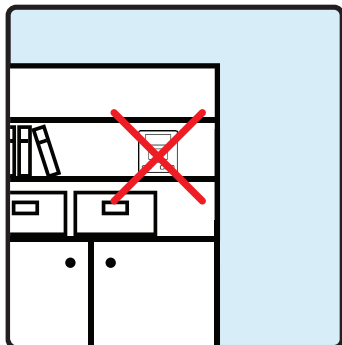
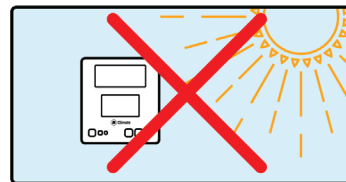
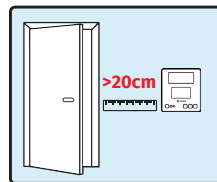

150cm

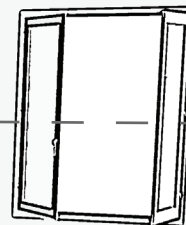

Display's content

The image below has all visible elements of the display activated.



The 2.9" e-ink display supports fast partial refresh. Full refresh is performed every 12 hours (period can be adjusted via a downlink) to avoid the e-ink phenomena "image sticking" and steer clear of permanent damage to the display.

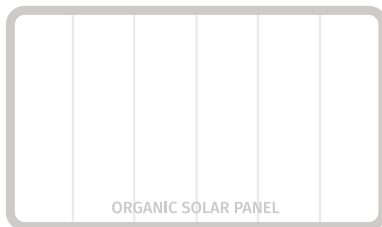
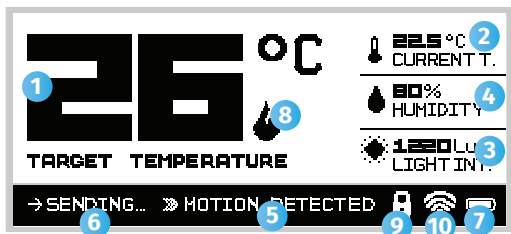

#	Description
1	Target temperature
2	Sensor temperature
3	LUX reading
4	Humidity reading
5	Shown when movement is detected by the PIR
6	Shows when the sensor is transmitting an uplink
7	Power source indicator - solar, battery, USB
8	Fire icon - showing automatically by default when target temperature is higher than sensor temperature. Automatic showing of the icon can be disabled and status of the Fire icon can be controlled through downlinks.
9	Child lock icon - indicates that the thermostat is locked.
10	Spreading factor indicator SF7 & SF8 SF10, SF11, SF12 SF9

Buttons

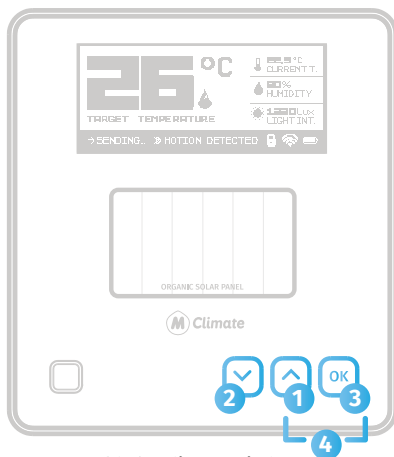

Assembled MClimate Wireless Thermostat LoRaWAN®, top view

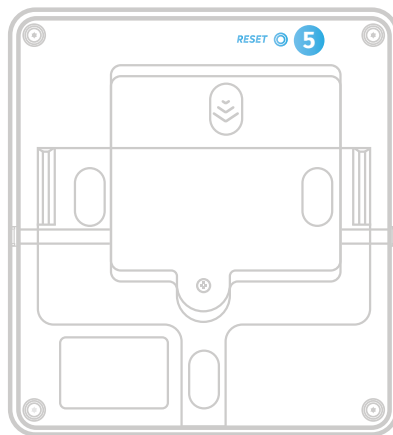

Assembled MClimate Wireless Thermostat LoRaWAN®, bottom view

#	Button	Function
1	Up arrow	Increase the target temperature
2	Down arrow	Decrease the target temperature
3	OK	Reserved for future use
4	OK + Up for 4 seconds	Child lock
5	Reset	Resets the device, triggers another Join-Request on SF9. Performs full refresh of the screen. Performing a Reset IS NOT equal to factory reset. All configured parameters are preserved.

Behavior

Start-up behavior

The device starts when you expose it to light or press the Reset button on the back.

At startup, the device measures the voltage of the supercapacitor, which is storing the energy harvested by the solar panel. If the voltage is within the working range of the device, the device will initiate a LoRaWAN Join-Request procedure on SF9.

Collecting and storing energy

The energy harvested by the Organic Solar Panel is stored in a supercapacitor. If the supercapacitor is discharged for some reason, the device will wake-up again when it has harvested enough power so that the voltage of the supercapacitor is within the working voltage of the device.

Example reasons for preliminary discharge can be:

- Device installed, but not provisioned in a LoRaWAN Network Server.
- Gateway not present.
- The device has been stored in packaging for too long.

If you want to get started quickly, you can use the USB-C port to charge the capacitor from a 5VDC power supply, which takes approx 20 minutes.

The time it takes to recharge will depend on the lighting conditions, but in a brightly lit office with 1000 lux, it should take around 12 hours.

Using multiple energy

The Wireless Thermostat has three options for power supply:

- Organic Solar Panel
- USB-C
- 2 or 4 AA Batteries (1.5VDC each)

You can use both solar and USB-C or AA batteries at the same time. If you use USB-C or AA batteries, the super capacitor will be charged and the solar harvesting will always be with highest priority.

Data transmissions

Once joined, the device will execute two types of transmissions:

- Periodic, as configured
- Immediate, when something changed - e.g. target temperature changed or movement detected in the room.

All transmissions are subject to complying with the duty-cycle limitations of LoRaWAN end-devices.

Installation

We recommend installing the device in an open environment (e.g. not in a recess) at 1.5m height. Do not install the device near big metal items as it will worsen the RF performance. Use double-sided tape to attach it to the surface or screws and dowels to attach the anti-theft bracket in a more permanent manner.

Once you've attached the anti-theft bracket, place the device on top so the two mounting points on the bracket correspond with the device's plastic. Slide down and secure with the security bolt on the bottom.

If you decide to insert AA 1.5VDC batteries into the device, you can use either 2 or 4 batteries. We recommend using Energizer Ultimate Lithium AA L91. You can insert 4 batteries as shown on the device's plastic or 2 batteries as shown in the picture below.

When using 2 or 4 AA batteries, please make sure that all batteries are new. If one of the batteries has lower voltage, it's not possible to use the full energy capacitance. That challenge is valid for all devices operated by multiple battery cells, e.g. your TV remote.

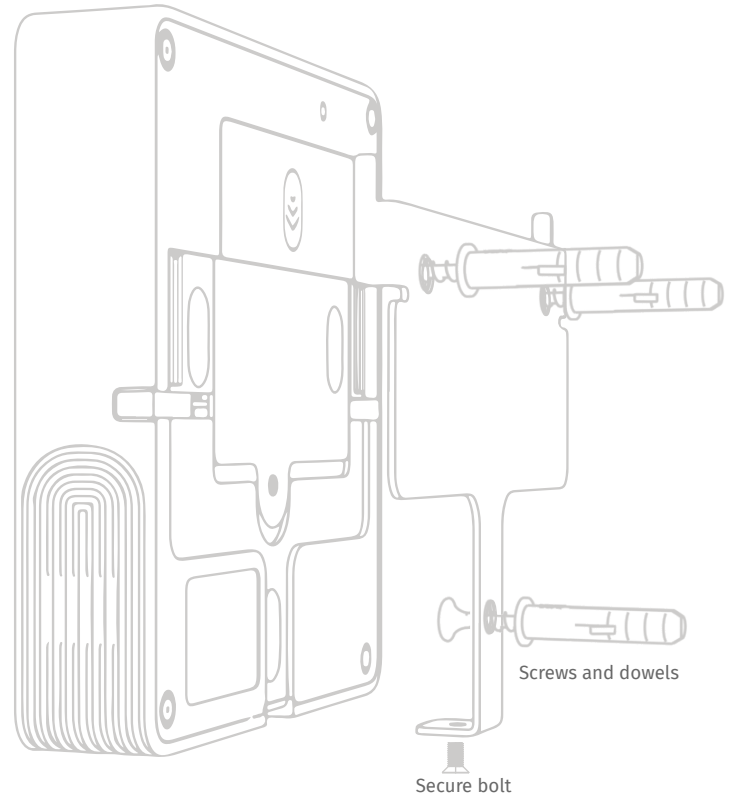

Commissioning



Before you install the device, we highly recommend that you first commission it on your LNS. Once the device is restarted or exposed to light, it'll initiate a LoRaWAN Join Procedure using SF9. Please, make sure you enable ADR in your LNS and/or mark the device as static. The lower the spreading factor, the better the performance of the energy storage will be.

- 1 Open your LoRaWAN® Network provider access panel and add the device using the supplied Serial Number, DevEUI, AppEUI (JoinEUI) and AppKey.
- 2 Continue the Installation with the instructions of your LoRaWAN® Network provider.

Device ID: 9X7 2745

DevEUI: 70B3D25D030000E1

AppEUI: 70B3D25D03000000

AppKey: A0658DFAE7213 5AFC048B3C71

Register



The data is example. Do not use.

MClimate_LoRaWAN_51177

Serial Number	DevEui	AppEui	AppKey
GW0000000000000000	70B3D25D030000E1	70B3D25D03000000	5fc31044a028948a4d31105a077620



You can get DevEUI, AppEUI (JoinEUI) & AppKey information from the LoRaWAN® credentials .csv file we sent you with the fulfillment confirmation.



www.mclimate.eu

Designed & Manufactured by MClimate in Europe.

last update: 23.02.2023