

Operating manual

Publish Date: 2023-01-30

v1.0



 **LoRaWAN** Wireless sensor

Operating manual

ERS2 series



ElektronikSystem i Umeå AB Tvistevägen 48C, 90736 Umeå, Sweden

E-mail: support@elsys.se | Web: www.elsys.se

Specifications in this document are subject to change without notice.

©ElektronikSystem i Umeå AB 2022

Important safety information



Read this manual before attempting to install the device!

Failure to observe recommendations included in this manual may be dangerous or cause a violation of the law. The manufacturer, ElektronikSystem i Umeå AB will not be held responsible for any loss or damage resulting from not following the instructions of this operating manual.

- The device must not be dismantled or modified in any way.
- The device is only intended for indoor use. Do not expose it to moisture.
- The device is not intended to be used as a reference sensor, and ElektronikSystem i Umeå AB will not be held liable for any damage which may result from inaccurate readings.
- The battery should be removed from the device if it is not to be used for an extended period. Otherwise, the battery might leak and damage the device. Never leave a discharged battery in the battery compartment.
- The device must never be subjected to shocks or impacts.
- To clean the device, wipe with a soft moistened cloth. Use another soft, dry cloth to wipe dry. Do not use any detergent or alcohol to clean the device.



Disposal note in accordance with Waste from Electrical and Electronic Equipment (WEEE) Directive 2012/19/EU

The device, as well as all the individual parts, must not be disposed of with household waste or industrial waste. You are obliged to dispose of the device at the end of its service life in accordance with the requirements of RoHS 2012/19/EU to protect the environment and to reduce waste through recycling. For additional information and how to carry out disposal, please contact the certified disposal service providers. The sensors contain a lithium battery, which must be disposed of separately.

Contents

- 1. Description 1
 - 1.1 Dimensions (mm) 1
 - 1.2 Label..... 2
 - 1.3 Main features of the ERS2 series 3
- 2. Mounting guidelines 4
 - 2.1 Motion PIR..... 4
 - 2.2 Room occupancy sensor 4
 - 2.3 Sound level..... 4
- 3. Installation 5
- 4. Service and maintenance..... 6
- 5. Sensor configuration..... 7
 - 5.1 NFC Configuration 7
 - 5.2 Over the air configuration..... 8
 - 5.3 Application parameters 8
- 6. Sensor behavior..... 9
 - 6.1 Sensor startup 9
 - 6.2 Sampling mode / Periodic measurement..... 9
 - 6.3 Scheduled transmission 9
 - 6.4 LED indication 10
- 7. Internal sensors 11
 - 7.1 Temperature..... 12
 - 7.2 Humidity..... 12
 - 7.3 Light 13

7.4	CO2	13
7.5	Motion PIR.....	13
7.5.1	PIR Lens detection pattern.....	14
7.6	Room occupancy (ERS2 Eye)	15
7.6.1	Detailed description.....	15
7.6.2	Special functions for ERS2 Eye.....	15
7.7	Sound level.....	16
7.8	VOC	16
8.	Device specifications	17
9.	Sensor payload format	18
10.	Regulations	18
10.1	Legal Notices	18
10.2	Declaration of conformity	18
11.	Revision History	19

1. Description

The ERS2 series of sensors are universal LoRaWAN® indoor climate sensors. The sensor measures, depending on model, temperature, humidity, light intensity, CO2-level, sound-level, volatile organic compounds (VOC), occupancy and detects motion. ERS2 is a battery-powered device and is designed to be wall-mounted. The sensors are equipped with NFC (Near Field Communication) for easy configuration with an NFC-enabled smartphone.

1.1 Dimensions (mm)

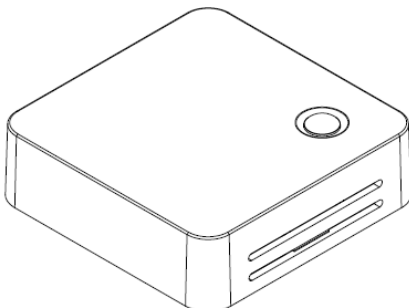
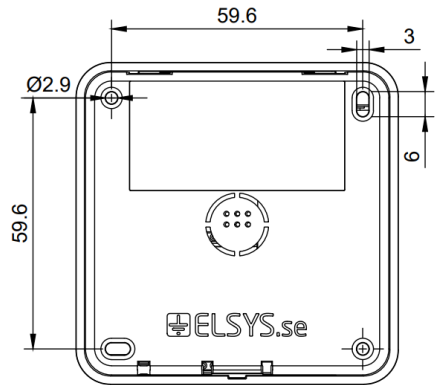
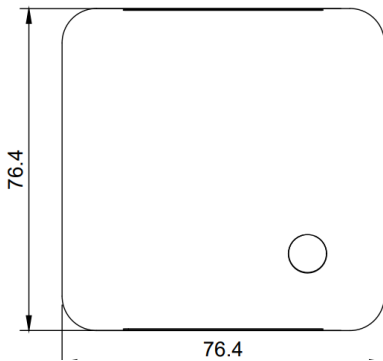
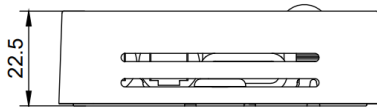

LED Motion detector

Light sensor

1.2 Label

At the back of your device there is a label with an Aztec barcode containing DevEUI and sensor type.



1.3 Main features of the ERS2 series

- Compatible with LoRaWAN® specification 1.0.4
- Measures ambient temperature
- Measures ambient humidity
- Measures light intensity*
- Measures CO2 level*
- Measures sound level*
- Measures VOC level*
- Detects room occupancy*
- Detects motion using a passive IR sensor*
- Indicates low, normal or high values with an LED light*
- Easy installation
- Easy configuration
- May be installed on a wall or any (non-metallic) surface
- Battery-powered
- Long-range communication
- Configurable over NFC
- Configurable over the air
- Ten years of battery life**
- Supported channel plans: EU863-870, IN865, US902-928, AU915-928, AS923, KR920-923, HK923
- CE Approved and RoHS compliant

** Depending on model*

*** Depending on settings and environmental factors*

2. Mounting guidelines

Common mounting guidelines for ERS2 line of sensors:

- Place the sensor in an open space on the wall, with an installation height of 1.6 meters (does not apply to ERS2 Eye, see 4.2).
- For best RF and measurement performance, make sure you mount the sensor with the ventilation openings vertically.
See installation in chapter 2.
- Make sure that the sensor is not placed in direct sunlight, close to heating vents, near windows, air ventilation where it may measure values that is not representative for the rest of the room.

2.1 Motion PIR

The PIR can self-trigger if sensors are placed too close to each other. Keep this in mind when you mount or test the sensors.

2.2 Room occupancy sensor

The Grid Eye sensor has an 8x8 temperature matrix with a field of view of 60° and a range of 5 meters for detecting humans. Keep this in mind when you place the sensor and make sure that you have enough sensors to cover your whole desired area. Preferably place the ERS Eye in the ceiling at between 2.2 to 5 meters height. Do not place the sensor so it faces windows or moving heat sources as this can cause a false positive reading.

2.3 Sound level

Think carefully about the placement of the ERS2 Sound. If the sensor is placed close to loud sources such as machines or ventilation, it will be reflected in the sensor readings due to sounds being louder close to the source.

3. Installation

1. Remove the back panel of the sensor by gently prying the tab with a small screwdriver.



2. Install the batteries. The ERS2 requires one or two AA batteries. The battery type is 3.6V Lithium Battery (ER14505). You can use one battery, but it's recommended that you use two for best battery life. Use battery slot A if only one battery is used.

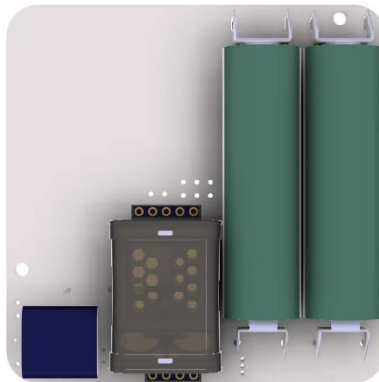

***Caution:** Using batteries other than the ones provided may result in loss of performance, battery life, and also damage to the device. Dispose of properly, observing environmental protection rules.*

3. Mount the back panel securely to the wall with at least 2 appropriate screws, using some of the four mounting holes. Alternatively, attach the sensor with double sided adhesive tape.



4. Attach the sensor part by hinging it on the back panel.

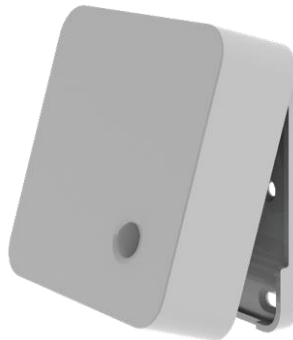

4. Service and maintenance

No serviceable parts inside. If service is needed other than battery replacement, please contact your distributor.

5. Sensor configuration

All sensor settings can be configured via a smartphone application with NFC (Near Field Communication) or over the air via the network server and downlink data to the sensor. The sampling rate, spreading factor, encryption keys, port, and modes can be changed. All sensor settings can be locked from the server or NFC to make end-users unable to read or change settings on the sensor.

5.1 NFC Configuration

1. Download ELSYS "Sensor Settings" application from Google Play or App store and install it on a smartphone or tablet. The device must support NFC.
2. Enable NFC on the device and start the application.
3. Place your device on top of the NFC antenna on the sensor. Keep the two devices close to each other and don't move them to get as good connectivity as possible.
4. Remove the device. Current settings will be displayed in the application.

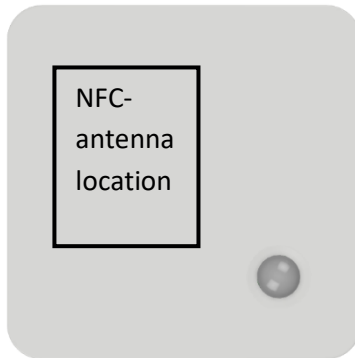

5. Use the application to change any settings if needed.
6. Tap the device on top of the NFC antenna to transfer the new settings to the sensor. Make sure that the application confirms your new settings.
7. Wait for the sensor to reboot (1 sec), indicated by the LED flashing. Sensor settings have been updated. Always validate your settings by reading the NFC data after the sensor has restarted.

5.2 Over the air configuration

All settings may be configured over the air via your LoRaWAN® infrastructure. Please visit the support section on our webpage for more information regarding downlink protocol.

5.3 Application parameters

All parameters for the “Sensor settings” application can be found in our settings document. Please visit the support section on our webpage for more information.

6. Sensor behavior

6.1 Sensor startup

1. When the sensor starts up it loads any configuration parameters written to the NFC chip. The sensor will then write all configuration parameters back to the NFC chip.

2. When the configuration is done the sensor tries to join the network if OTAA (Over the Air Activation) is enabled. Make sure that the sensor credentials (DevEUI, AppKey, JoinEUI) match the keys added in the server for activation of the device. The join procedure starts at spreading factor 7 with a join request every ~15 seconds. The sensor will gradually increase the time as well as the Spreading Factor between the following join requests until the join is successful. Every join request is indicated by a yellow LED blink.

3. After successful connection to a network, the sensor sends an uplink containing the sensor settings and enters sampling mode.

6.2 Sampling mode / Periodic measurement

The sensor makes periodic measurements according to the user configuration.

6.3 Scheduled transmission

The sensor transmits data according to the user configuration. However, the configured sending interval can be overridden by network limitations. Due to this, the spreading factor and sending interval settings might result in longer intervals than intended.

6.4 LED indication

The LED, located in the bottom right corner, indicates different actions when the sensor is active.

LED indication	Action
Long red blink, long green blink	Sensor is starting up
Short yellow blink	LoRa join request transmission
Short green blink	LoRa uplink transmission
Short red blink	Sensor failed to send an uplink Common cause is duty cycle limits
Long blue blink	Sensor has loaded new configuration from NFC

7. Internal sensors

The populated internal sensors in the ERS2 series differ between models according to the list below.

	ERS2	ERS2 Lite	ERS2 CO2	ERS2 CO2 Lite	ERS2 Eye	ERS2 Sound	ERS2 VOC
Temperature	✓	✓	✓	✓	✓	✓	✓
Humidity	✓	✓	✓	✓	✓	✓	✓
Light	✓		✓		✓	✓	✓
Motion PIR	✓		✓		✓	✓	✓
CO2			✓	✓			
Room occupancy					✓		
Sound level						✓	
VOC							✓
NFC	✓	✓	✓	✓	✓	✓	✓

7.1 Temperature

Resolution: 0.1 °C

Accuracy: 0.2 °C typical, see figure

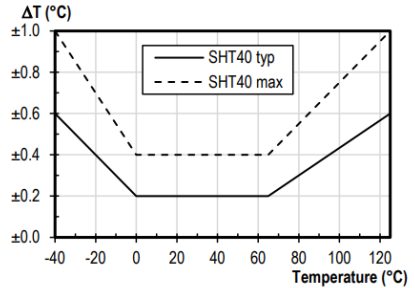

7.2 Humidity

Resolution: 1 % RH

Accuracy at 25 °C: ±2 % RH, see figure

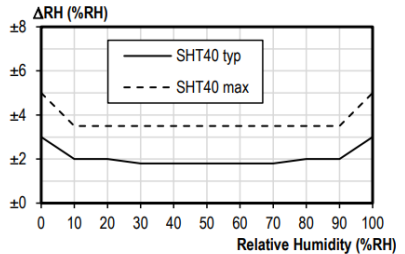

Accuracy of RH over temp.: See figure

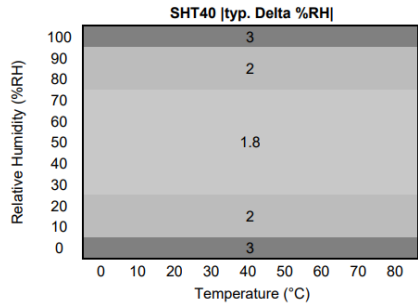

7.3 Light

The light sensor sits behind the PIR lens. For correct reading, make sure it isn't obstructed. Accuracy can depend on angle of light source.

Range: 0-65535 lux

Accuracy: $\pm 10\%$ or ± 10 lux, whichever is greater.

7.4 CO2

The CO2 sensor normally runs an automatic baseline correction algorithm (ABC), with a period of 8 days. For a fully corrected measurement, the ABC needs 3 consecutive 8-day periods where the sensor sees fresh air (400 ppm) sometime during each ABC period. It can also be calibrated manually, and the ABC can be turned off. In this case it is recommended to do a manual calibration in fresh air once/year.

Range: 400-10000 ppm

Accuracy:

400-5000 ppm: ± 30 ppm, $\pm 3\%$ of reading (15-35 °C, 0-80 % RH)

5001-10000 ppm: $\pm 10\%$ of reading (15-35 °C, 0-80 % RH)

7.5 Motion PIR

Motion detection range. Actual range of the sensor can be influenced by environmental conditions. See mounting guidelines in chapter 4.

Note: The PIR has a blanking time of 8 seconds right after motion event and transmission. Any movements during this time will be ignored.

7.5.1 PIR Lens detection pattern

Lens for ERS2, ERS2 CO2, ERS2 Sound and ERS2 VOC (wall mount)

From side

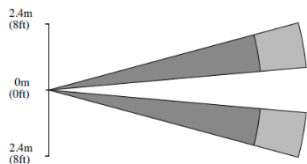

From top

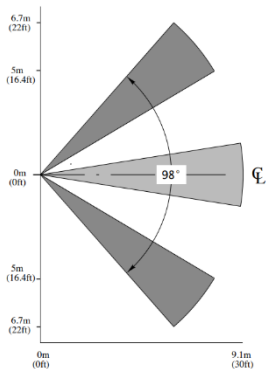

Lens for ERS2 Eye (ceiling mount)

From side

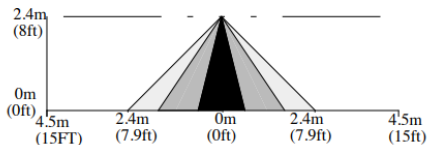

From top

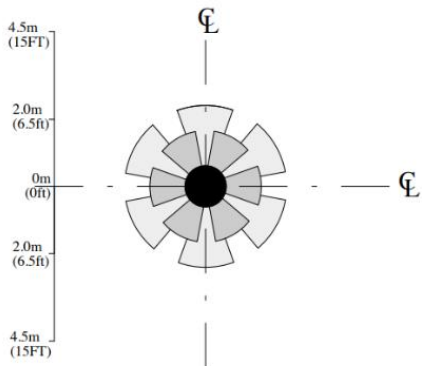

7.6 Room occupancy (ERS2 Eye)

The room occupancy algorithm uses both the PIR sensor and an 8x8 pixel heat map sensor. If the PIR triggers, occupancy is detected. If the PIR doesn't trigger, the heat map is enabled, and its pattern is compared to a filtered mean value of the room. If there is a big enough difference between the two, occupancy is detected. *Please allow for up to 24 hours for the algorithm to stabilize after installation.*

7.6.1 Detailed description

When the PIR is triggered, room occupancy is set to 1. If no other motion is detected within 5 minutes, the sensor captures a heat map image. Room occupancy is set to 2 if heat signatures are detected, otherwise, room occupancy is set to 0 and a new background image is calibrated.

Whenever the occupancy value is changed, the ERS2 Eye will trigger a transmission. No triggered transmission will be done as long as the occupancy value remains unchanged. Periodic transmissions will send all values, including occupancy.

Examples of occupancy values:

- Occupancy 0: Unoccupied.
- Occupancy 1: Occupied. Occupancy detected by motion.
- Occupancy 2: Occupied. Occupancy detected by heat signatures.

Heat map viewing angle: 60°x60°

Heat map accuracy (typical): $\pm 2.5^{\circ}\text{C}$

7.6.2 Special functions for ERS2 Eye

Hot spot: Reports highest temperature pixel.

Raw data: Reports all 8x8 pixel temperature data.

Note: The heat map will also detect other warm objects (e.g., laptops). Warm objects that stay in the same place will eventually be calculated into the background image.

7.7 Sound level

The sound level sensor continuously measures the average and peak sound pressure level with no missing events. The analog part is always on, with a peak-hold circuit for peak level, and a mean-value filtering for average value. The digital part wakes and samples both signals every 10 s and does the final calculation before sending the data at the desired send interval.

Average value range: 31 – 75 dB SPL

Peak value range: 59 – 100 dB SPL

Filtering: dBA

Sound resolution: 1 dB

Sound accuracy: ± 5 dB

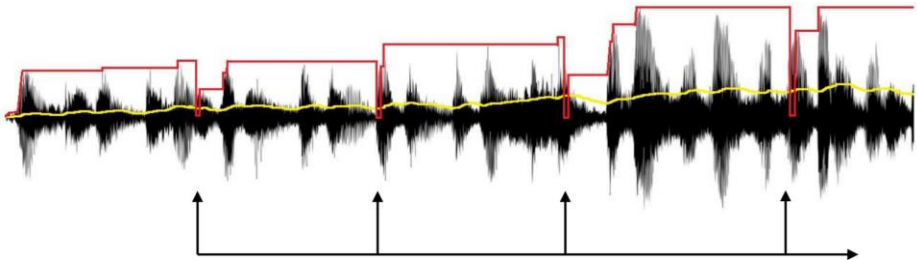

10s sample and peak reset. For every send interval, the ERS Sound calculates total peak and average for all samples. Red = peak, yellow = average.

7.8 VOC

Resolution:

0 ppb – 2008 ppb:	1 ppb
2008 ppb – 11110 ppb:	6 ppb
11110 ppb – 60000 ppb:	32 ppb

Accuracy: 15 % of measured value (typical), 40% (max)

Measurement range: 0 – 60000 ppb TVOC

8. Device specifications

Mechanical specifications	
Dimensions	76,4 x 76,4 x 22.5 mm
Weight	53 – 60 g excluding batteries / 70 – 95 g including batteries (<i>depending on model</i>)
Enclosure	Plastic, PC / ABS
IP rating	IP20
Mounting	Screws / Adhesive tape
Recommended installation height	1.6 m – Wall 2.2m – Ceiling, only ERS2 Eye
Operating conditions	
Usage environment	Indoor
Temperature	0 to 50 °C
Humidity	0 to 85 % RH (non-condensing)
Power supply	
Operating voltage	3.6V DC
Battery type	AA 14505 (Li-SOCl ₂)
Battery life	Up to 10 years (<i>Depending on settings and environmental factors</i>).
Radio / wireless	
Wireless technology	LoRaWAN® 1.0.4, Regional Parameters RP2 - 1.0.3
Wireless security	LoRaWAN® End-to-End encryption (AES-CTR), Data Integrity Protection (AES-CMAC)
LoRaWAN® Device Type	Class A End-device
Supported LoRaWAN® features	OTAA, ABP, ADR, Adaptive Channel Setup
Supported LoRaWAN® regions	EU868, IN865, US915, AU915, AS923, KR923, HK923
Link budget	137dB (SF7) to 151 dB (SF12)
RF Transmit Power	Max 14 dBm EIRP
EU directives compliance	RED 2014/53/EU, RoHS 2011/65/EU WEEE 2012/19/EU

9. Sensor payload format

The device uses the standard ELSYS payload format. Please see the specified document on our webpage.

10. Regulations

10.1 Legal Notices

All information, including, but not limited to, information regarding the features, functionality, and/or other product specification, are subject to change without notice. ELSYS reserves all rights to revise or update its products, software, or documentation without any obligation to notify any individual or entity. ELSYS and ELSYS logo are trademarks of ElektronikSystem i Umeå AB. All other brands and product names referred to herein are trademarks of their respective holders.

10.2 Declaration of conformity

Hereby, ElektronikSystem i Umeå AB declares that the radio equipment type Radio communication devices for low-speed data R&TTE Class 1 is in compliance with Directive 2014/53/EU, Directive 2011/65/EU and Directive 2012/19/EU.

The full text of the EU declaration of conformity is available at:

<https://www.elsys.se/link/eu-doc>

11. Revision History

Revision	Description	Date
1.0	ERS2 series manual created	2023-01-26