

LoRa Gateway

4G IIoT LoRa Gateway

IOG851-0TL01 - w/o Internal NS

IOG851-0TL02 - with Internal NS



4G IIoT LoRa Gateway

Chapter 1 Introduction.....	7
1.1 Introduction	7
1.2 Contents List.....	8
1.2.1 Package Contents	8
1.3 Hardware Configuration.....	9
1.4 LED Indication	11
1.5 Installation & Maintenance Notice	12
1.5.1 SYSTEM REQUIREMENTS.....	12
1.5.2 WARNING	12
1.5.3 HOT SURFACE CAUTION	14
1.5.4 Product Information for CE RED Requirements	15
1.6 Hardware Installation.....	17
1.6.1 Mount the Unit	17
1.6.2 Insert the SIM Card	17
1.6.3 Install the External RF Cable and Antenna.....	18
1.6.4 Connecting Serial Devices.....	19
1.6.5 Connecting DI/DO Devices.....	20
1.6.6 Connecting Power	21
1.6.7 Power Supply Installation.....	22
1.6.8 Connecting to the Network or a Host.....	24
1.6.9 Setup by Configuring WEB UI.....	24
Chapter 2 Basic Network.....	25
2.1 WAN & Uplink	25
2.1.1 Physical Interface	26
2.1.2 Internet Setup	31
2.1.3 Load Balance	51
2.2 LAN & VLAN.....	56
2.2.1 Ethernet LAN.....	56
2.2.2 VLAN.....	59
2.2.3 DHCP Server	72

4G IIoT LoRa Gateway

2.3 WiFi (not supported).....	80
2.4 IPv6.....	81
2.4.1 IPv6 Configuration.....	81
2.5 Port Forwarding.....	89
2.5.1 Configuration.....	90
2.5.2 Virtual Server & Virtual Computer.....	91
2.5.3 DMZ & Pass Through.....	97
2.5.4 Special AP & ALG.....	100
2.6 Routing.....	104
2.6.1 Static Routing.....	105
2.6.2 Dynamic Routing.....	108
2.6.3 Routing Information.....	117
2.7 DNS & DDNS.....	118
2.7.1 DNS & DDNS Configuration.....	118
2.8 QoS.....	122
2.8.1 QoS Configuration.....	122
2.9 Redundancy.....	131
2.9.1 VRRP.....	131
Chapter 3 Object Definition.....	134
3.1 Scheduling.....	134
3.1.1 Scheduling Configuration.....	134
3.2 User (not supported).....	136
3.3 Grouping.....	137
3.3.1 Host Grouping.....	137
3.4 External Server.....	139
3.5 Certificate.....	142
3.5.1 Configuration.....	142
3.5.2 My Certificate.....	145
3.5.3 Trusted Certificate.....	152
3.5.4 Issue Certificate.....	159

4G IIoT LoRa Gateway

Chapter 4 Field Communication	162
4.1 Bus & Protocol.....	162
4.1.1 Port Configuration.....	162
4.1.2 Virtual COM.....	164
4.1.3 Modbus	174
4.2 Data Logging.....	184
4.2.1 Data Logging Configuration.....	187
4.2.2 Scheme Setup.....	189
4.2.3 Log File Management.....	191
4.3 Data Interchange.....	193
4.3.1 MQTT.....	193
Chapter 5 Security.....	205
5.1 VPN.....	205
5.1.1 IPSec	206
5.1.2 OpenVPN.....	215
5.1.3 L2TP.....	228
5.1.4 PPTP	236
5.1.5 GRE.....	243
5.2 Firewall.....	248
5.2.1 Packet Filter.....	248
5.2.2 URL Blocking.....	253
5.2.3 MAC Control.....	257
5.2.4 Content Filter (not supported).....	260
5.2.5 Application Filter (not supported)	261
5.2.6 IPS.....	262
5.2.7 Options.....	266
Chapter 6 Administration.....	270
6.1 Configure & Manage	270
6.1.1 Command Script.....	271
6.1.2 TR-069	275

4G IIoT LoRa Gateway

6.1.3	SNMP	280
6.1.4	Telnet & SSH	291
6.2	System Operation	295
6.2.1	Password & MMI	295
6.2.2	System Information	299
6.2.3	System Time	300
6.2.4	System Log	305
6.2.5	Backup & Restore	310
6.2.6	Reboot & Reset	311
6.3	FTP	312
6.3.1	Server Configuration	313
6.3.2	User Account	315
6.4	Diagnostic	316
6.4.1	Diagnostic Tools	316
6.4.2	Packet Analyzer	318
Chapter 7	Service	321
7.1	Cellular Toolkit	321
7.1.1	Data Usage	322
7.1.2	SMS	325
7.1.3	SIM PIN	329
7.1.4	USSD	334
7.1.5	Network Scan	337
7.2	SMS & Event	339
7.2.1	Configuration	341
7.2.2	Managing Events	351
7.2.3	Notifying Events	354
7.3	LoRa	357
7.3.1	LoRa Gateway	359
7.3.2	LoRa Network Server	361
7.3.3	Application Server	367

4G IIoT LoRa Gateway

7.3.4 LoRa Node Log	369
Chapter 8 Status.....	370
8.1 Dashboard	370
8.1.1 Device Dashboard	370
8.2 Basic Network	372
8.2.1 WAN & Uplink Status	372
8.2.2 LAN & VLAN Status.....	376
8.2.3 WiFi Status (not supported).....	377
8.2.4 DDNS Status	378
8.3 Security.....	379
8.3.1 VPN Status.....	379
8.3.2 Firewall Status	384
8.4 Administration.....	388
8.4.1 Configure & Manage Status	388
8.4.2 Log Storage Status.....	391
8.5 Statistics & Report.....	392
8.5.1 Connection Session	392
8.5.2 Network Traffic.....	393
8.5.3 Login Statistics.....	394
8.5.4 Cellular Usage.....	395
Appendix A GPL WRITTEN OFFER	396

Chapter 1 Introduction

1.1 Introduction

Congratulations on your purchase of this outstanding product: 4G IIoT LoRa Gateway (*¹). For IIoT LoRa applications, AMIT LoRa Gateway is absolutely the right choice. With built-in 8-channel LoRa interface, your deployed LoRa end-nodes can easily connected to the LoRa gateway, and even network server/application server as well. Your customer application server can access to the data transferred from the end-nodes, and further make adequate control on your needs.

With a built-in world-class 4G LTE module, you just need to insert SIM card from local mobile carrier to get to Internet. The dual SIM design provides a more reliable WAN connection for critical applications. By VPN tunneling technology, remote sites easily become a part of Intranet, and all data are transmitted in a secure (256-bit AES encryption) link. The feature of DI/DO allows gateway to have real-time response whenever events are detected by sensors.

Main Features:

- Built-in high speed LTE modem with dual SIMs for uplink traffic failover.
- Embedded an 8-channel LoRa gateway module for connecting with multiple LoRa nodes.
- LoRaWAN Compliance gateway, forward received LoRa packets to external public network server, or optional internal private network server.
- Equip gigabit Ethernet ports to connect other IP-based devices.
- RS232/485 serial port for controlling legacy serial devices or Modbus devices.
- Digital I/O ports for integrating sensors, switch, or other alarm devices.
- Designed by solid and easy-to-mount metal body for industrial environment to work with a variety M2M (Machine-to-Machine) applications.

Before you install and use this product, please read this manual in detail for fully exploiting the functions of this product.





¹ IOG851-0TL01 for LoRa Gateway, w/o network server; IOG851-0TL02 for LoRa Gateway with internal Network Server..

4G IIoT LoRa Gateway

1.2 Contents List

1.2.1 Package Contents

#Standard Package

Items	Description	Contents	Quantity
1	I0G851-0TL0x 4G IIoT LoRa Gateway(*²)		1pcs
2	8 pin Terminal Block		1pcs
3	4 pin Terminal Block		1pcs
4	RJ45 Cable		1pcs
5	DIN-Rail Bracket		1pcs

² The maximum power consumption of IOG851 series product is 20.0W.

4G IIoT LoRa Gateway

1.3 Hardware Configuration

➤ Front View

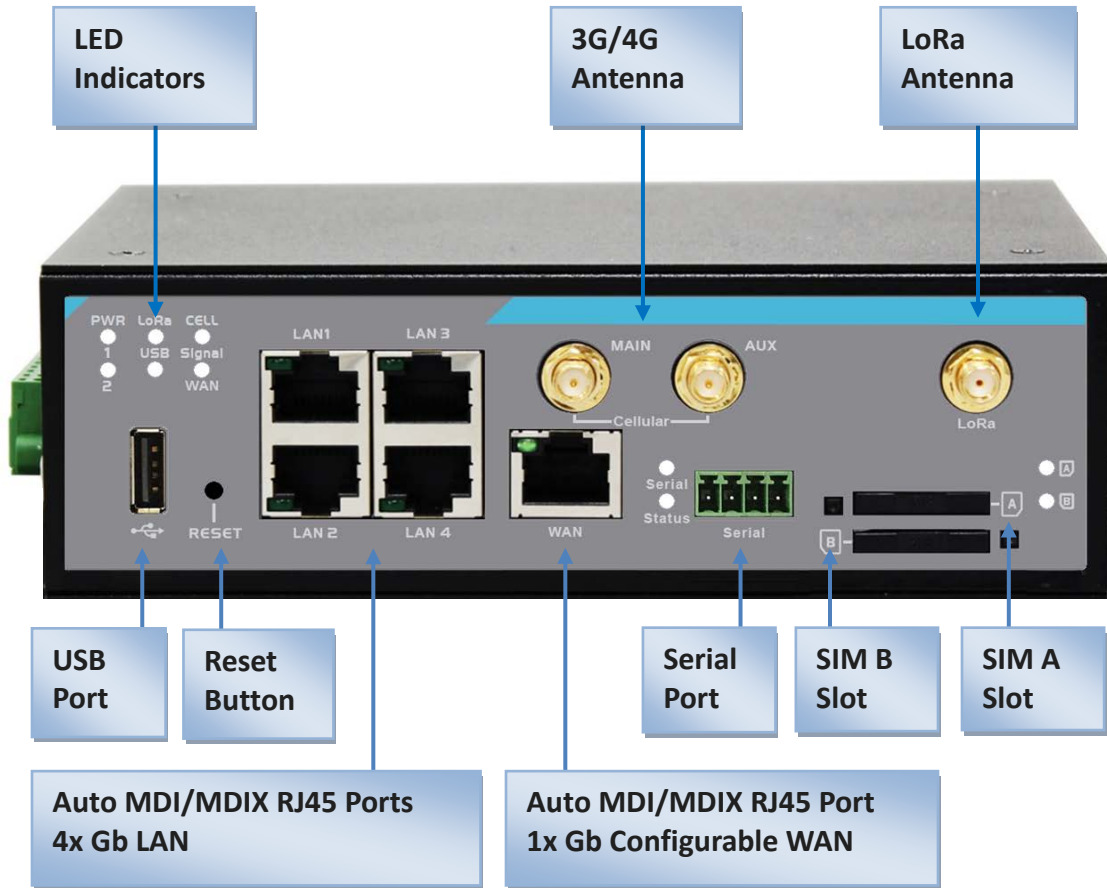

⌘ Reset Button

The RESET button provides user with a quick and easy way to resort the default setting. Press the RESET button continuously for 6 seconds, and then release it. The device will restore to factory default settings.

⌘ 3G/4G, LoRa Antenna

All the 3G/4G and LoRa antennas are optional accessory, and not included in the standard package. You need to purchase the suitable antennas and required RF cables to fit your application.

4G IIoT LoRa Gateway



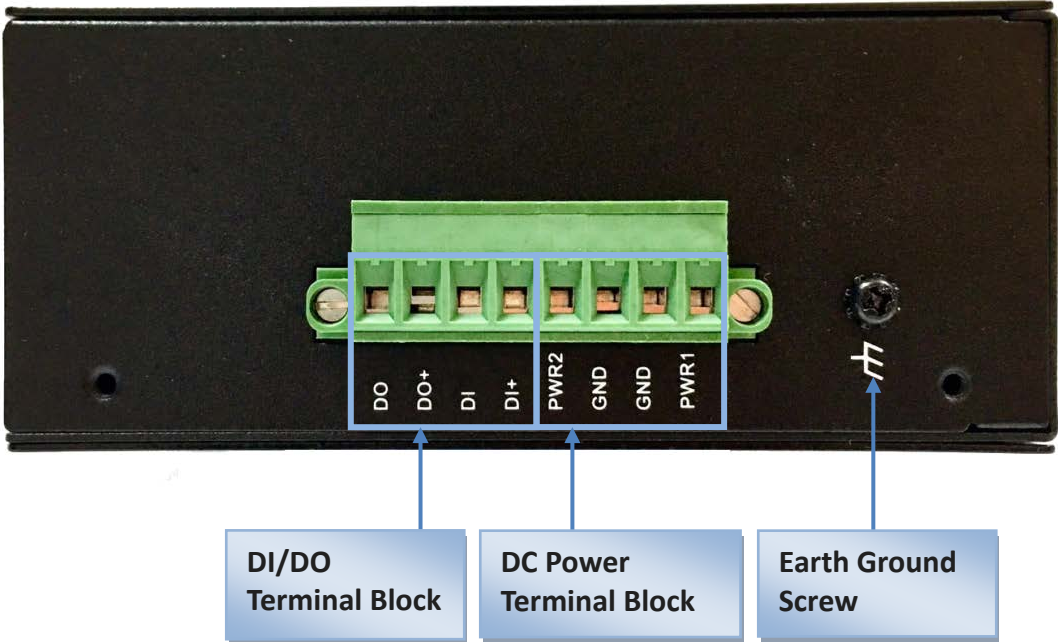

➤ Left View



4G IIoT LoRa Gateway

1.4 LED Indication



LED Icon	Indication	LED Color	Description
	Power Source 1	Blue	Steady ON: Device is powered on by power source 1
	Power Source 2	Blue	Steady ON: Device is powered on by power source 2
LoRa	LoRa	Blue	OFF: LoRa is disabled Steady ON: LoRa is enabled In Flashing : while data packet transferred via LoRa connection
USB	USB	Blue	Steady ON: If USB device is attached
Signal	Signal (Cellular)	Blue	Steady On : Signal Strength is 61~100% Slow Flash(per Second) : Signal Strength is 31~60% Fast Flash(per 0.5 second) : Signal Strength is 0~30%
WAN	WAN (Cellular)	Blue	OFF : No data packet transferred via Cellular interface In Flashing : while data packet transferred via Cellular interface
	LAN 1 ~ LAN 4/WAN	Green	Steady ON: Ethernet connection of LAN or WAN is established. Flash: Data packets are transferring. OFF: No Ethernet cable attached or Device not linked.
Serial	Serial	Blue	Steady ON: If serial device is attached
Status	Status	Blue	Steady ON: Device is powered on OFF: Device is powered off
	SIM A / B	Blue	OFF : SIM doesn't detect Slow Flash(per Second) : SIM A/B was chosen to do the connection Steady ON : Cellular connection already established successful (under SIM A/B)

4G IIoT LoRa Gateway

1.5 Installation & Maintenance Notice

1.5.1 SYSTEM REQUIREMENTS

Network Requirements	<ul style="list-style-type: none">• An gigabit Ethernet RJ45 cable• 3G/4G cellular service subscription• 10/100/1000 Ethernet adapter on PC
Web-based Configuration Utility Requirements	Computer with the following: <ul style="list-style-type: none">• Windows®, Macintosh, or Linux-based operating system• An installed Ethernet adapter Browser Requirements: <ul style="list-style-type: none">• Internet Explorer 6.0 or higher• Chrome 2.0 or higher• Firefox 3.0 or higher• Safari 3.0 or higher

1.5.2 WARNING



Attention

- Only use the power supply that complies with the power specification of the gateway. Using an out-of-spec voltage rating power source is dangerous and may damage the product.
- Do not open or repair the case yourself. If the product is too hot, turn off the power immediately and have it repaired at a qualified service center.

4G IIoT LoRa Gateway

Federal Communication Commission Interference Statement

This device complies with Part 15 of the FCC Rules. Operation is subject to the following two conditions: (1) This device may not cause harmful interference, and (2) this device must accept any interference received, including interference that may cause undesired operation.

This equipment has been tested and found to comply with the limits for a Class B digital device, pursuant to Part 15 of the FCC Rules. These limits are designed to provide reasonable protection against harmful interference in a residential installation. This equipment generates, uses and can radiate radio frequency energy and, if not installed and used in accordance with the instructions, may cause harmful interference to radio communications. However, there is no guarantee that interference will not occur in a particular installation. If this equipment does cause harmful interference to radio or television reception, which can be determined by turning the equipment off and on, the user is encouraged to try to correct the interference by one of the following measures:

- Reorient or relocate the receiving antenna.
- Increase the separation between the equipment and receiver.
- Connect the equipment into an outlet on a circuit different from that to which the receiver is connected.
- Consult the dealer or an experienced radio/TV technician for help.

FCC Caution: Any changes or modifications not expressly approved by the party responsible for compliance could void the user's authority to operate this equipment.

This transmitter must not be co-located or operating in conjunction with any other antenna or transmitter.

FOR PORTABLE DEVICE USAGE (<20m from body/SAR needed)

Radiation Exposure Statement:

The product comply with the FCC portable RF exposure limit set forth for an uncontrolled environment and are safe for intended operation as described in this manual. The further RF exposure reduction can be achieved if the product can be kept as far as possible from the user body or set the device to lower output power if such function is available.

FOR MOBILE DEVICE USAGE (>20cm/low power)

Radiation Exposure Statement:

This equipment complies with FCC radiation exposure limits set forth for an uncontrolled environment. This equipment should be installed and operated with minimum distance 20cm between the radiator & your body.

FOR COUNTRY CODE SELECTION USAGE (WLAN DEVICES)

Note: The country code selection is for non-US model only and is not available to all US model. Per FCC regulation, all WiFi product marketed in US must fixed to US operation channels only.

1.5.3 HOT SURFACE CAUTION



CAUTION: The surface temperature for the metallic enclosure can be very high! Especially after operating for a long time, installed at a closed cabinet without air conditioning support, or in a high ambient temperature space.

DO NOT touch the hot surface with your fingers while servicing!!

4G IIoT LoRa Gateway

1.5.4 Product Information for CE RED Requirements

The following product information is required to be presented in product User Manual for latest CE RED requirements.³

(1) Frequency Band & Maximum Power

1.a Frequency Band for Cellular Connection (for ME3630 E1C version)⁴

Band number	Operating Frequency	Max output power
LTE FDD BAND 1	Uplink: 1920-1980 MHz Downlink: 2110-2170 MHz	23 ±2.7 dBm
LTE FDD BAND 3	Uplink: 1710-1785 MHz Downlink: 1805-1880 MHz	
LTE FDD BAND 7	Uplink: 2500-2570 MHz Downlink: 2620-2690 MHz	
LTE FDD BAND 8	Uplink: 880-915 MHz Downlink: 925-960 MHz	
LTE FDD BAND 20	Uplink: 832-862 MHz Downlink: 791-821 MHz	
WCDMA BAND 1	Uplink: 1920-1980 MHz Downlink: 2110-2170 MHz	24 +1/-3 dBm
WCDMA BAND 8	Uplink: 880-915 MHz Downlink: 925-960 MHz	
E-GSM	Uplink: 880-915 MHz Downlink: 925-960 MHz	33 ±2 dBm
DCS	Uplink: 1710-1785 MHz Downlink: 1805-1880 MHz	30 ±2 dBm

1.b Frequency Band for Cellular Connection (for EC25-E version)

Band number	Operating Frequency	Max output power
LTE FDD BAND 1	Uplink: 1920-1980 MHz Downlink: 2110-2170 MHz	23.1 dBm
LTE FDD BAND 3	Uplink: 1710-1785 MHz Downlink: 1805-1880 MHz	23.0 dBm
LTE FDD BAND 7	Uplink: 2500-2570 MHz Downlink: 2620-2690 MHz	22.8 dBm
LTE FDD BAND 8	Uplink: 880-915 MHz Downlink: 925-960 MHz	23.2 dBm
LTE FDD BAND 20	Uplink: 832-862 MHz	23.5 dBm

³ The information presented in this section is ONLY valid for the EU/EFTA regional version. For those non-CE/EFTA versions, please refer to the corresponding product specification.

⁴ There can be different cellular module integrated in the device for EU/EFTA regional version. Refer to the cellular module identifier printed on the device label for the purchased device.

4G IIoT LoRa Gateway

	Downlink: 791-821 MHz	
LTE FDD BAND 38	Uplink: 2570-2620 MHz Downlink: 2570-2620 MHz	21.7 dBm
LTE FDD BAND 40	Uplink: 2300-2400 MHz Downlink: 2300-2400 MHz	21.5 dBm
WCDMA BAND 1	Uplink: 1920-1980 MHz Downlink: 2110-2170 MHz	23.3 dBm
WCDMA BAND 8	Uplink: 880-915 MHz Downlink: 925-960 MHz	
E-GSM	Uplink: 880-915 MHz Downlink: 925-960 MHz	32.9 dBm
DCS	Uplink: 1710-1785 MHz Downlink: 1805-1880 MHz	29.9 dBm

1.c Frequency Band for LoRa Connection

Band	Operating Frequency	Max. Output Power (EIRP)
868M	863 - 870MHz	100 mW

(2) DoC Information

You can get the DoC information of this product from the following URL:

<http://www.amit.com.tw/products-doc/>

(3) RF Exposure Statements

The antenna of the product, under normal use condition, is at least 20 cm away from the body of user.

(4) Unit Mounting Notice

The product is suitable for mounting at heights $\leq 2\text{m}$ (approx. 6 ft), or in a cabinet.

Ensure the unit is fixed tightly to reduce the likelihood of injury due to exposure to mechanical hazards if dropped.

(5) Manufacture Information

Manufacture Name: AMIT Wireless Inc.

Manufacture Address: No. 28, Lane 31, Sec. 1, Huandong Rd., Sinshih Dist., Tainan 74146, Taiwan (R.O.C.)

4G IIoT LoRa Gateway

1.6 Hardware Installation

This chapter describes how to install and configure the hardware

1.6.1 Mount the Unit

The IOG851 series product can be mounted on a wall, horizontal plane, or DIN Rail in a cabinet with the mounting accessories (DIN-rail kit or optional brackets). The mounting accessories are not screwed on the product when out of factory. Please screw the DIN-rail bracket or wall-mount kits on the product first.

1.6.2 Insert the SIM Card

WARNING: BEFORE INSERTING OR CHANGING THE SIM CARD, PLEASE MAKE SURE THAT POWER OF THE DEVICE IS SWITCHED OFF.

The SIM card slots are located at the front side of the device housing. You need to push the button and pull the SIM card loader out before installing or removing the SIM card. Please follow the instructions to insert a SIM card. After SIM card is well placed, push the SIM card loader into its slot.

Step 1:
Push the button by a tack to unlock and eject SIM socket.



Step 2:
Put SIM card in the socket firmly.

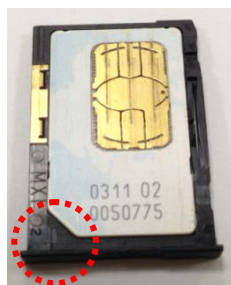

Step 3:
Put back SIM socket into the SIM slot.



4G IIoT LoRa Gateway

1.6.3 Install the External RF Cable and Antenna

As illustrated in Section 1.3, there are several SMA antenna Jacks for you to install the required RF cables and antennas for the RF signal transmission and receiving. You have to purchase required RF cables and antennas separately for a specific project or installation site to get excellent RF performance.

Since there is limited spacing for allocating all SMA antenna Jacks around the enclosure, the separation among SMA Jacks (or direct-attached antennas) could be not the optimized arrangement. **It is not recommended to attach the SMA antennas directly to the SMA Jacks.** It is very likely to get degraded RF performance at specific circumstances. It depends heavily on the environment.

However, there are well-known rules of thumb for solving the antenna separation issue.

- 1: The horizontal distance between antennas should be greater than 1/4 of its wavelength, and there will be best separation at 1/2 of its wavelength.**
- 2. If multiple frequency antennas are near each other, then use spacing distance of the lower frequency antenna, or even better try to satisfy the rule for both frequencies.**

Wavelength Table for Major RF Category

RF Category	Frequency	Wavelength	1/2 Wave Length (Best Separation)	1/4 Wave Length (Good Separation)
WiFi 802.11	5.8GHz	5.2cm	2.6cm	1.3cm
WiFi 802.11	2.4GHz	12.5cm	6.2cm	3.1cm
Cellular LTE	2600MHz	11.5cm	5.8cm	2.9cm
Cellular LTE	2100MHz	14.3cm	7.1cm	3.7cm
Cellular LTE	900MHz	33.3cm	16.6cm	8.3cm
Cellular LTE	700MHz	42.8cm	21.4cm	10.7cm
GPS	1.57GHz	19.0cm	9.5cm	4.7cm

For example, if you have a 900MHz LTE antenna and a WiFi 2.4GHz antenna, you would want them to be separated by at least 8.3cm to get good antenna separation.

So, it is recommended to use some external RF cables to extend and separate the adjacent antennas and get better antenna separation and RF performance, if required.

4G IIoT LoRa Gateway

1.6.4 Connecting Serial Devices

The IOG851 series products provide 4-pin Terminal Block serial port for connecting to your serial device. Connect the serial device to the terminal block with the right pin assignments of RS-232/485 are shown as below.



Pin 1 2 3 4

	Pin1	Pin2	Pin3	Pin4
RS-232	GND	RXD	TXD	GND
RS-485	GND	DATA-	DATA+	GND

4G IIoT LoRa Gateway

1.6.5 Connecting DI/DO Devices

There are one DI and one DO ports together with power terminal block. Please refer to following pin assignment and specification to connect DI and DO devices

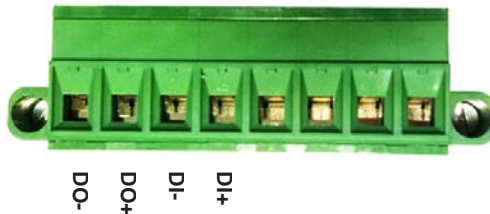

Mode	Specification	
Digital Input	Trigger Voltage (high)	Logic level 1: 5V~30V
	Normal Voltage (low)	Logic level 0: 0V~2V
Digital Output	Voltage (Relay Mode)	Depends on external device maximum voltage is 30V
	Maximum Current	1A

Example of Connection Diagram

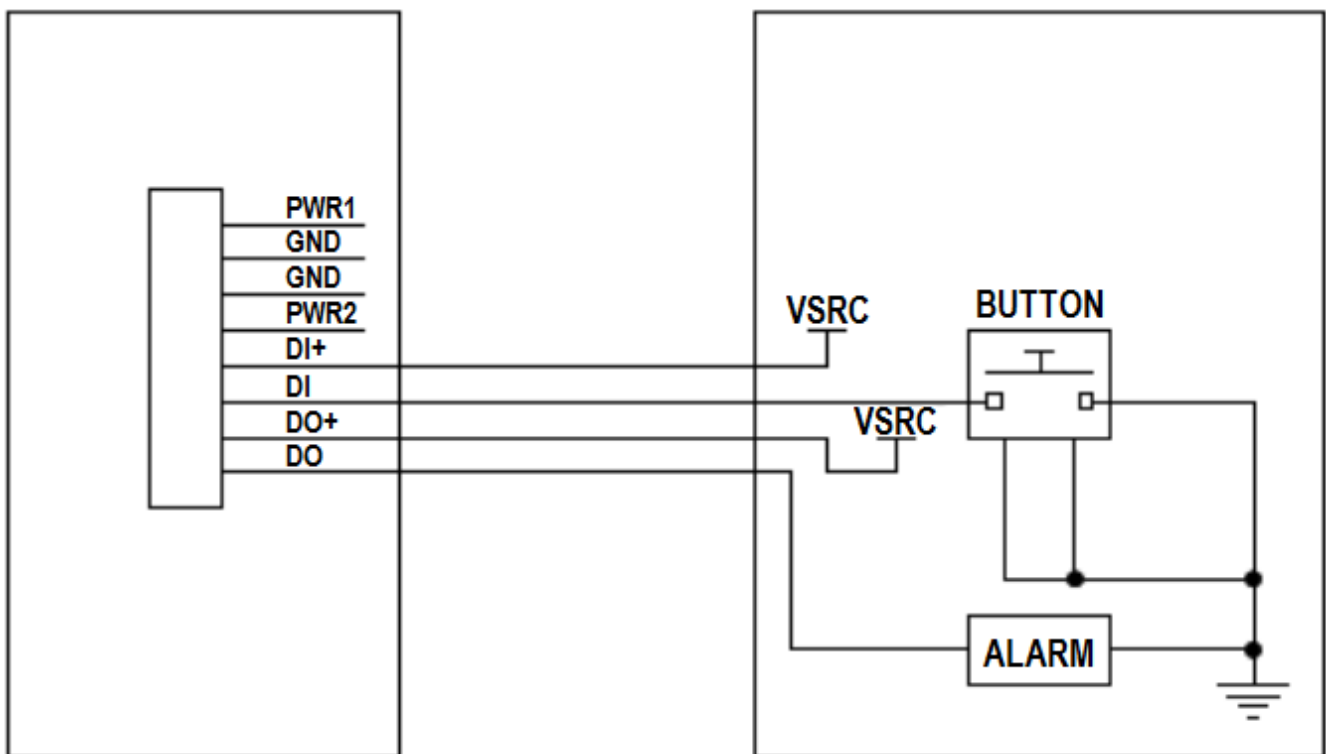

4G IIoT LoRa Gateway

1.6.6 Connecting Power

The IOG851 series product can be powered by connecting one or two power sources to the terminal block. **It supports dual 12 to 48V DC power inputs.** Following picture indicates the power terminal block pin assignments. Please check carefully and connect to the right power requirements and polarity.

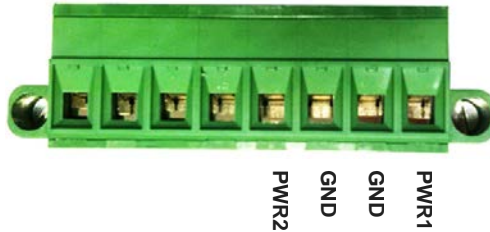

For the dual power supply design on PWR1 and PWR2, the power supply mode can be either primary/backup or concurrent modes. It depends on the voltage for PWR1 and PWR2.

If the voltage difference between PWR1 and PWR2 is greater than 5.0 volt (this is the case for using two power supplies with the different external spec., such as 48V and 24V), the power control circuit works in primary / backup power mode. The one with higher voltage is treated the primary power, and the other one is regarded as a backup power. Normally, only the primary power supplies the required power to the gateway and connected PoE devices; the backup power supply will supply the power to the gateway and connected PoE devices only when the primary power fails.

If the voltage difference between PWR1 and PWR2 is less than 0.5 volt (this is the case for using two power supply with the same external spec., such as 48V), the power control circuit works in concurrent mode. Both PWR1 and PWR2 supply required power to the gateway and connected PoE devices simultaneously.

Note: There may be an ambiguous situation for the voltage difference is less than 5.0 volt, but greater than 0.5 volt. Please be assure that the external power supply can supply enough power that the system required, or you may encounter the ambiguous situation that for some times, one on the power is the primary power, and some times if the loading increased, the power control circuit may switch to concurrent mode that PWR1 and PWR2 supplies power at the same time.

4G IIoT LoRa Gateway

1.6.7 Power Supply Installation

The power supply is an optional unit, is not included in the standard package. You have to purchase or prepare external power supply unit for providing power to the gateway. Hereunder is an example for the Industrial power supply installation.

➤ AC Power Cable Installation

The power supply unit power requirement is 100-240V AC, 50/60Hz with power input lines. AWG 18 power cable is recommended.



The terminal pin number assignment as below

Pin No.	Assignment
1	FG 
2	AC/N
3	AC/L

Please connect the live line, neutral line and earth line to the corresponding location.

➤ DC Power Terminal Block Installation

The Power Supply unit may consist of one set or two sets of DC power output contacts.



You can connect the DC power supply and the terminal block power pins, as shown below, of the gateway with a power cable. AWG 18 power cable is recommended.

4G IIoT LoRa Gateway



Insert DC power wires into the contacts PWR1 or PWR2. The +V connect to PWR and then -V connect to GND. After that, plug in the terminal block to the socket at the side of the gateway.

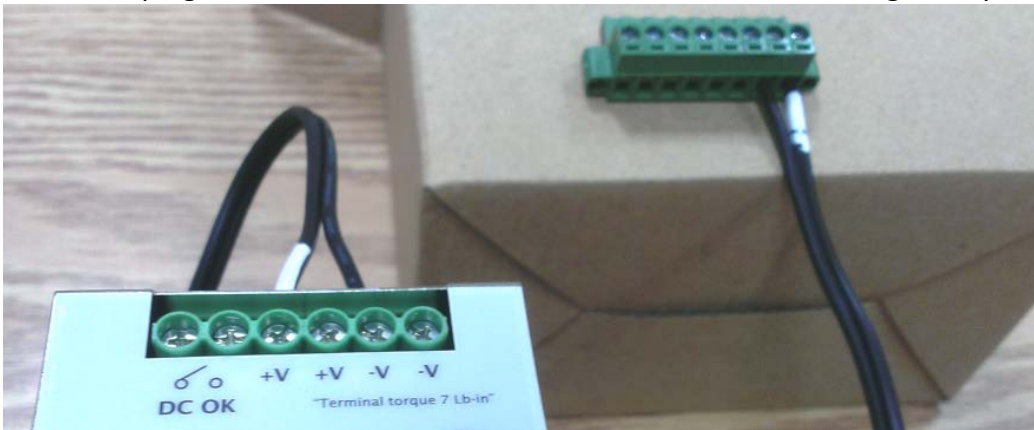

Finally, connect the power plug of the power supply cable to an outlet, then the power supply units will turn on and provide DC power to the connected device.

4G IIoT LoRa Gateway

1.6.8 Connecting to the Network or a Host

The IOG851 series provides RJ45 ports to connect 10/100/1000Mbps Ethernet. It can auto detect the transmission speed on the network and configure itself automatically. Connect one Ethernet cable to the RJ45 port (LAN) of the device and plug another end of the Ethernet cable into your computer's network port. In this way, you can use the RJ45 Ethernet cable to connect to the host PC's Ethernet port for configuring the device.

1.6.9 Setup by Configuring WEB UI

You can browse web UI to configure the device.

Type in the IP Address (<http://192.168.123.254>)⁵



When you see the login page, enter the user name and password and then click '**Login**' button. The default setting for both username and password is '**admin**'⁶.

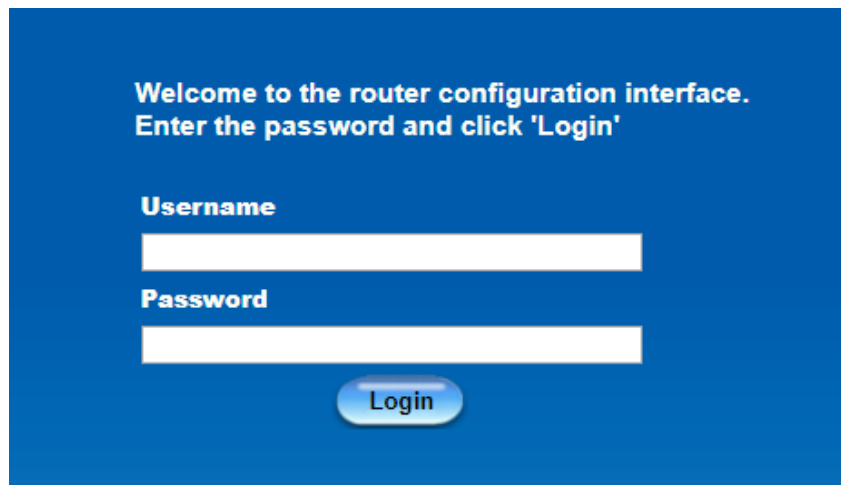

⁵ The default LAN IP address of this gateway is 192.168.123.254. If you change it, you need to login by using the new IP address.

⁶ For security consideration, you are strongly recommended to change the login username and password from default values. Refer to Section 6.1.2 for how to change the setting.

Chapter 2 Basic Network

2.1 WAN & Uplink

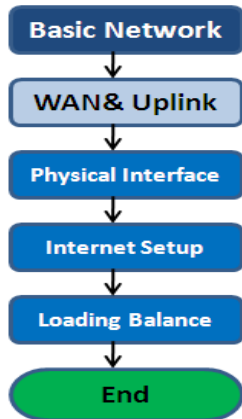

Physical Interface List			
Interface Name	Physical Interface	Operation Mode	Action
WAN-1	Ethernet	Always on	Edit
WAN-2	3G/4G	Always on	Edit
WAN-3	-	Disable	Edit
WAN-4	-	Disable	Edit

The gateway provides multiple WAN interfaces to let all client hosts in Intranet of the gateway access the Internet via ISP. But ISPs in the world apply various connection protocols to let gateways or user's devices dial in ISPs and then link to the Internet via different kinds of transmit media.

So, the WAN Connection lets you specify the WAN Physical Interface, WAN Internet Setup and WAN Load Balance for Intranet to access Internet. For each WAN interface, you must specify its physical interface first and then its Internet setup to connect to ISP. Besides, since the gateway has multiple WAN interfaces, you can assign physical interface to participate in the Load Balance function.

4G IIoT LoRa Gateway

2.1.1 Physical Interface

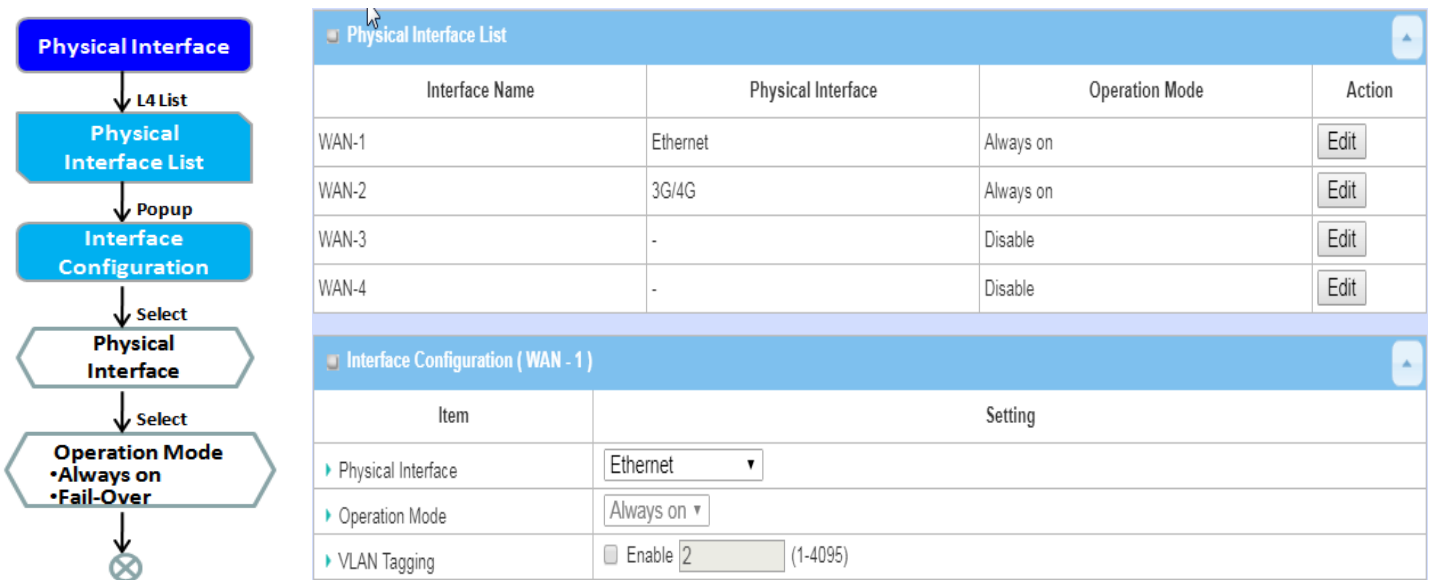

M2M gateways are usually equipped with various WAN interfaces to support different WAN connection scenario for requirement. You can configure the WAN interface one by one to get proper internet connection setup. **Refer to the product specification for the available WAN interfaces in the product you purchased.**

The first step to configure one WAN interface is to specify which kind of connection media to be used for the WAN connection, as shown in "Physical Interface" page.

In "Physical Interface" page, there are two configuration windows, "Physical Interface List" and "Interface Configuration". "Physical Interface List" window shows all the available physical interfaces. After clicking on the "Edit" button for the interface in "Physical Interface List" window the "Interface Configuration" window will appear to let you configure a WAN interface.

Physical Interface:

- **Ethernet WAN:** The gateway has one or more RJ45 WAN ports that can be configured to be WAN connections. You can directly connect to external DSL modem or setup behind a firewall device.
- **3G/4G WAN:** The gateway has one built-in 3G/4G cellular as WAN connection. For each cellular WAN, there are 1 or 2 SIM cards to be inserted for special failover function.



- Please **MUST POWER OFF** the gateway before you insert or remove SIM card.
- The SIM card can be damaged if you insert or remove SIM card while the gateway is in operation.

4G IIoT LoRa Gateway

Operation Mode:

There are three option items "Always on", "Failover", and "Disable" for the operation mode setting.

Always on: Set this WAN interface to be active all the time. When two or more WAN are established at "Always on" mode, outgoing data will through these WAN connections base on load balance policies.

Failover:

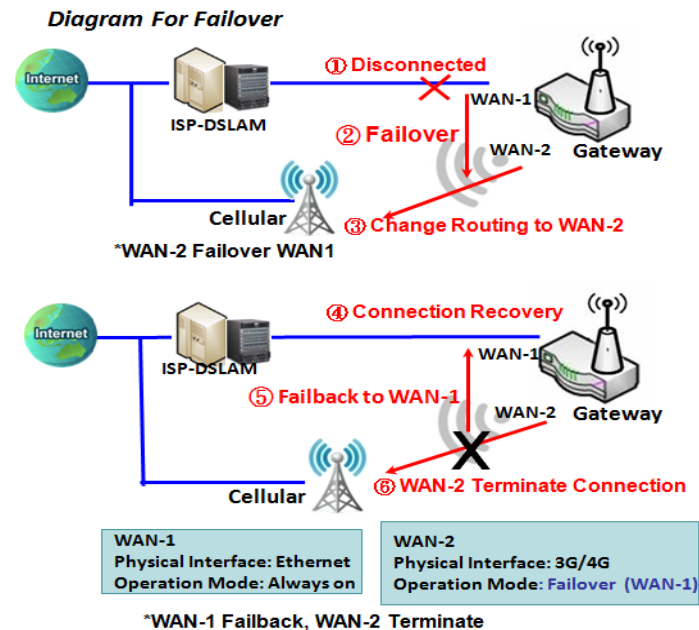

A failover interface is a backup connection to the primary. That means only when its primary WAN connection is broken, the backup connection will be started up to substitute the primary connection. As shown in the diagram, WAN-2 is backup WAN for WAN-1. WAN-1 serves as the primary connection with operation mode "Always on". WAN-2 won't be activated until WAN-1 disconnected. When WAN-1 connection is recovered back with a connection, it will take over data traffic again. At that time, WAN-2 connection will be terminated.

Seamless Failover:

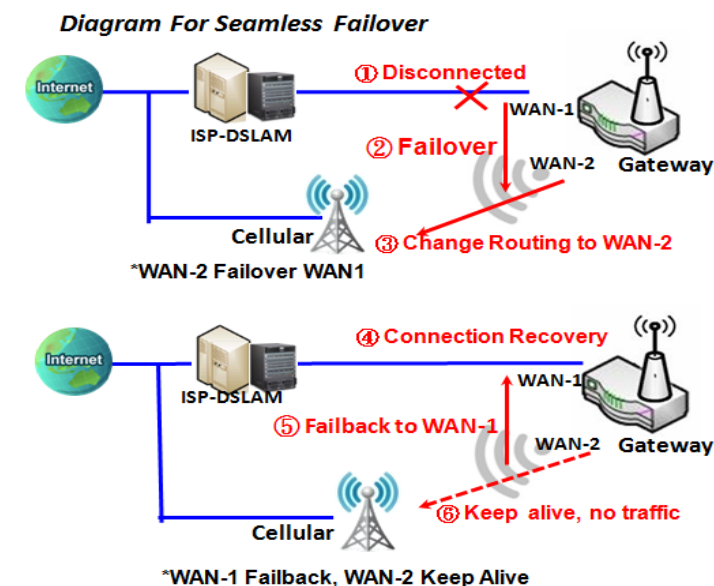

In addition, there is a "Seamless" option for Failover operation mode. When seamless option is activated by checking on the "Seamless" box in configuration window, both the primary connection and the failover connection are started up after system rebooting. But only the primary connection executes the data transfer, while the failover one just keeps alive of connection line. As soon as the primary connection is broken, the system will switch, meaning failover, the routing path to the failover connection to save the dial up time of failover connection since it has been alive.

When the "Seamless" enable checkbox is activated, it can allow the Failover interface to be connected continuously from system booting up. Failover WAN interface just keeps connecting without data traffic.

4G IIoT LoRa Gateway

The purpose is to shorten the switch time during failover process. So, when primary connection is disconnected, failover interface will take over the data transfer mission instantly by only changing routing path to the failover interface. The dialing-up time of failover connection is saved since it has been connected beforehand.

VLAN Tagging

Sometimes, your ISP required a VLAN tag to be inserted into the WAN packets from Gateway for specific services. Please enable VLAN tagging and specify tag in the WAN physical interface. Please be noted that only Ethernet and ADSL physical interfaces support the feature. For the device with 3G/4G WAN only, it is disabled.

4G IIoT LoRa Gateway

Physical Interface Setting

Go to **Basic Network > WAN > Physical Interface** tab.

The Physical Interface allows user to setup the physical WAN interface and to adjust WAN's behavior.

Note: Numbers of available WAN Interfaces can be different for the purchased gateway.

Physical Interface List			
Interface Name	Physical Interface	Operation Mode	Action
WAN-1	Ethernet	Always on	Edit
WAN-2	3G/4G	Always on	Edit
WAN-3	-	Disable	Edit
WAN-4	-	Disable	Edit

When **Edit** button is applied, an **Interface Configuration** screen will appear. WAN-1 interface is used in this example.

Interface Configuration:

Interface Configuration (WAN - 1)	
Item	Setting
Physical Interface	Ethernet
Operation Mode	Always on
VLAN Tagging	<input type="checkbox"/> Enable 2 (1-4095)

Interface Configuration		
Item	Value setting	Description
Physical Interface	1. A Must fill setting 2. WAN-1 is the primary interface and is factory set to Always on.	Select one expected interface from the available interface dropdown list. It can be 3G/4G , or Etherent . Depending on the gateway model, Disable and Failover options will be available only to multiple WAN gateways. WAN-2 ~ WAN-4 interfaces are only available to multiple WAN gateway.s
Operation Mode	A Must fill setting	Define the operation mode of the interface. Select Always on to make this WAN always active. Select Disable to disable this WAN interface. Select Failover to make this WAN a Failover WAN when the primary or the

4G IIoT LoRa Gateway

		<p>secondary WAN link failed. Then select the primary or the existed secondary WAN interface to switch Failover from.</p> <p>(Note: for WAN-1, only Always on option is available.)</p>
VLAN Tagging	Optional setting	<p>Check Enable box to enter tag value provided by your ISP. Otherwise uncheck the box.</p> <p><u>Value Range:</u> 1 ~ 4095.</p> <p>Note: This feature is NOT available for 3G/4G WAN connection.</p>

4G IIoT LoRa Gateway

2.1.2 Internet Setup

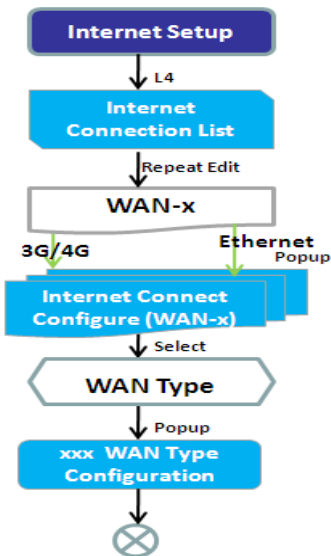

Internet Connection List				
Interface Name	Physical Interface	Operation Mode	WAN Type	Action
WAN-1	Ethernet	Always on	Static IP	Edit
WAN-2	3G/4G	Always on	3G/4G	Edit
WAN-3	-	Disable	-	Edit
WAN-4	-	Disable	-	Edit

Internet Connection Configuration (WAN - 1)	
Item	Setting
WAN Type	Dynamic IP ▼

Dynamic IP WAN Type Configuration	
Item	Setting
Host Name	<input type="text"/> (Optional)
ISP Registered MAC Address	<input type="text"/> (Optional)
Connection Control	Auto-reconnect ▼
MTU Setup	<input type="checkbox"/> Enable
NAT	<input checked="" type="checkbox"/> Enable
IGMP	Disable ▼
WAN IP Alias	<input type="checkbox"/> Enable <input type="text" value="10.0.0.1"/>

After specifying the physical interface for each WAN connection, administrator must configure their connection profile to meet the dial in process of ISP, so that all client hosts in the Intranet of the gateway can access the Internet.

In "Internet Setup" page, there are some configuration windows: "Internet Connection List", "Internet Connection Configuration", "WAN Type Configuration" and related configuration windows for each WAN type. For the Internet setup of each WAN interface, you must specify its WAN type of physical interface first and then its related parameter configuration for that WAN type.

After clicking on the "Edit" button of a physical interface in "Internet Setup List" window, the "Internet Connection Configuration" window will appear to let you specify which kind of WAN type that you will use for that physical interface to make an Internet connection. Based on your chosen WAN type, you can configure necessary parameters in each corresponding configuration window.

4G IIoT LoRa Gateway

Internet Connection List - Ethernet WAN

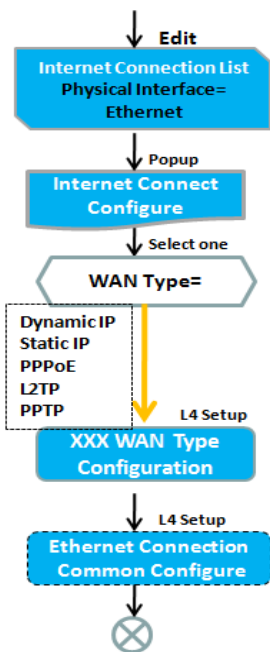

Internet Connection Configuration (WAN - 1)	
Item	Setting
▶ WAN Type	Dynamic IP ▼
Dynamic IP WAN Type Configuration	
Dynamic IP	
Item	Setting
▶ Host Name	(Optional)
▶ ISP Registered MAC Address	<input type="text"/> Clone (Optional)
▶ Connection Control	Auto-reconnect ▼
▶ MTU Setup	<input type="checkbox"/> Enable
▶ NAT	<input checked="" type="checkbox"/> Enable
▶ IGMP	Disable ▼
▶ WAN IP Alias	<input type="checkbox"/> Enable <input type="text" value="10.0.0.1"/>
Network Monitoring Configuration	
Item	Setting
▶ Network Monitoring Configuration	<input checked="" type="checkbox"/> Enable
▶ Checking Method	DNS Query ▼
▶ Loading Check	<input checked="" type="checkbox"/> Enable
▶ Query Interval	<input type="text" value="5"/> (seconds)
▶ Latency Threshold	<input type="text" value="3000"/> (ms)

WAN Type for Ethernet Interface:

Ethernet is the most common WAN and uplink interface for M2M gateways. Usually it is connected with xDSL or cable modem for you to setup the WAN connection. There are various WAN types to connect with ISP.

- **Static IP:** Select this option if ISP provides a fixed IP to you when you subscribe the service. Usually is more expensive but very important for cooperate requirement.
- **Dynamic IP:** The assigned IP address for the WAN by a DHCP server is different every time. It is cheaper and usually for consumer use.
- **PPP over Ethernet:** As known as PPPoE. This WAN type is widely used for ADSL connection. IP is usually different for every dial up.
- **PPTP:** This WAN type is popular in some countries, like Russia.
- **L2TP :** This WAN type is popular in some countries, like Israel.

Configure Ethernet WAN Setting

When **Edit** button is applied, **Internet Connection Configuration** screen will appear. WAN-1 interface is used in this example.

4G IIoT LoRa Gateway

WAN Type = Dynamic IP

Internet Connection Configuration (WAN - 1)	
Item	Setting
▶ WAN Type	Dynamic IP ▼

When you select it, "Dynamic IP WAN Type Configuration" will appear. Items and setting is explained below

Dynamic IP WAN Type Configuration	
Item	Setting
▶ Host Name	<input type="text"/> (Optional)
▶ ISP Registered MAC Address	<input type="text"/> <input type="button" value="Clone"/> (Optional)

Dynamic IP WAN Type Configuration		
Item	Value setting	Description
Host Name	An optional setting	Enter the host name provided by your Service Provider.
ISP Registered MAC Address	An optional setting	Enter the MAC address that you have registered with your service provider. Or Click the Clone button to clone your PC's MAC to this field. Usually this is the PC's MAC address assigned to allow you to connect to Internet.

WAN Type= Static IP

Internet Connection Configuration (WAN - 1)	
Item	Setting
▶ WAN Type	Static IP ▼

When you select it, "Static IP WAN Type Configuration" will appear. Items and setting is explained below

Static IP WAN Type Configuration	
Item	Setting
▶ WAN IP Address	<input type="text"/>
▶ WAN Subnet Mask	255.255.255.0 (/24) ▼
▶ WAN Gateway	<input type="text"/>
▶ Primary DNS	<input type="text"/>
▶ Secondary DNS	<input type="text"/> (Optional)

4G IIoT LoRa Gateway

Static IP WAN Type Configuration		
Item	Value setting	Description
WAN IP Address	A Must filled setting	Enter the WAN IP address given by your Service Provider
WAN Subnet Mask	A Must filled setting	Enter the WAN subnet mask given by your Service Provider
WAN Gateway	A Must filled setting	Enter the WAN gateway IP address given by your Service Provider
Primary DNS	A Must filled setting	Enter the primary WAN DNS IP address given by your Service Provider
Secondary DNS	An optional setting	Enter the secondary WAN DNS IP address given by your Service Provider

WAN Type= PPPoE

Internet Connection Configuration (WAN - 1)

Item	Setting
▶ WAN Type	<input style="width: 100%;" type="text" value="PPPoE"/>

When you select it, "PPPoE WAN Type Configuration" will appear. Items and setting is explained below

PPPoE WAN Type Configuration

Item	Setting
▶ IP Type	<input style="width: 100%;" type="text" value="IPv4"/>
▶ PPPoE Account	<input style="width: 100%;" type="text"/>
▶ PPPoE Password	<input style="width: 100%;" type="text"/>
▶ Primary DNS	<input style="width: 100%;" type="text"/> (Optional)
▶ Secondary DNS	<input style="width: 100%;" type="text"/> (Optional)
▶ Service Name	<input style="width: 100%;" type="text"/> (Optional)
▶ Assigned IP Address	<input style="width: 100%;" type="text"/> (Optional)

PPPoE WAN Type Configuration		
Item	Value setting	Description
PPPoE Account	A Must filled setting	Enter the PPPoE User Name provided by your Service Provider.
PPPoE Password	A Must filled setting	Enter the PPPoE password provided by your Service Provider.
Primary DNS	An optional setting	Enter the IP address of Primary DNS server.
Secondary DNS	An optional setting	Enter the IP address of Secondary DNS server.
Service Name	An optional setting	Enter the service name if your ISP requires it
Assigned IP Address	An optional setting	Enter the IP address assigned by your Service Provider.

4G IIoT LoRa Gateway

WAN Type= PPTP

Internet Connection Configuration (WAN - 1)	
Item	Setting
▶ WAN Type	PPTP ▼

When you select it, "PPTP WAN Type Configuration" will appear. Items and setting is explained below

PPTP WAN Type Configuration	
Item	Setting
▶ IP Mode	Dynamic IP Address ▼
▶ Server IP Address / Name	<input type="text"/>
▶ PPTP Account	<input type="text"/>
▶ PPTP Password	<input type="text"/>
▶ Connection ID	<input type="text"/> (Optional)
▶ MPPE	<input type="checkbox"/> Enable

PPTP WAN Type Configuration		
Item	Value setting	Description
IP Mode	A Must filled setting	Select either Static or Dynamic IP address for PPTP Internet connection. <ul style="list-style-type: none"> ● When Static IP Address is selected, you will need to enter the WAN IP Address, WAN Subnet Mask, and WAN Gateway. <ul style="list-style-type: none"> ■ WAN IP Address (A Must filled setting): Enter the WAN IP address given by your Service Provider. ■ WAN Subnet Mask (A Must filled setting): Enter the WAN subnet mask given by your Service Provider. ■ WAN Gateway (A Must filled setting): Enter the WAN gateway IP address given by your Service Provider. ● When Dynamic IP is selected, there are no above settings required.
Server IP Address/Name	A Must filled setting	Enter the PPTP server name or IP Address.
PPTP Account	A Must filled setting	Enter the PPTP username provided by your Service Provider.
PPTP Password	A Must filled setting	Enter the PPTP connection password provided by your Service Provider.
Connection ID	An optional setting	Enter a name to identify the PPTP connection.
MPPE	An optional setting	Select Enable to enable MPPE (Microsoft Point-to-Point Encryption) security for PPTP connection.

4G IIoT LoRa Gateway

WAN Type= L2TP

Internet Connection Configuration (WAN - 1)	
Item	Setting
▶ WAN Type	L2TP ▼

When you select it, "L2TP WAN Type Configuration" will appear. Items and setting is explained below

L2TP WAN Type Configuration	
Item	Setting
▶ IP Mode	Dynamic IP Address ▼
▶ Server IP Address / Name	<input type="text"/>
▶ L2TP Account	<input type="text"/>
▶ L2TP Password	<input type="text"/>
▶ Service Port	User-defined ▼ <input type="text" value="1702"/>
▶ MPPE	<input type="checkbox"/> Enable

L2TP WAN Type Configuration		
Item	Value setting	Description
IP Mode	A Must filled setting	<p>Select either Static or Dynamic IP address for L2TP Internet connection.</p> <ul style="list-style-type: none"> When Static IP Address is selected, you will need to enter the WAN IP Address, WAN Subnet Mask, and WAN Gateway. <ul style="list-style-type: none"> WAN IP Address (A Must filled setting): Enter the WAN IP address given by your Service Provider. WAN Subnet Mask (A Must filled setting): Enter the WAN subnet mask given by your Service Provider. WAN Gateway (A Must filled setting): Enter the WAN gateway IP address given by your Service Provider. When Dynamic IP is selected, there are no above settings required.
Server IP Address/Name	A Must filled setting	Enter the L2TP server name or IP Address.
L2TP Account	A Must filled setting	Enter the L2TP username provided by your Service Provider.
L2TP Password	A Must filled setting	Enter the L2TP connection password provided by your Service Provider.
Service Port	A Must filled setting	<p>Enter the service port that the Internet service.</p> <p>There are three options can be selected :</p> <ul style="list-style-type: none"> Auto: Port will be automatically assigned. 1701 (For Cisco): Set service port to port 1701 to connect to CISCO server. User-defined: enter a service port provided by your Service Provider.
MPPE	An optional setting	Select Enable to enable MPPE (Microsoft Point-to-Point Encryption) security for PPTP connection.

4G IIoT LoRa Gateway

Ethernet Connection Common Configuration

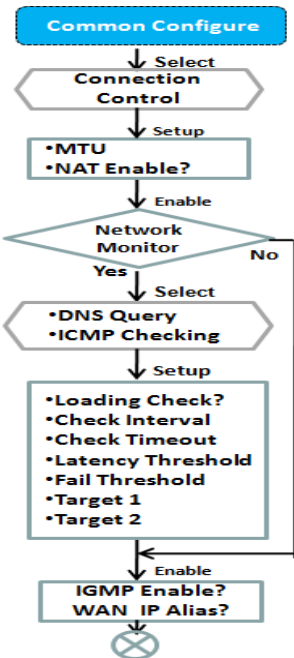

▶ Connection Control	Auto-reconnect ▼
▶ MTU Setup	<input type="checkbox"/> Enable
▶ NAT	<input checked="" type="checkbox"/> Enable
▶ IGMP	Disable ▼
▶ WAN IP Alias	<input type="checkbox"/> Enable 10.0.0.1
Network Monitoring Configuration	
▶ Network Monitoring Configuration	<input checked="" type="checkbox"/> Enable
▶ Checking Method	DNS Query ▼
▶ Loading Check	<input checked="" type="checkbox"/> Enable
▶ Query Interval	5 (seconds)
▶ Latency Threshold	3000 (ms)
▶ Fail Threshold	5 (Times)
▶ Target1	DNS1 ▼
▶ Target2	None ▼

There are some important parameters to be setup no matter which Ethernet WAN type is selected. You should follow up the rule to configure.

Connection Control.

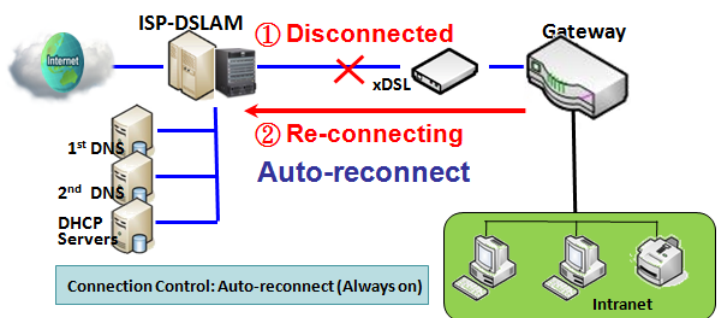

Auto-reconnect: This gateway will establish Internet connection automatically once it has been booted up, and try to reconnect once the connection is down. It's recommended to choose this scheme if for mission critical applications to ensure full-time Internet connection.

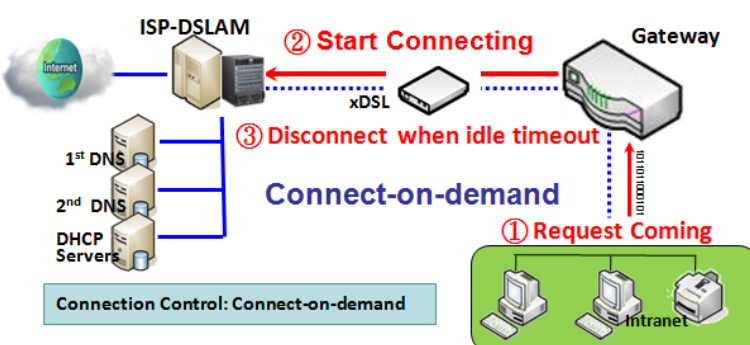

Connect-on-demand: This gateway won't start to establish Internet connection until local data is going to be sent to WAN side. After normal data transferring between LAN and WAN sides, this gateway will disconnect WAN connection if idle time reaches value of Maximum Idle Time.

4G IIoT LoRa Gateway

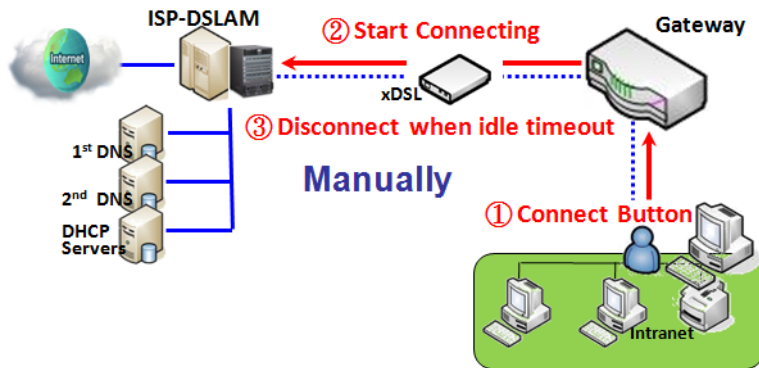

Manually: This gateway won't start to establish WAN connection until you press "Connect" button on web UI. After normal data transferring between LAN and WAN sides, this gateway will disconnect WAN connection if idle time reaches value of Maximum Idle Time.

Please be noted, if the WAN interface serves as the primary one for another WAN interface in Failover role, the Connection Control parameter will not be available to you to configure as the system must set it to "Auto-reconnect (Always on)".

Network Monitoring

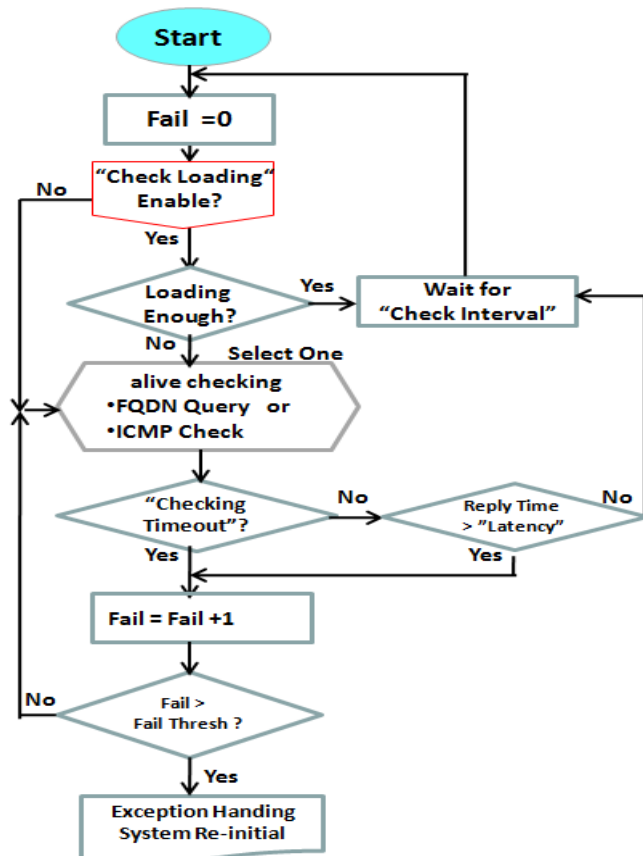

It is necessary to monitor connection status continuous. To do it, "ICMP Check" and "FQDN Query" are used to check. When there is traffic of connection, checking packet will waste bandwidth. Response time of replied packets may also increase. To avoid "Network Monitoring" work abnormally, enabling "Checking Loading" option will stop connection check when there is traffic. It will wait for another "Check Interval" and then check loading again.

When you do "Network Monitoring", if reply time longer than "Latency" or even no response longer than "Checking Timeout", "Fail" count will be increased. If it is continuous and "Fail" count is more than "Fail Threshold", gateway will do exception handling process and re-initial this connection again. Otherwise, network monitoring process will be start again.

4G IIoT LoRa Gateway

Set up “Ethernet Common Configuration”

Ethernet WAN Common Configuration		
Item	Value setting	Description
Connection Control	A Must filled setting	<p>There are three connection modes.</p> <ul style="list-style-type: none"> • Auto-reconnect enables the router to always keep the Internet connection on. • Connect-on-demand enables the router to automatically re-establish Internet connection as soon as user attempts to access the Internet. Internet connection will be disconnected when it has been inactive for a specified idle time. • Connect Manually allows user to connect to Internet manually. Internet connection will be inactive after it has been inactive for specified idle time.
Maximum Idle Time	<ol style="list-style-type: none"> 1. An Optional setting 2. By default 600 seconds is filled-in 	<p>Specify the maximum Idle time setting to disconnect the internet connection when the connection idle timed out.</p> <p>Value Range: 300 ~ 86400.</p> <p>Note: This field is available only when Connect-on-demand or Connect Manually is selected as the connection control scheme.</p>
MTU Setup	<ol style="list-style-type: none"> 1. An Optional setting 2. Uncheck by default 	<p>Check the Enable box to enable the MTU (Maximum Transmission Unit) limit, and specify the MTU for the 3G/4G connection.</p> <p>MTU refers to Maximum Transmission Unit. It specifies the largest packet size permitted for Internet transmission.</p> <p>Value Range: 1200 ~ 1500.</p>
MTU Setup	<ol style="list-style-type: none"> 1. A Must filled setting 2. Auto (value zero) is set by default 3. Manual set range 1200~1500 	<p>MTU refers to Maximum Transmission Unit. It specifies the largest packet size permitted for Internet transmission.</p> <p>When set to Auto (value '0'), the router selects the best MTU for best Internet connection performance.</p>
NAT	<ol style="list-style-type: none"> 1. An optional setting 2. NAT is enabled by default 	<p>Enable NAT to apply NAT on the WAN connection. Uncheck the box to disable NAT function.</p>
IGMP	<ol style="list-style-type: none"> 1. A Must filled setting 2. Disable is set by default 	<p>Enable IGMP (Internet Group Management Protocol) would enable the router to listen to IGMP packets to discover which interfaces are connected to which device. The router uses the interface information generated by IGMP to reduce bandwidth consumption in a multi-access network environment to avoid flooding the entire network.</p>
WAN IP Alias	<ol style="list-style-type: none"> 1. An optional setting 2. Uncheck by default 	<p>Enable WAN IP Alias then enter the IP address provided by your service provider.</p> <p>WAN IP Alias is used by the device router and is treated as a second set of WAN IP to provide dual WAN IP address to your LAN network.</p>

4G IIoT LoRa Gateway

Network Monitoring Configuration	
Item	Setting
▶ Network Monitoring Configuration	<input checked="" type="checkbox"/> Enable
▶ Checking Method	DNS Query ▼
▶ Loading Check	<input checked="" type="checkbox"/> Enable
▶ Query Interval	5 (seconds)
▶ Latency Threshold	3000 (ms)
▶ Fail Threshold	5 (Times)
▶ Target1	DNS1 ▼
▶ Target2	None ▼

Network Monitoring Configuration		
Item	Value setting	Description
Network Monitoring Configuration	1. An optional setting 2. Box is checked by default	Check the Enable box to activate the network monitoring function.
Checking Method	1. An Optional setting 2. DNS Query is set by default	Choose either DNS Query or ICMP Checking to detect WAN link. With DNS Query , the system checks the connection by sending DNS Query packets to the destination specified in Target 1 and Target 2. With ICMP Checking , the system will check connection by sending ICMP request packets to the destination specified in Target 1 and Target 2.
Loading Check	1. An optional setting 2. Box is checked by default	Check the Enable box to activate the loading check function. Enable Loading Check allows the gateway to ignore unreturned DNS queries or ICMP requests when WAN bandwidth is fully occupied. This is to prevent false link-down status.
Query Interval	1. An Optional setting 2. 5 seconds is selected by default.	Specify a time interval as the DNS Query Interval . Query Interval defines the transmitting interval between two DNS Query or ICMP checking packets. With DNS Query , the system checks the connection by sending DNS Query packets to the destination specified in Target 1 and Target 2. Value Range: 2 ~ 14400.
Check Interval	1. An Optional setting 2. 5 seconds is selected by default.	Specify a time interval as the ICMP Checking Interval . Query Interval defines the transmitting interval between two DNS Query or ICMP checking packets. With ICMP Checking , the system will check connection by sending ICMP request packets to the destination specified in Target 1 and Target 2. Value Range: 2 ~ 14400.
Latency Threshold	1. An Optional setting 2. 3000 ms is set by default	Enter a number of detecting disconnection times to be the threshold before disconnection is acknowledged. Latency Threshold defines the tolerance threshold of responding time. Value Range: 2000 ~ 3000 seconds.
Fail Threshold	1. An Optional setting 2. 5 times is set by default	Enter a number of detecting disconnection times to be the threshold before disconnection is acknowledged. Fail Threshold specifies the detected disconnection before the router recognize the WAN link down status.

4G IIoT LoRa Gateway

		<u>Value Range:</u> 1 ~ 10 times.
Target 1	1. An Optional filled setting 2. DNS1 is selected by default	Target1 specifies the first target of sending DNS query/ICMP request. DNS1: set the primary DNS to be the target. DNS2: set the secondary DNS to be the target. Gateway: set the Current gateway to be the target. Other Host: enter an IP address to be the target.
Target 2	1. An Optional filled setting 2. None is selected by default	Target1 specifies the second target of sending DNS query/ICMP request. None: no second target is required. DNS1: set the primary DNS to be the target. DNS2: set the secondary DNS to be the target. Gateway: set the Current gateway to be the target. Other Host: enter an IP address to be the target.
Save	N/A	Click Save to save the settings.
Undo	N/A	Click Undo to cancel the settings.

4G IIoT LoRa Gateway

Internet Connection – 3G/4G WAN

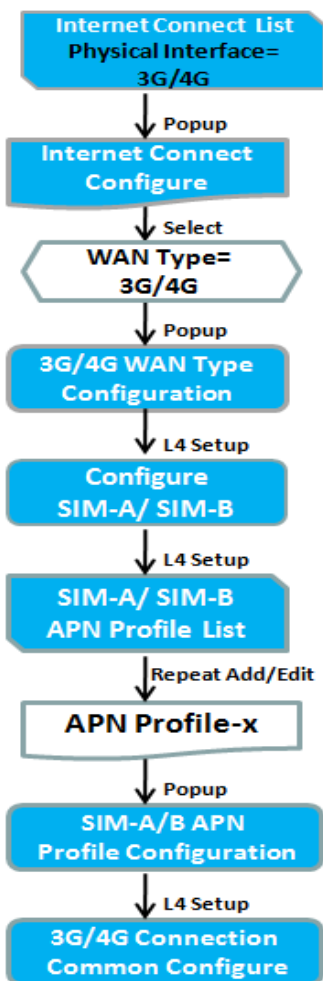

Internet Connection Configuration (WAN - 2)	
Item	Setting
▶ WAN Type	3G/4G ▼
3G/4G WAN Type Configuration	
Item	Setting
▶ Preferred SIM Card	SIM-A First ▼ Failback: <input type="checkbox"/> Enable
▶ Auto Flight Mode	<input type="checkbox"/> Enable
▶ SIM Switch Policy	Policy Setting
Connection with SIM-A Card	
Connection with SIM-B Card	
3G/4G Connection Common Configuration	
Item	Setting
▶ Connection Control	Auto-reconnect ▼
▶ Time Schedule	(0) Always ▼
▶ MTU Setup	<input type="checkbox"/> Enable

Preferred SIM Card – Dual SIM Fail Over

For 3G/4G embedded device, one embedded cellular module can create only one WAN interface. This device has featured by using dual SIM cards for one module with special fail-over mechanism. It is called Dual SIM Failover. This feature is useful for ISP switch over when location is changed. Within “Dual SIM Failover”, there are various usage scenarios, including “SIM-A First”, “SIM-B First” with “Failback” enabled or not, and “SIM-A Only and “SIM-B Only”.

4G IIoT LoRa Gateway

SIM-A/SIM-B only: When “SIM-A Only” or “SIM-B Only” is used, the specified SIM slot card is the only one to be used for negotiation parameters between gateway device and cellular ISP.

SIM-A / SIM-B first without enable Failback

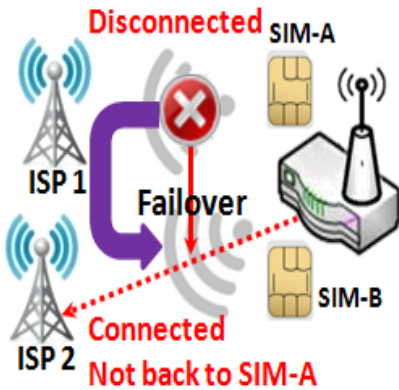

By default, “SIM-A First” scenario is used to connect to cellular ISP for data transfer. In the case of “SIM-A First” or “SIM-B First” scenario, the gateway will try to connect to the Internet by using SIM-A or SIM-B card first. And when the connection is broken, the gateway will switch to use the other SIM card for an alternate automatically and **will not switch back** to use original SIM card except current SIM connection is also broken. That is, SIM-A and SIM-B are used iteratively, but either one will keep being used for data transfer when current connection is still alive.

SIM-A / SIM-B first with Failback enable

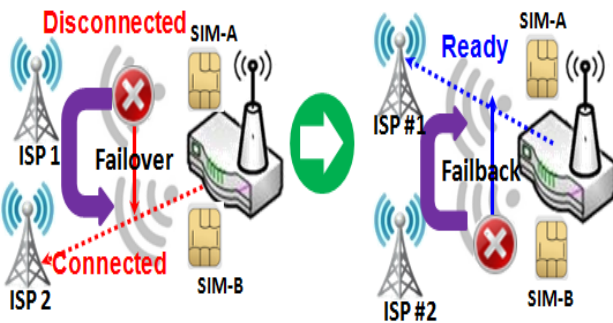

With Failback option enabled, “SIM-A First” scenario is used to connect when the connection is broken, gateway system will switch to use SIM-B. And when SIM-A connection is recovered, it will switch back to use original SIM-A card

4G IIoT LoRa Gateway

Configure 3G/4G WAN Setting

When **Edit** button is applied, **Internet Connection Configuration**, and **3G/4G WAN Configuration** screens will appear.

Internet Connection Configuration (WAN - 2)	
Item	Setting
▶ WAN Type	3G/4G ▼

3G/4G WAN Type Configuration	
Item	Setting
▶ Preferred SIM Card	SIM-A First ▼ Failback : <input type="checkbox"/> Enable
▶ Auto Flight Mode	<input type="checkbox"/> Enable
▶ SIM Switch Policy	Policy Setting

3G/4G Connection Configuration		
Item	Value setting	Description
WAN Type	1. A Must filled setting 2. 3G/4G is set by default.	From the dropdown box, select Internet connection method for 3G/4G WAN Connection. Only 3G/4G is available.
Preferred SIM Card	1. A Must filled setting 2. By default SIM-A First is selected 3. Failback is unchecked by default	Choose which SIM card you want to use for the connection. When SIM-A First or SIM-B First is selected, it means the connection is built first by using SIM A/SIM B. And if the connection is failed, it will change to the other SIM card and try to dial again, until the connection is up. When SIM-A only or SIM-B only is selected, it will try to dial up only using the SIM card you selected. When Failback is checked, it means if the connection is dialed-up not using the main SIM you selected, it will failback to the main SIM and try to establish the connection periodically. Note_1: For the product with single SIM design, only SIM-A Only option is available. Note_2: Failback is available only when SIM-A First or SIM-B First is selected.
Auto Flight Mode	The box is unchecked by default	Check the Enable box to activate the function. By default, if you disabled the Auto Flight Mode , the cellular module will always occupy a physical channel with cellular tower. It can get data connection instantly, and receive managing SMS all the time on required. If you enabled the Auto Flight Mode , the gateway will pop up a message " <i>Flight mode will cause cellular function to be malfunctioned when the data session is offline.</i> "; and it will make the cellular module into flight mode and disconnected with cellular tower phycially. In, addition, whenever the cellular module is going to be used for data connection to backup the failed primary connection, the cellular module will be active to connect with cellular tower and get the data connection for use, It takes few more seconds.

4G IIoT LoRa Gateway

		Note: Keep it unchecked unless your cellular ISP asked the connected gateway to enable the Auto Flight Mode.
SIM Switch Policy	NA	Click the Policy Setting button to define the SIM Switch policy or browse the current policy settings.

Policy Setting	
Item	Setting
▶ Failed connection	<input type="text" value="0"/> (1-10) times
▶ RSSI Monitor	<input type="checkbox"/> Enable Threshold: - <input type="text" value="0"/> (-90~-113 dBm)
▶ Network Service	<input type="checkbox"/> Enable Loss LTE signal: <input type="text" value="0"/> (1~30 minutes)
▶ Roaming Service	<input type="checkbox"/> Enable Timeout: <input type="text" value="0"/> (1~30 minutes)

Configure SIM-A / SIM-B Card

Here you can set configurations for the cellular connection according to your situation or requirement.

Connection with SIM-A Card	
Item	Setting
▶ Network Type	<input type="text" value="Auto"/> ▼
▶ Dial-Up Profile	<input type="text" value="Manual-configuration"/> ▼
▶ APN	<input type="text"/>
▶ PIN Code	<input type="text"/> (Optional)
▶ Dial Number	<input type="text"/> (Optional)
▶ Account	<input type="text"/> (Optional)
▶ Password	<input type="text"/> (Optional)
▶ Authentication	<input type="text" value="Auto"/> ▼
▶ IP Mode	<input type="text" value="Dynamic IP"/> ▼
▶ Primary DNS	<input type="text"/> (Optional)
▶ Secondary DNS	<input type="text"/> (Optional)
▶ Roaming	<input type="checkbox"/> Enable

Note_1: Configurations of SIM-B Card follows the same rule of Configurations of SIM-A Card, here we list SIM-A as the example.

Note_2: Both **Connection with SIM-A Card** and **Connection with SIM-B Card** will pop up only when the **SIM-A First** or **SIM-B First** is selected, otherwise it only pops out one of them.

4G IIoT LoRa Gateway

Connection with SIM-A/-B Card		
Item	Value setting	Description
Network Type	<ol style="list-style-type: none"> 1. A Must filled setting 2. By default Auto is selected 	<p>Select Auto to register a network automatically, regardless of the network type.</p> <p>Select 2G Only to register the 2G network only.</p> <p>Select 2G Prefer to register the 2G network first if it is available.</p> <p>Select 3G only to register the 3G network only.</p> <p>Select 3G Prefer to register the 3G network first if it is available.</p> <p>Select LTE only to register the LTE network only.</p> <p>Note: Options may be different due to the specification of the module.</p>
Dial-Up Profile	<ol style="list-style-type: none"> 1. A Must filled setting 2. By default Manual-configuration is selected 	<p>Specify the type of dial-up profile for your 3G/4G network. It can be Manual-configuration, APN Profile List, or Auto-detection.</p> <p>Select Manual-configuration to set APN (Access Point Name), Dial Number, Account, and Password to what your carrier provides.</p> <p>Select APN Profile List to set more than one profile to dial up in turn, until the connection is established. It will pop up a new filed, please go to Basic Network > WAN & Uplink > Internet Setup > SIM-A APN Profile List for details.</p> <p>Select Auto-detection to automatically bring out all configurations needed while dialing-up, by comparing the IMSI of the SIM card to the record listed in the manufacturer's database.</p> <p>Note_1: You are highly recommended to select the Manual or APN Profile List to specify the network for your subscription. Your ISP always provides such network settings for the subscribers.</p> <p>Note_2: If you select Auto-detection, it is likely to connect to improper network, or failed to find a valid APN for your ISP.</p>
APN	<ol style="list-style-type: none"> 1. A Must filled setting 2. String format : any text 	<p>Enter the APN you want to use to establish the connection.</p> <p>This is a must-filled setting if you selected Manual-configuration as dial-up profile scheme.</p>
IP Type	<ol style="list-style-type: none"> 1. A Must filled setting 2. By default IPv4 is selected 	<p>Specify the IP type of the network service provided by your 3G/4G network. It can be IPv4, IPv6, or IPv4/6.</p>
PIN code	<ol style="list-style-type: none"> 1. An Optional setting 2. String format : interger 	<p>Enter the PIN (Personal Identification Number) code if it needs to unlock your SIM card.</p>
Dial Number, Account, Password	<ol style="list-style-type: none"> 1. An Optional setting 2. String format : any text 	<p>Enter the optional Dial Number, Account, and Password settings if your ISP provided such settings to you.</p> <p>Note: These settings are only displayed when Manual-configuration is selected.</p>
Authentication	<ol style="list-style-type: none"> 1. A Must filled setting 2. By default Auto is selected 	<p>Select PAP (Password Authentication Protocol) and use such protocol to be authenticated with the carrier's server.</p> <p>Select CHAP (Challenge Handshake Authentication Protocol) and use such protocol to be authenticated with the carrier's server.</p> <p>When Auto is selected, it means it will authenticate with the server either PAP or CHAP.</p>
IP Mode	<ol style="list-style-type: none"> 1. A Must filled setting 2. By default Dynamic IP is selected 	<p>When Dynamic IP is selected, it means it will get all IP configurations from the carrier's server and set to the device directly.</p> <p>If you have specific application provided by the carrier, and want to set IP</p>

4G IIoT LoRa Gateway

		configurations on your own, you can switch to Static IP mode and fill in all parameters that required, such as IP address, subnet mask and gateway. Note: IP Subnet Mask is a must filled setting, and make sure you have the right configuration. Otherwise, the connection may get issues.
Primary DNS	1. An Optional setting 2. String format : IP address (IPv4 type)	Enter the IP address to change the primary DNS (Domain Name Server) setting. If it is not filled-in, the server address is given by the carrier while dialing-up.
Secondary DNS	1. An Optional setting 2. String format : IP address (IPv4 type)	Enter the IP address to change the secondary DNS (Domain Name Server) setting. If it is not filled-in, the server address is given by the carrier while dialing-up.
Roaming	The box is unchecked by default	Check the box to establish the connection even the registration status is roaming, not in home network. Note: It may cost additional charges if the connection is under roaming.

Create/Edit SIM-A / SIM-B APN Profile List

You can add a new APN profile for the connection, or modify the content of the APN profile you added. It is available only when you select **Dial-Up Profile** as **APN Profile List**.

SIM-A APN Profile List Add Delete									
ID	Profile Name	APN	IP Type	Account	Password	Authentication	Priority	Enable	Actions

List all the APN profile you created, easily for you to check and modify. It is available only when you select **Dial-Up Profile** as **APN Profile List**.

When **Add** button is applied, an **APN Profile Configuration** screen will appear.

SIM-A APN Profile Configuration	
Item	Setting
▶ Profile Name	<input type="text" value="Profile-1"/>
▶ APN	<input type="text"/>
▶ IP Type	<input type="text" value="IPv4"/> ▼
▶ Account	<input type="text"/> (Optional)
▶ Password	<input type="text"/> (Optional)
▶ Authentication	<input type="text" value="Auto"/> ▼
▶ Priority	<input type="text"/>
▶ Profile	<input type="checkbox"/> Enable

SIM-A/-B APN Profile Configuration		
Item	Value setting	Description
Profile Name	1. By default Profile-x is	Enter the profile name you want to describe for this profile.

4G IIoT LoRa Gateway

	listed 2. String format : any text	
APN	String format : any text	Enter the APN you want to use to establish the connection.
IP Type	1. A Must filled setting 2. By default IPv4 is selected	Specify the IP type of the network service provided by your 3G/4G network. It can be IPv4 , IPv6 , or IPv4/6 .
Account	String format : any text	Enter the Account you want to use for the authentication. Value Range: 0 ~ 53 characters.
Password	String format : any text	Enter the Password you want to use for the authentication.
Authentication	1. A Must filled setting 2. By default Auto is selected	Select the Authentication method for the 3G/4G connection. It can be Auto , PAP , CHAP , or None .
Priority	1. A Must filled setting 2. String format : integer	Enter the value for the dialing-up order. The valid value is from 1 to 16. It will start to dial up with the profile that assigned with the smallest number. Value Range: 1 ~ 16.
Profile	The box is checked by default	Check the box to enable this profile. Uncheck the box to disable this profile in dialing-up action.
Save	N/A	Click the Save button to save the configuration.
Undo	N/A	Click the X button to restore what you just configured back to the previous setting.

Setup 3G/4G Connection Common Configuration

Here you can change common configurations for 3G/4G WAN.

3G/4G Connection Common Configuration	
Item	Setting
▶ Connection Control	Auto-reconnect ▼
▶ Time Schedule	(0) Always ▼
▶ MTU Setup	<input type="checkbox"/> Enable
▶ IP Passthrough (Cellular Bridge)	<input type="checkbox"/> Enable Fixed MAC : <input type="text"/>
▶ NAT	<input checked="" type="checkbox"/> Enable
▶ IGMP	Disable ▼
▶ WAN IP Alias	<input type="checkbox"/> Enable <input type="text" value="10.0.0.1"/>

3G/4G Connection Common Configuration		
Item	Value setting	Description
Connection Control	By default Auto-reconnect is selected	When Auto-reconnect is selected, it means it will try to keep the Internet connection on all the time whenever the physical link is connected. When Connect-on-demand is selected, it means the Internet connection will be established only when detecting data traffic. When Connect Manually is selected, it means you need to click the Connect button to dial up the connection manually. Please go to Status >

4G IIoT LoRa Gateway

		<p>Basic Network > WAN & Uplink tab for details.</p> <p>Note: If the WAN interface serves as the primary one for another WAN interface in Failover role(and vice versa), the Connection Control parameter will not be available on both WANs as the system must set it to "Auto-reconnect"</p>
Maximum Idle Time	<p>1. An Optional setting 2. By default 600 seconds is filled-in</p>	<p>Specify the maximum Idle time setting to disconnect the internet connection when the connection idle timed out. Value Range: 300 ~ 86400. Note: This field is available only when Connect-on-demand or Connect Manually is selected as the connection control scheme.</p>
Time Schedule	<p>1. A Must filled setting 2. By default (0) Always is selected</p>	<p>When (0) Always is selected, it means this WAN is under operation all the time. Once you have set other schedule rules, there will be other options to select. Please go to Object Definition > Scheduling for details.</p>
MTU Setup	<p>1. An Optional setting 2. Uncheck by default</p>	<p>Check the Enable box to enable the MTU (Maximum Transmission Unit) limit, and specify the MTU for the 3G/4G connection. MTU refers to Maximum Transmission Unit. It specifies the largest packet size permitted for Internet transmission. Value Range: 1200 ~ 1500.</p>
IP Pass-through (Cellular Bridge)	<p>1. The box is unchecked by default 2. String format for Fixed MAC: MAC address, e.g. 00:50:18:aa:bb:cc</p>	<p>When Enable box is checked, it means the device will directly assign the WAN IP to the first connected local LAN client. However, when an optional Fixed MAC is filled-in a non-zero value, it means only the client with this MAC address can get the WAN IP address. Note: When the IP Pass-through is on, NAT and WAN IP Alias will be unavailable until the function is disabled again.</p>
NAT	Check by default	Uncheck the box to disable NAT (Network Address Translation) function.
IGMP	By default Disable is selected	Select Auto to enable IGMP function. Check the Enable box to enable IGMP Proxy .
WAN IP Alias	<p>1. Unchecked by default 2. String format: IP address (IPv4 type)</p>	Check the box to enable WAN IP Alias , and fill in the IP address you want to assign.

Network Monitoring Configuration	
Item	Setting
▶ Network Monitoring Configuration	<input checked="" type="checkbox"/> Enable
▶ Checking Method	DNS Query ▼
▶ Loading Check	<input checked="" type="checkbox"/> Enable
▶ Query Interval	5 (seconds)
▶ Latency Threshold	3000 (ms)
▶ Fail Threshold	5 (Times)
▶ Target1	DNS1 ▼
▶ Target2	None ▼

4G IIoT LoRa Gateway

Network Monitoring Configuration		
Item	Value setting	Description
Network Monitoring Configuration	1. An optional setting 2. Box is checked by default	Check the Enable box to activate the network monitoring function.
Checking Method	1. An Optional setting 2. DNS Query is set by default	Choose either DNS Query or ICMP Checking to detect WAN link. With DNS Query , the system checks the connection by sending DNS Query packets to the destination specified in Target 1 and Target 2. With ICMP Checking , the system will check connection by sending ICMP request packets to the destination specified in Target 1 and Target 2.
Loading Check	1. An optional setting 2. Box is checked by default	Check the Enable box to activate the loading check function. Enable Loading Check allows the gateway to ignore unreturned DNS queries or ICMP requests when WAN bandwidth is fully occupied. This is to prevent false link-down status.
Query Interval	1. An Optional setting 2. 5 seconds is selected by default.	Specify a time interval as the DNS Query Interval . Query Interval defines the transmitting interval between two DNS Query or ICMP checking packets. With DNS Query , the system checks the connection by sending DNS Query packets to the destination specified in Target 1 and Target 2. Value Range: 2 ~ 14400.
Check Interval	1. An Optional setting 2. 5 seconds is selected by default.	Specify a time interval as the ICMP Checking Interval . Query Interval defines the transmitting interval between two DNS Query or ICMP checking packets. With ICMP Checking , the system will check connection by sending ICMP request packets to the destination specified in Target 1 and Target 2. Value Range: 2 ~ 14400.
Latency Threshold	1. An Optional setting 2. 3000 ms is set by default	Enter a number of detecting disconnection times to be the threshold before disconnection is acknowledged. Latency Threshold defines the tolerance threshold of responding time. Value Range: 2000 ~ 3000 seconds.
Fail Threshold	1. An Optional setting 2. 5 times is set by default	Enter a number of detecting disconnection times to be the threshold before disconnection is acknowledged. Fail Threshold specifies the detected disconnection before the router recognize the WAN link down status. Value Range: 1 ~ 10 times.
Target 1	1. An Optional filled setting 2. DNS1 is selected by default	Target1 specifies the first target of sending DNS query/ICMP request. DNS1: set the primary DNS to be the target. DNS2: set the secondary DNS to be the target. Gateway: set the Current gateway to be the target. Other Host: enter an IP address to be the target.
Target 2	1. An Optional filled setting 2. None is selected by default	Target1 specifies the second target of sending DNS query/ICMP request. None: no second target is required. DNS1: set the primary DNS to be the target. DNS2: set the secondary DNS to be the target. Gateway: set the Current gateway to be the target. Other Host: enter an IP address to be the target.
Save	N/A	Click Save to save the settings.
Undo	N/A	Click Undo to cancel the settings.

4G IIoT LoRa Gateway

2.1.3 Load Balance

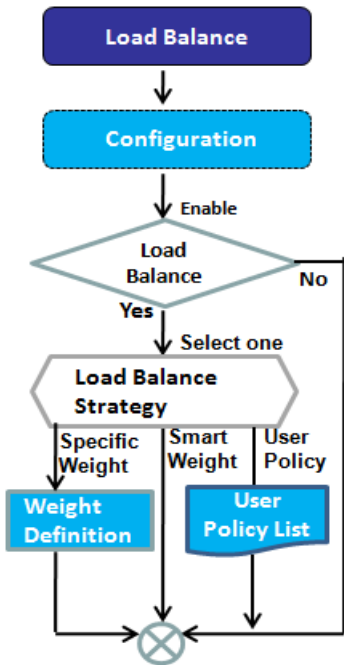

Item	Setting
Load Balance	<input checked="" type="checkbox"/> Enable
Load Balance Strategy	By Specific Weight ▼
	By Smart Weight
	By Specific Weight
	By User Policy

WAN ID	Weight	Action
WAN - 1	86 %	Edit
WAN - 2	13 %	Edit

ID	Source IP Address	Destination IP Address	Destination Port	WAN Interface	Enable	Actions
----	-------------------	------------------------	------------------	---------------	--------	---------

When there are multiple WAN interfaces, and when the bandwidth of one WAN connection is not enough for the traffic loads from the Intranet to the Internet, the WAN load balance function can be considered to enlarge the total WAN bandwidth.

Load Balance Strategy

There are three optional strategies for load balance: **“By Smart Weight”**, **“By Specific Weight”**, and **“By User Policy”**. Administrator can select strategy according to application requirement and environment status. The strategies are explained as below.

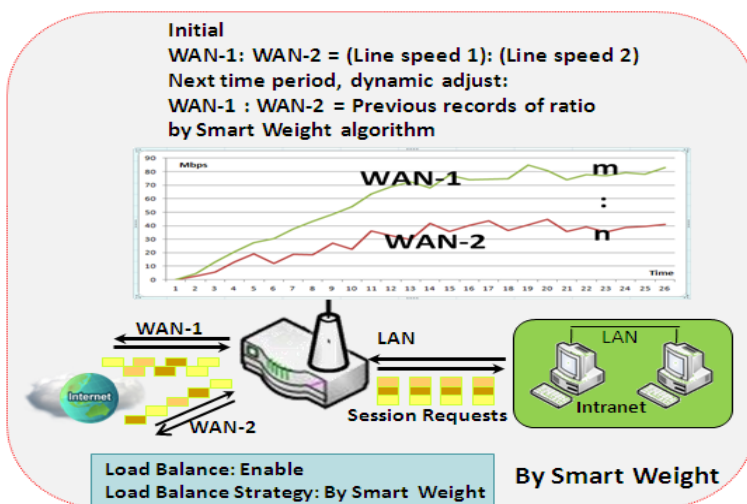

By Smart Weight

If based on "By Smart Weight" strategy, gateway will take the line speed settings of all WAN interfaces specified in "Physical Interface" configuration page as default ratio for data transfer. Based on the ratio of packet bytes via these WAN interfaces in past period (maybe 5 minutes), system decides how many sessions will be transferred via each WAN interface for next period. Administrator may take it as a fast approach to maximize the bandwidth utilization of multiple WAN interfaces in gateway

4G IIoT LoRa Gateway

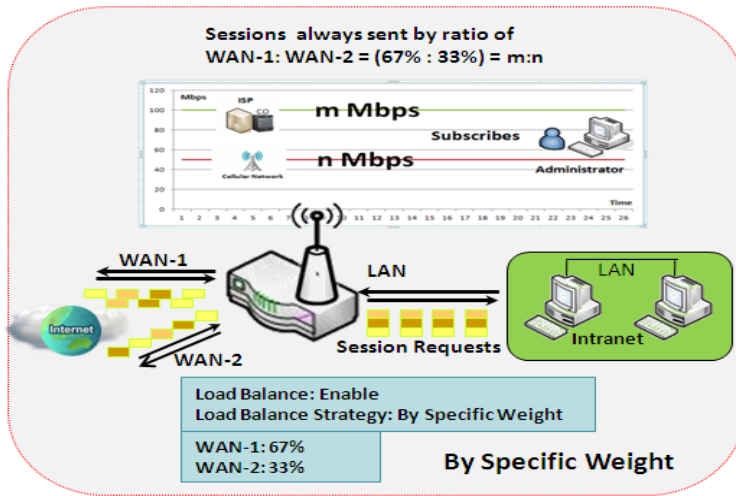

By Specific Weight

When you select "By Specific Weight", you need to set up ratio of WAN-1/WAN-2 to decide sessions sent ratio. Total ratio should be 100%. Ratio is usually defined based on practical WAN speed of environment. Gateway's traffic control process will operate routing adequately based on the dedicated weights ratio on all WAN interfaces.

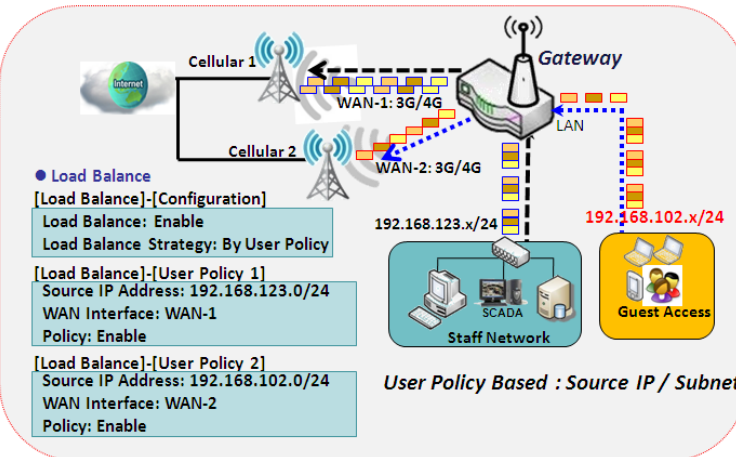

By User Policy

If "By User Policy" load balance strategy is selected, it can allow you to mapping Source IP, Destination IP, or Destination Port to assigned WAN interface. This IP address is not only a single IP but also a subnet or IP range. Destination port can be a single port or port range. You can select one target for one mapping to setup IP address and leave others just left as "any"/ "All". Besides this, you can also set protocol as TCP, UDP or both.

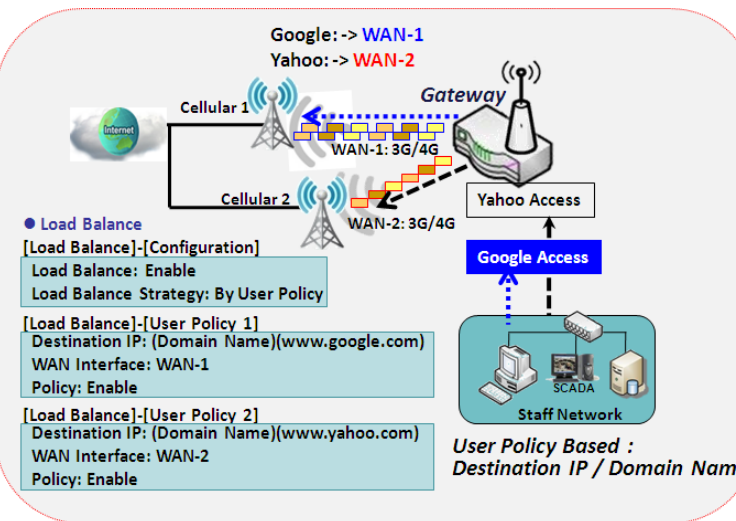

Diagrams shown on left side are examples user policy. The first diagram illustrates example for mapping various source IP subnets to different WAN interface. All packets from different subnet will be routed to the assigned WAN interface. Administrator can manage and balance the loading among available WAN interfaces accordingly.

The second diagram illustrates another example for routing packets with designated destination IP or domain name to a certain WAN interface. If packets no belong to user policy rule, the gateway just routes those packets based on smart weight algorithm.

4G IIoT LoRa Gateway

Load Balance Setting

Go to **Basic Network > WAN & Uplink > Load Balance** Tab.

The **Load Balance** function is used to manage balance bandwidth usage among multiple WAN connections. When you choose "By Smart Weight" strategy, system will operate load balance function automatically based on the embedded Smart Weight algorithm. However, when you choose "By Specific Weight" strategy, the further "Weight Definition" configuration window will let you define the ratio of transferred sessions between all WAN interfaces for data transfer. At last, when you choose "By User Policy" strategy, the further "User Policy List" shows all defined user policy entries, and the "User Policy Configuration" window will let you create and define one user policy for routing dedicated packet flow via one WAN interface.

Enable/Select Load Balance Strategy

Configuration	
Item	Setting
▶ Load Balance	<input type="checkbox"/> Enable
▶ Load Balance Strategy	By Specific Weight ▼

Configuration		
Item	Value setting	Description
Load Balance	Unchecked by default	Check the Enable box to activate Load Balance function.
Load Balance Strategy	1. A Must filled setting 2. By Smart Weight is selected by default.	There are up to three load balance strategies. Select the preferred one. By Smart Weight: System will operate load balance function automatically based on the embedded Smart Weight algorithm. By Specific Weight: System will adjust the ratio of transferred sessions among all WANs based on the specified weights for each WAN. By User Policy: System will route traffics through available WAN interface based on user defined rules. Note: The number of available strategies depends on the model you purchased.
Save	NA	Click the Save button to save the configuration
Undo	NA	Click the Undo button to restore what you just configured back to the previous setting.

When **By Specific Weight** is selected, user needs to adjust the percentage of WAN loading. System will give a value according to the bandwidth ratio of each WAN at first time and keep the value after clicking **Save** button.

4G IIoT LoRa Gateway

Weight Definition		
WAN ID	Weight	Action
WAN - 1	86 %	<input type="button" value="Edit"/>
WAN - 2	13 %	<input type="button" value="Edit"/>

Weight Definition		
Item	Value setting	Description
WAN ID	NA	The Identifier for each available WAN interface..
Weight	1. A Must filled setting 2. Set with bandwidth ratio of each WAN by default.	Enter the weight ratio for each WAN interface. Initially, the bandwidth ratio of each WAN is set by default. Value Range: 1 ~ 99. Note: The sum of all weights can't be greater than 100%.
Save	NA	Click the Save button to save the configuration
Undo	NA	Click the Undo button to restore what you just configured back to the previous setting.

When **By User Policy** is selected, a **User Policy List** screen will appear. With properly configured your policy rules, system will route traffics through available WAN interface based on user defined rules

Create User Policy

User Policy List <input type="button" value="Add"/> <input type="button" value="Delete"/>						
ID	Source IP Address	Destination IP Address	Destination Port	WAN Interface	Enable	Actions

When **Add** button is applied, **User Policy Configuration** screen will appear.

User Policy Configuration	
Item	Setting
▶ Source IP Address	Any ▼
▶ Destination IP Address	Any ▼
▶ Destination Port	All ▼
▶ Protocol	Both ▼
▶ WAN Interface	WAN - 1 ▼
▶ Policy	<input type="checkbox"/> Enable

User Policy Configuration		
Item	Value setting	Description
Source IP Address	1. A Must filled setting 2. Any is selected by default.	There are four options can be selected : Any: No specific Source IP is provided. The traffic may come from any source Subnet: Specify the Subnet for the traffics come from the subnet. Input format

4G IIoT LoRa Gateway

		<p>is : xxx.xxx.xxx.xxx/xx e.g. 192.168.123.0/24.</p> <p>IP Range: Specify the IP Range for the traffics come from the IPs</p> <p>Single IP: Specify a unique IP Address for the traffics come from the IP. Input format is : xxx.xxx.xxx.xxx e.g. 192.168.123.101.</p>
Destination IP Address	<ol style="list-style-type: none"> 1. A Must filled setting 2. Any is selected by default. 	<p>There are five options can be selected :</p> <p>Any: No specific destination IP is provided. The traffic may come to any destination.</p> <p>Subnet: Specify the Subnet for the traffics come to the subnet. Input format is : xxx.xxx.xxx.xxx/xx e.g. 192.168.123.0/24.</p> <p>IP Range: Specify the IP Range for the traffics come to the IPs</p> <p>Single IP: Specify a unique IP Address for the traffics come to the IP. Input format is : xxx.xxx.xxx.xxx e.g. 192.168.123.101.</p> <p>Domain Name: Specify the domain name for the traffics come to the domain</p>
Destination Port	<ol style="list-style-type: none"> 1. A Must filled setting 2. All is selected by default. 	<p>There are four options can be selected :</p> <p>All: No specific destination port is provided.</p> <p>Port Range: Specify the Destination Port Range for the traffics</p> <p>Single Port: Specify a unique destination Port for the traffics</p> <p>Well-known Applications: Select the service port of well-known application defined in dropdown list.</p>
Protocol	<ol style="list-style-type: none"> 1. A Must filled setting 2. Both is selected by default. 	<p>There are three options can be selected. They are Both, TCP, and UDP.</p>
WAN Interface	<ol style="list-style-type: none"> 1. A Must filled setting 2. WAN-1 is selected by default. 	<p>User can select the interface that traffic should go.</p> <p>Note that the WAN interface dropdown list will only show the available WAN interfaces.</p>
Policy	Unchecked by default	Check the Enable checkbox to activate the policy rule.
Save	NA	Click the Save button to save the configuration
Undo	NA	Click the Undo button to restore what you just configured back to the previous setting.

4G IIoT LoRa Gateway

2.2 LAN & VLAN

This section provides the configuration of LAN and VLAN. VLAN is an optional feature, and it depends on the product specification of the purchased gateway.

2.2.1 Ethernet LAN

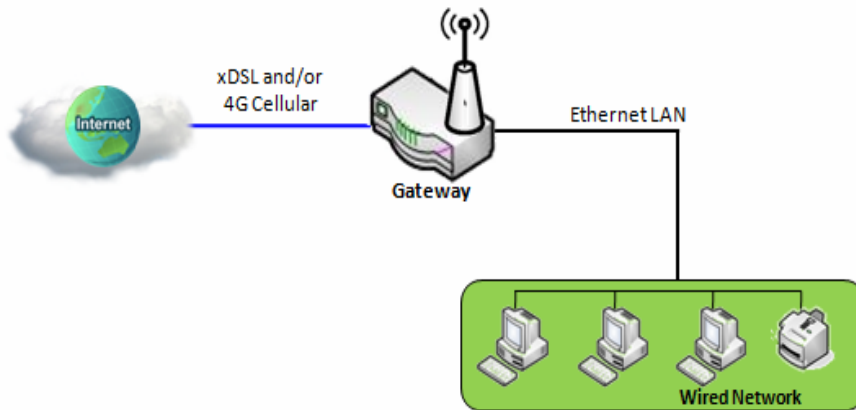

The Local Area Network (LAN) can be used to share data or files among computers attached to a network. Following diagram illustrates the network that wired and interconnects computers.

Please follow the following instructions to do IPv4 Ethernet LAN Setup.

Configuration	
Item	Setting
▶ IP Mode	Static IP
▶ LAN IP Address	<input type="text" value="192.168.123.254"/>
▶ Subnet Mask	<input type="text" value="255.255.255.0 (/24)"/>

Configuration		
Item	Value setting	Description
IP Mode	N/A	It shows the LAN IP mode for the gateway according the related configuration. Static IP: If there is at least one WAN interface activated, the LAN IP mode is fixed in Static IP mode. Dynamic IP: If all the available WAN interfaces are disabled, the LAN IP mode can be Dynamic IP mode.
LAN IP Address	1. A Must filled setting 2. 192.168.123.254 is set by default	Enter the local IP address of this device. The network device(s) on your network must use the LAN IP address of this device as their Default Gateway. You can change it if necessary. Note: It's also the IP address of web UI. If you change it, you need to type new IP address in the browser to see web UI.
Subnet Mask	1. A Must filled setting 2. 255.255.255.0 (/24) is set	Select the subnet mask for this gateway from the dropdown list. Subnet mask defines how many clients are allowed in one network or subnet.

4G IIoT LoRa Gateway

	by default	The default subnet mask is 255.255.255.0 (/24), and it means maximum 254 IP addresses are allowed in this subnet. However, one of them is occupied by LAN IP address of this gateway, so there are maximum 253 clients allowed in LAN network. Value Range: 255.0.0.0 (/8) ~ 255.255.255.252 (/30).
Save	N/A	Click the Save button to save the configuration
Undo	N/A	Click the Undo button to restore what you just configured back to the previous setting.

Create / Edit Additional IP

This gateway provides the LAN IP alias function for some special management consideration. You can add additional LAN IP for this gateway, and access to this gateway with the additional IP.

Additional IP
Add Delete
↑ ×

ID	Name	Interface	IP Address	Subnet Mask	Enable	Action
----	------	-----------	------------	-------------	--------	--------

When **Add** button is applied, **Additional IP Configuration** screen will appear.

Additional IP Configuration
↑ ×

Item	Setting
▶ Name	<input type="text"/>
▶ Interface	lo ▼
▶ IP Address	<input type="text"/>
▶ Subnet Mask	255.255.255.0 (/24) ▼
▶ Enable	<input type="checkbox"/>

Configuration		
Item	Value setting	Description
Name	.1 An Optional Setting	Enter the name for the alias IP address.
Interface	1. A Must filled setting 2. lo is set by default	Specify the Interface type. It can be lo or br0 .
IP Address	1. An Optional setting 2. 192.168.123.254 is set by default	Enter the addition IP address for this device.
Subnet Mask	1. A Must filled setting 2. 255.255.255.0 (/24) is set by default	Select the subnet mask for this gateway from the dropdown list. Subnet mask defines how many clients are allowed in one network or subnet. The default subnet mask is 255.255.255.0 (/24), and it means maximum 254 IP addresses are allowed in this subnet. However, one of them is occupied by LAN IP address of this gateway, so there are maximum 253 clients allowed in LAN

4G IIoT LoRa Gateway

		network. <i>Value Range:</i> 255.0.0.0 (/8) ~ 255.255.255.255 (/32).
Save	NA	Click the Save button to save the configuration

4G IIoT LoRa Gateway

2.2.2 VLAN

VLAN (Virtual LAN) is a logical network under a certain switch or router device to group client hosts with a specific VLAN ID. This gateway supports both Port-based VLAN and Tag-based VLAN. These functions allow you to divide local network into different “virtual LANs”. It is common requirement for some application scenario. For example, there are various departments within SMB. All client hosts in the same department should own common access privilege and QoS property. You can assign departments either by port-based VLAN or tag-based VLAN as a group, and then configure it by your plan. In some cases, ISP may need router to support “VLAN tag” for certain kinds of services (e.g. IPTV). You can group all devices required this service as one tag-based VLAN.

If the gateway has only one physical Ethernet LAN port, only very limited configuration is available if you enable the Port-based VLAN.

➤ Port-based VLAN

Port-based VLAN function can group Ethernet ports, Port-1 ~ Port-4, and WiFi Virtual Access Points, VAP-1 ~ VAP-8, together for differentiated services like Internet surfing, multimedia enjoyment, VoIP talking, and so on. Two operation modes, NAT and Bridge, can be applied to each VLAN group. One DHCP server can be allocated for a NAT VLAN group to let group host member get its IP address. Thus, each host can surf Internet via the NAT mechanism of business access gateway. In bridge mode, Intranet packet flow is delivered out WAN trunk port with VLAN tag to upper link for different services.

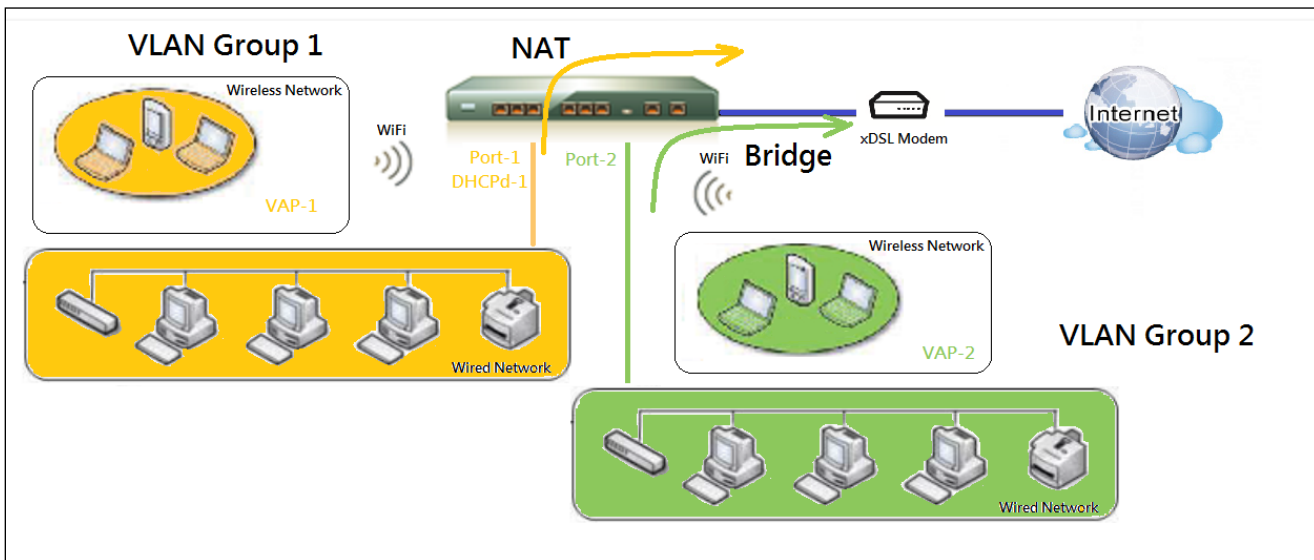

A port-based VLAN is a group of ports on an Ethernet or Virtual APs of Wired or Wireless Gateway that form a logical LAN segment. Following is an example.

For example, in a company, administrator schemes out 3 network segments, Lobby/Meeting Room, Office, and Data Center. In a Wireless Gateway, administrator can configure Lobby/Meeting Room segment with VLAN ID 3. The VLAN group includes Port-3 and VAP-8 (SSID: Guest) with NAT mode and DHCP-3 server equipped. He also configure Office segment with VLAN ID 2. The VLAN group includes Port-2 and VAP-1 (SSID:

4G IIoT LoRa Gateway

Staff) with NAT mode and DHCP-2 server equipped. At last, administrator also configure Data Center segment with VLAN ID 1. The VLAN group includes Port-1 with NAT mode to WAN interface as shown in following diagram.

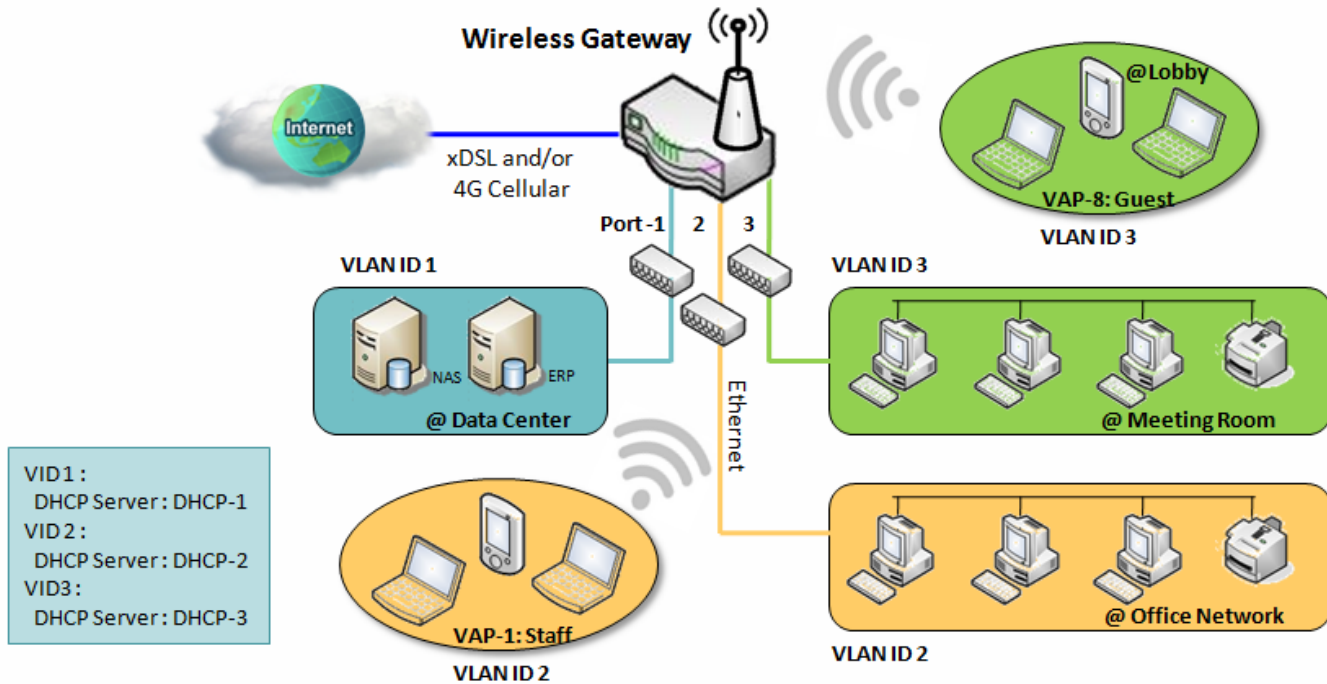

Above is the general case for 3 Ethernet LAN ports in the gateway. But if the device just has one Ethernet LAN port, there will be only one VLAN group for the device. Under such situation, it still supports both the NAT and Bridge mode for the Port-based VLAN configuration.

➤ Tag-based VLAN

Tag-based VLAN function can group Ethernet ports, Port-1 ~ Port-4, and WiFi Virtual Access Points, VAP-1 ~ VAP-8, together with different VLAN tags for deploying subnets in Intranet. All packet flows can carry with different VLAN tags even at the same physical Ethernet port for Intranet. These flows can be directed to different destination because they have differentiated tags. The approach is very useful to group some hosts at different geographic location to be in the same workgroup.

Tag-based VLAN is also called a VLAN Trunk. The VLAN Trunk collects all packet flows with different VLAN IDs from Router device and delivers them in the Intranet. VLAN membership in a tagged VLAN is determined by VLAN ID information within the packet frames that are received on a port. Administrator can further use a VLAN switch to separate the VLAN trunk to different groups based on VLAN ID. Following is an example.

4G IIoT LoRa Gateway

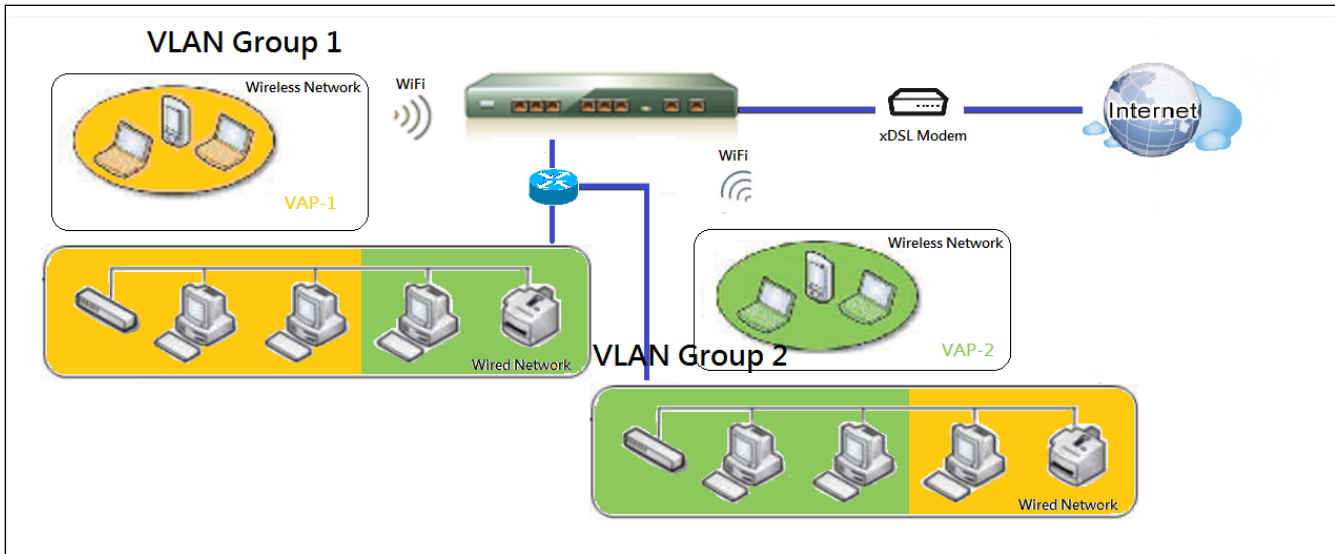

For example, in a company, administrator schemes out 3 network segments, Lab, Meeting Rooms, and Office. In a Security VPN Gateway, administrator can configure Office segment with VLAN ID 12. The VLAN group is equipped with DHCP-3 server to construct a 192.168.12.x subnet. He also configure Meeting Rooms segment with VLAN ID 11. The VLAN group is equipped with DHCP-2 server to construct a 192.168.11.x subnet for Intranet only. That is, any client host in VLAN 11 group can't access the Internet. At last, he configures Lab segment with VLAN ID 10. The VLAN group is equipped with DHCP-1 server to construct a 192.168.10.x subnet.

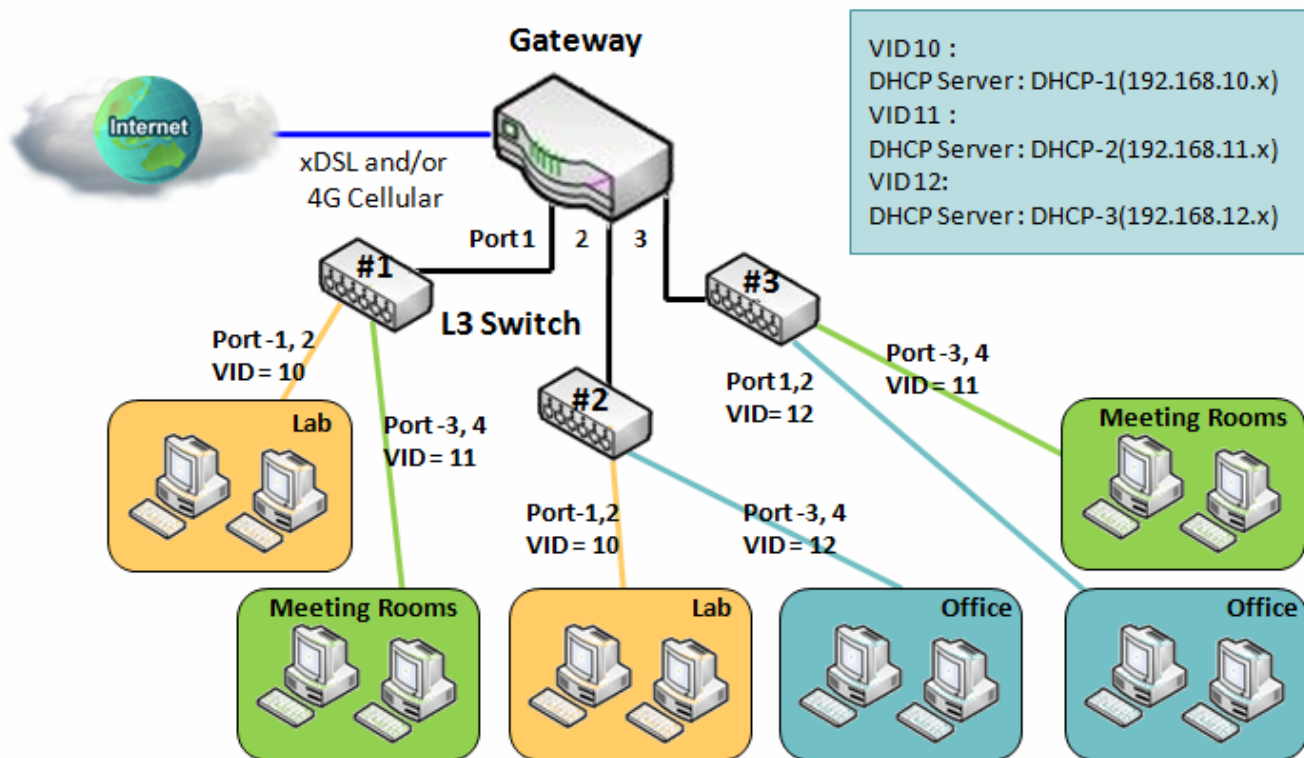

4G IIoT LoRa Gateway

➤ VLAN Groups Access Control

Administrator can specify the Internet access permission for all VLAN groups. He can also configure which VLAN groups are allowed to communicate with each other.

VLAN Group Internet Access

Administrator can specify members of one VLAN group to be able to access Internet or not. Following is an example that VLAN groups of VID is 2 and 3 can access Internet but the one with VID is 1 cannot access Internet. That is, visitors in meeting room and staffs in office network can access Internet. But the computers/servers in data center cannot access Internet since security consideration. Servers in data center only for trusted staffs or are accessed in secure tunnels.

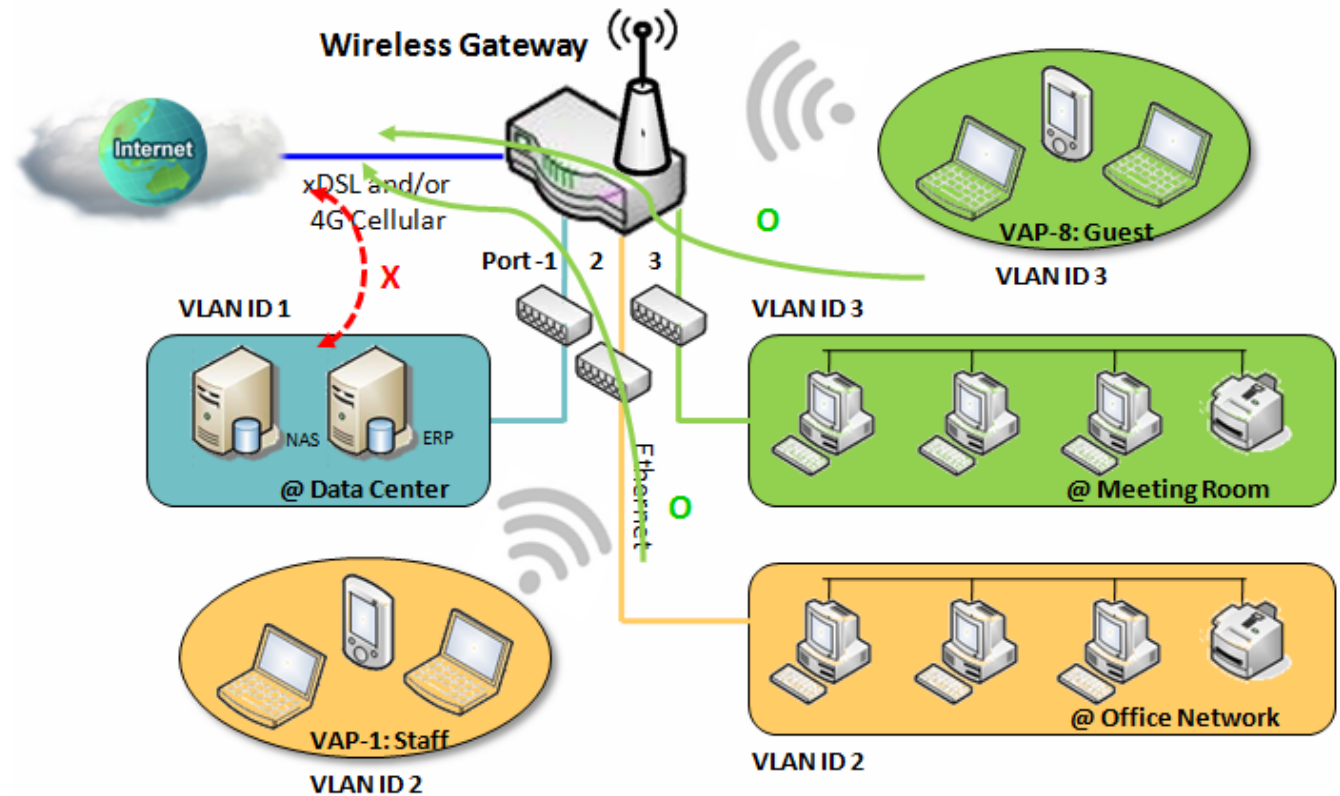

4G IIoT LoRa Gateway

Inter VLAN Group Routing:

In Port-based tagging, administrator can specify member hosts of one VLAN group to be able to communicate with the ones of another VLAN group or not. This is a communication pair, and one VLAN group can join many communication pairs. But communication pair doesn't have the transitive property. That is, A can communicate with B, and B can communicate with C, it doesn't imply that A can communicate with C. An example is shown at following diagram. VLAN groups of VID is 1 and 2 can access each other but the ones between VID 1 and VID 3 and between VID 2 and VID 3 can't.

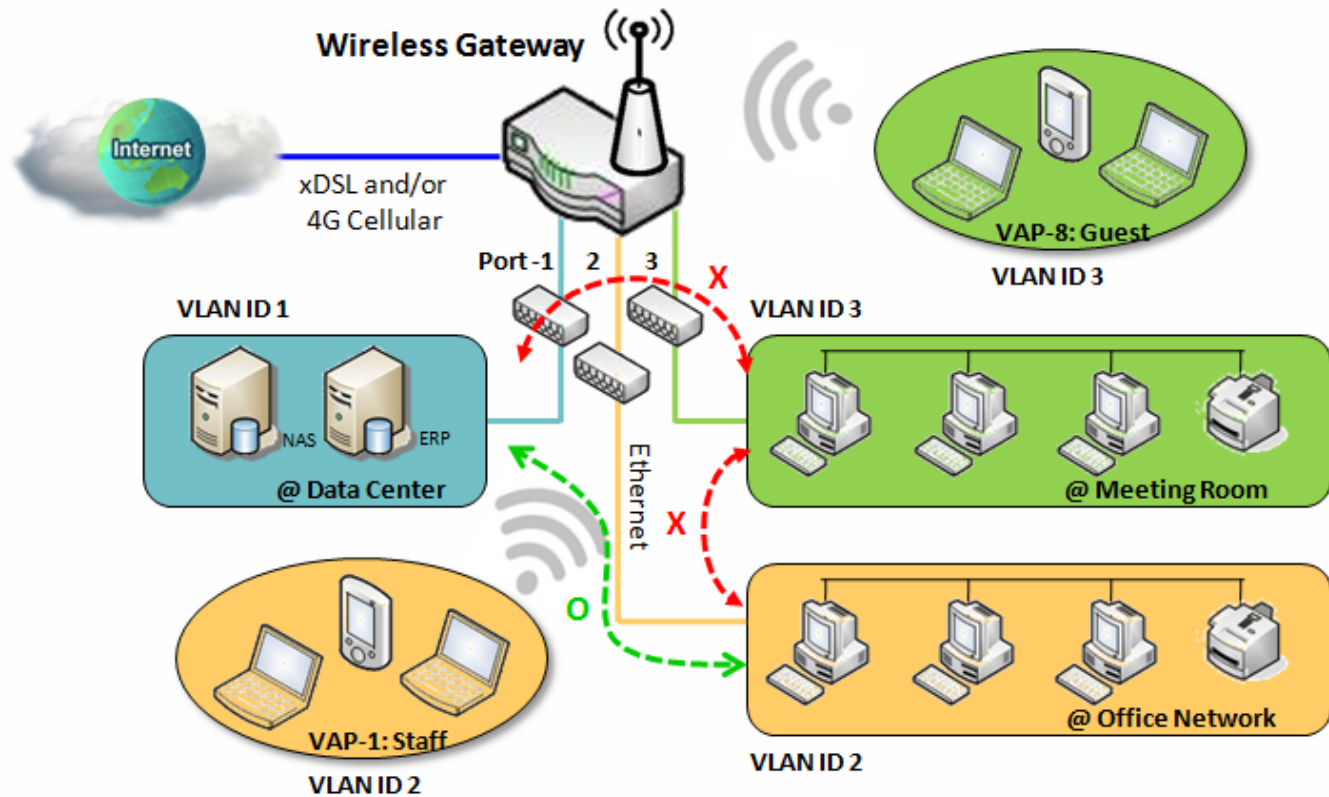

4G IIoT LoRa Gateway

VLAN Setting

Go to **Basic Network > LAN & VLAN > VLAN** Tab.

The VLAN function allows you to divide local network into different virtual LANs. There are Port-based and Tag-based VLAN types. Select one that applies.

Configuration

Item	Setting
VLAN Types	Port-based ▼
System Reserved VLAN ID	Start ID <input type="text" value="1"/> (1-4091) ~ End ID <input type="text" value="5"/>

Item	Value setting	Description
VLAN Type	Port-based is selected by default	Select the VLAN type that you want to adopt for organizing you local subnets. Port-based: Port-based VLAN allows you to add rule for each LAN port, and you can do advanced control with its VLAN ID. Tag-based: Tag-based VLAN allows you to add VLAN ID, and select member and DHCP Server for this VLAN ID. Go to Tag-based VLAN List table.
System Reserved VLAN ID	1 ~ 5 is reserved by default	Specify the VLAN ID range that is reserved for the system operation. For the Port-based/Tag-based VLAN grouping, only use the ID outside the reserved range. Value Range: 1 ~ 4091.
Save	NA	Click the Save button to save the configuration

Port-based VLAN – Create/Edit VLAN Rules

The port-based VLAN allows you to custom each LAN port. There is a default rule shows the configuration of all LAN ports. Also, if your device has a DMZ port, you will see DMZ configuration, too. The maxima rule numbers is based on LAN port numbers.

Port-based VLAN List

Name	VLAN ID	VLAN Tagging	NAT / Bridge	Port Members	LAN IP Address	Subnet Mask	Joined WAN	WAN VID	Enable	Actions
DMZ	4094	X	NAT	DMZ Port	192.168.6.254	255.255.255.0	WAN - 1	0	<input checked="" type="checkbox"/>	<input type="button" value="Edit"/>
LAN	Native VLAN	X	NAT	<input type="button" value="Detail"/>	192.168.123.254	255.255.255.0	All WANs	0	<input checked="" type="checkbox"/>	<input type="button" value="Edit"/>

When **Add** button is applied, Port-based VLAN Configuration screen will appear, which is including 3 sections: **Port-based VLAN Configuration**, **IP Fixed Mapping Rule List**, and **Inter VLAN Group Routing** (enter through a button)

4G IIoT LoRa Gateway

Port-based VLAN - Configuration

Port-based VLAN Configuration	
Item	Setting
▶ Name	VLAN - 1
▶ VLAN ID	
▶ VLAN Tagging	Disable ▾
▶ NAT / Bridge	NAT ▾
▶ Port Members	Port: <input type="checkbox"/> Port-2 <input type="checkbox"/> Port-3 2.4G: <input type="checkbox"/> VAP-1 <input type="checkbox"/> VAP-2 <input type="checkbox"/> VAP-3 <input type="checkbox"/> VAP-4 <input type="checkbox"/> VAP-5 <input type="checkbox"/> VAP-6 <input type="checkbox"/> VAP-7 <input type="checkbox"/> VAP-8 5G: <input type="checkbox"/> VAP-1 <input type="checkbox"/> VAP-2 <input type="checkbox"/> VAP-3 <input type="checkbox"/> VAP-4 <input type="checkbox"/> VAP-5 <input type="checkbox"/> VAP-6 <input type="checkbox"/> VAP-7 <input type="checkbox"/> VAP-8
▶ LAN to Join	<input type="checkbox"/> Enable <input type="text" value="DHCP 1"/> ▾

Port-based VLAN Configuration (part-I)		
Item	Value setting	Description
Name	1. A Must filled setting 2. String format: already have default texts	Define the Name of this rule. It has a default text and cannot be modified.
VLAN ID	A Must filled setting	Define the VLAN ID number, range is 1~4094.
VLAN Tagging	Disable is selected by default.	The rule is activated according to VLAN ID and Port Members configuration when Enable is selected. The rule is activated according Port Members configuration when Disable is selected.
NAT / Bridge	NAT is selected by default.	Select NAT mode or Bridge mode for the rule.
Port Members	These boxes are unchecked by default.	Select which LAN port(s) and VAP(s) that you want to add to the rule. Note: The available member list can be different for the purchased product.
LAN to Join	The box is unchecked by default.	Check the Enable box and select one of the defined DHCP Server for the List to define the DHCP server for the VLAN group. If you enabled this function, all the rest settings will be greyed out, not required to configured manually.
Save	NA	Click the Save button to save the configuration
Undo	NA	Click the Undo button to restore what you just configured back to the previous setting.

If you didn't decide to bind the VLAN group to a pre-defined DHCP server, you have to further specify the following settings.

4G IIoT LoRa Gateway

▶ WAN & WAN VID to Join	All WANs ▾ None
▶ LAN IP Address	192.168.2.254
▶ Subnet Mask	255.255.255.0 (/24) ▾
▶ DHCP Server / Relay	Server ▾
▶ DHCP Server Name	
▶ IP Pool	Starting Address: 192.168.2.100 Ending Address: 192.168.2.200
▶ Lease Time	86400 seconds
▶ Domain Name	(Optional)
▶ Primary DNS	(Optional)
▶ Secondary DNS	(Optional)
▶ Primary WINS	(Optional)
▶ Secondary WINS	(Optional)
▶ Gateway	(Optional)
▶ Enable	<input type="checkbox"/>

Port-based VLAN Configuration (part-II)		
Item	Value setting	Description
WAN & WAN VID to Join	All WANs is selected by default.	Select which WAN or All WANs that allow accessing Internet. Note: If Bridge mode is selected, you need to select a WAN and enter a VID.
LAN IP Address	A Must filled setting	Assign an IP Address for the DHCP Server that the rule used, this IP address is a gateway IP.
Subnet Mask	255.255.255.0(/24) is selected by default.	Select a Subnet Mask for the DHCP Server.
DHCP Server /Relay	Server is selected by default.	Define the DHCP Server type. There are three types you can select: Server , Relay , and Disable . Relay : Select Relay to enable DHCP Relay function for the VLAN group, and you only need to fill the DHCP Server IP Address field. Server : Select Server to enable DHCP Server function for the VLAN group, and you need to specify the DHCP Server settings. Disable : Select Disable to disable the DHCP Server function for the VLAN group.
DHCP Server IP Address (for DHCP Relay only)	A Must filled setting	If you select Relay type of DHCP Server, assign a DHCP Server IP Address that the gateway will relay the DHCP requests to the assigned DHCP server.
DHCP Option 82 (for DHCP Relay only)	An Optional filled setting	If you select Relay type of DHCP Server, you can further enable the DHCP Option 82 setting if the DHCP server support it.
DHCP Server Name	A Must filled setting	Define name of the DHCP Server for the specified VLAN group.
IP Pool	A Must filled setting	Define the IP Pool range. There are Starting Address and Ending Address fields. If a client requests an IP address from this DHCP Server, it will assign an IP address in the range of IP pool .

4G IIoT LoRa Gateway

Lease Time	A Must filled setting	Define a period of time for an IP Address that the DHCP Server leases to a new device. By default, the lease time is 86400 seconds.
Domain Name	String format can be any text	The Domain Name of this DHCP Server. <u>Value Range:</u> 0 ~ 31 characters.
Primary DNS	IPv4 format	The Primary DNS of this DHCP Server.
Secondary DNS	IPv4 format	The Secondary DNS of this DHCP Server.
Primary WINS	IPv4 format	The Primary WINS of this DHCP Server.
Secondary WINS	IPv4 format	The Secondary WINS of this DHCP Server.
Gateway	IPv4 format	The Gateway of this DHCP Server.
Enable	The box is unchecked by default.	Click Enable box to activate this rule.
Save	NA	Click the Save button to save the configuration
Undo	NA	Click the Undo button to restore what you just configured back to the previous setting.

4G IIoT LoRa Gateway

Besides, you can add some IP rules in the **IP Fixed Mapping Rule List** if DHCP Server for the VLAN groups is required.

IP Fixed Mapping Rule List Add Delete			
MAC Address	IP Address	Enable	Actions

When **Add** button is applied, **Mapping Rule Configuration** screen will appear.

Mapping Rule Configuration		
Item	Value setting	Description
MAC Address	A Must filled setting	Define the MAC Address target that the DHCP Server wants to match.
IP Address	A Must filled setting	Define the IP Address that the DHCP Server will assign. If there is a request from the MAC Address filled in the above field, the DHCP Server will assign this IP Address to the client whose MAC Address matched the rule.
Enable	The box is unchecked by default.	Click Enable box to activate this rule.
Save	NA	Click the Save button to save the configuration

Note: ensure to always click on **Apply** button to apply the changes after the web browser refreshed taken you back to the VLAN page.

Port-based VLAN List Add Delete ↑ ×										
Name	VLAN ID	VLAN Tagging	NAT / Bridge	Port Members	LAN IP Address	Subnet Mask	Joined WAN	WAN VID	Enable	Actions
LAN	Native VLAN Tag 1	X	NAT	Detail	192.168.66.1	255.255.254.0	All WANs	0	<input checked="" type="checkbox"/>	Edit

Apply Inter VLAN Group Routing

4G IIoT LoRa Gateway

Port-based VLAN – Inter VLAN Group Routing

Click **VLAN Group Routing** button, the **VLAN Group Internet Access Definition** and **Inter VLAN Group Routing** screen will appear.

VLAN Group Internet Access Definition		
VLAN IDs	Members	Internet Access(WAN)
1	Port : 2,3 2.4G VAP: 1,2,3,4,5,6,7,8 5G VAP: 1,2,3,4,5,6,7,8	Allow <input type="button" value="Edit"/>

Inter VLAN Group Routing		
VLAN IDs	Members	Action
		<input type="button" value="Edit"/>
		<input type="button" value="Edit"/>
		<input type="button" value="Edit"/>
		<input type="button" value="Edit"/>

When **Edit** button is applied, a screen similar to this will appear.

VLAN Group Internet Access Definition		
VLAN IDs	Members	Internet Access(WAN)
<input checked="" type="checkbox"/> 1	Port : 2,3 2.4G VAP: 1,2,3,4,5,6,7,8 5G VAP: 1,2,3,4,5,6,7,8	Allow <input type="button" value="Edit"/>

Inter VLAN Group Routing		
VLAN IDs	Members	Action
<input type="checkbox"/> 1		<input type="button" value="Edit"/>
		<input type="button" value="Edit"/>
		<input type="button" value="Edit"/>
		<input type="button" value="Edit"/>

Inter VLAN Group Routing		
Item	Value setting	Description
VALN Group Internet Access Definition	All boxes are checked by default.	By default, all boxes are checked means all VLAN ID members are allow to access WAN interface. If uncheck a certain VLAN ID box, it means the VLAN ID member can't access Internet anymore.

4G IIoT LoRa Gateway

		Note: VLAN ID 1 is available always; it is the default VLAN ID of LAN rule. The other VLAN IDs are available only when they are enabled.
Inter VLAN Group Routing	The box is unchecked by default.	Click the expected VLAN IDs box to enable the Inter VLAN access function. By default, members in different VLAN IDs can't access each other. The gateway supports up to 4 rules for Inter VLAN Group Routing . For example, if ID_1 and ID_2 are checked, it means members in VLAN ID_1 can access members of VLAN ID_2, and vice versa.
Save	N/A	Click the Save button to save the configuration

Tag-based VLAN – Create/Edit VLAN Rules

The **Tag-based VLAN** allows you to customize each LAN port according to VLAN ID. There is a default rule shows the configuration of all LAN ports and all VAPs. Also, if your device has a DMZ port, you will see DMZ configuration, too. The router supports up to a maximum of 128 tag-based VLAN rule sets.

Tag-based VLAN List						
VLAN ID	Internet	Port Members	Bridge Interface	IP Address	Subnet Mask	Actions
Native VLAN	<input checked="" type="checkbox"/>	Port: <input checked="" type="checkbox"/> Port-2 <input checked="" type="checkbox"/> Port-3 2.4G: <input checked="" type="checkbox"/> VAP-1 <input checked="" type="checkbox"/> VAP-2 <input checked="" type="checkbox"/> VAP-3 <input checked="" type="checkbox"/> VAP-4 <input checked="" type="checkbox"/> VAP-5 <input checked="" type="checkbox"/> VAP-6 <input checked="" type="checkbox"/> VAP-7 <input checked="" type="checkbox"/> VAP-8 5G: <input checked="" type="checkbox"/> VAP-1 <input checked="" type="checkbox"/> VAP-2 <input checked="" type="checkbox"/> VAP-3 <input checked="" type="checkbox"/> VAP-4 <input checked="" type="checkbox"/> VAP-5 <input checked="" type="checkbox"/> VAP-6 <input checked="" type="checkbox"/> VAP-7 <input checked="" type="checkbox"/> VAP-8	DHCP 1			<input type="button" value="Edit"/> <input type="button" value="Select"/>

When **Add** button is applied, **Tag-based VLAN Configuration** screen will appear.

Tag-based VLAN Configuration	
Item	Setting
VLAN ID	<input type="text" value="0"/>
Internet Access	<input checked="" type="checkbox"/> Enable
Port Members	Port: <input type="checkbox"/> Port-2 <input type="checkbox"/> Port-3 2.4G: <input type="checkbox"/> VAP-1 <input type="checkbox"/> VAP-2 <input type="checkbox"/> VAP-3 <input type="checkbox"/> VAP-4 <input type="checkbox"/> VAP-5 <input type="checkbox"/> VAP-6 <input type="checkbox"/> VAP-7 <input type="checkbox"/> VAP-8 5G: <input type="checkbox"/> VAP-1 <input type="checkbox"/> VAP-2 <input type="checkbox"/> VAP-3 <input type="checkbox"/> VAP-4 <input type="checkbox"/> VAP-5 <input type="checkbox"/> VAP-6 <input type="checkbox"/> VAP-7 <input type="checkbox"/> VAP-8
Bridge Interface	<input type="text" value="DHCP 1"/>

Tag-based VLAN Configuration (Part-I)		
Item	Value setting	Description
VALN ID	A Must filled setting	Define the VLAN ID number, that is outside the system reserved range. Value Range: 1 ~ 4095.
Internet Access	The box is checked by default.	Click Enable box to allow the members in the VLAN group access to internet.
Port Members	The boxes are unchecked by default.	Check the LAN port box(es) to join the VLAN group. Check the VAP box(es) to join the VLAN group. Note: Only the wireless gateway has the VAP list.
Bridge Interface	DHCP 1 is selected by default.	Select a predefined DHCP Server , a New to defined a new DHCP server for these members of this VLAN group.
Save	N/A	Click Save button to save the configuration Note: After clicking Save button, always click Apply button to apply the settings.

4G IIoT LoRa Gateway

If you select New to create a new DHCP server setting for the VLAN group, you have to further specify the following configuration.

▶ IP Address	<input type="text"/>
▶ Subnet Mask	255.255.255.0 (/24) ▼
▶ DHCP Relay	<input type="checkbox"/> Enable & Server IP : <input type="text"/>
▶ WAN Interface	WAN - 1 ▼
▶ DHCP Relay Option 82	<input type="checkbox"/> Enable

Tag-based VLAN Configuration (part-II)		
Item	Value setting	Description
IP Address	A Must filled setting	Assign an IP Address for the DHCP Server that the rule used, this IP address is a gateway IP.
Subnet Mask	255.255.255.0(/24) is selected by default.	Select a Subnet Mask for the DHCP Server.
DHCP Relay	The box is unchecked by default.	Check the box to enable the DHCP Relay function for the VLAN group, and you only need to fill the DHCP Server IP Address field.
WAN Interface	WAN-1 is selected by default.	Select which WAN interface that allow accessing Internet.
DHCP Option 82	An Optional filled setting	If you select Relay type of DHCP Server, you can further enable the DHCP Option 82 setting if the DHCP server support it.
Save	NA	Click the Save button to save the configuration
Undo	NA	Click the Undo button to restore what you just configured back to the previous setting.

Tag-based VLAN Summary

The configured tag-based VLAN group information will be displayed in the following screen.

Tag-based VLAN Summary	
Port	VLAN IDs
Port2	Native VLAN
Port3	Native VLAN

4G IIoT LoRa Gateway

2.2.3 DHCP Server

➤ DHCP Server

The gateway supports up to 4 DHCP servers to fulfill the DHCP requests from different VLAN groups (please refer to VLAN section for getting more usage details). And there is one default setting for whose LAN IP Address is the same one of gateway LAN interface, with its default Subnet Mask setting as “255.255.255.0”, and its default IP Pool ranges is from “.100” to “.200” as shown at the DHCP Server List page on gateway’s WEB UI.

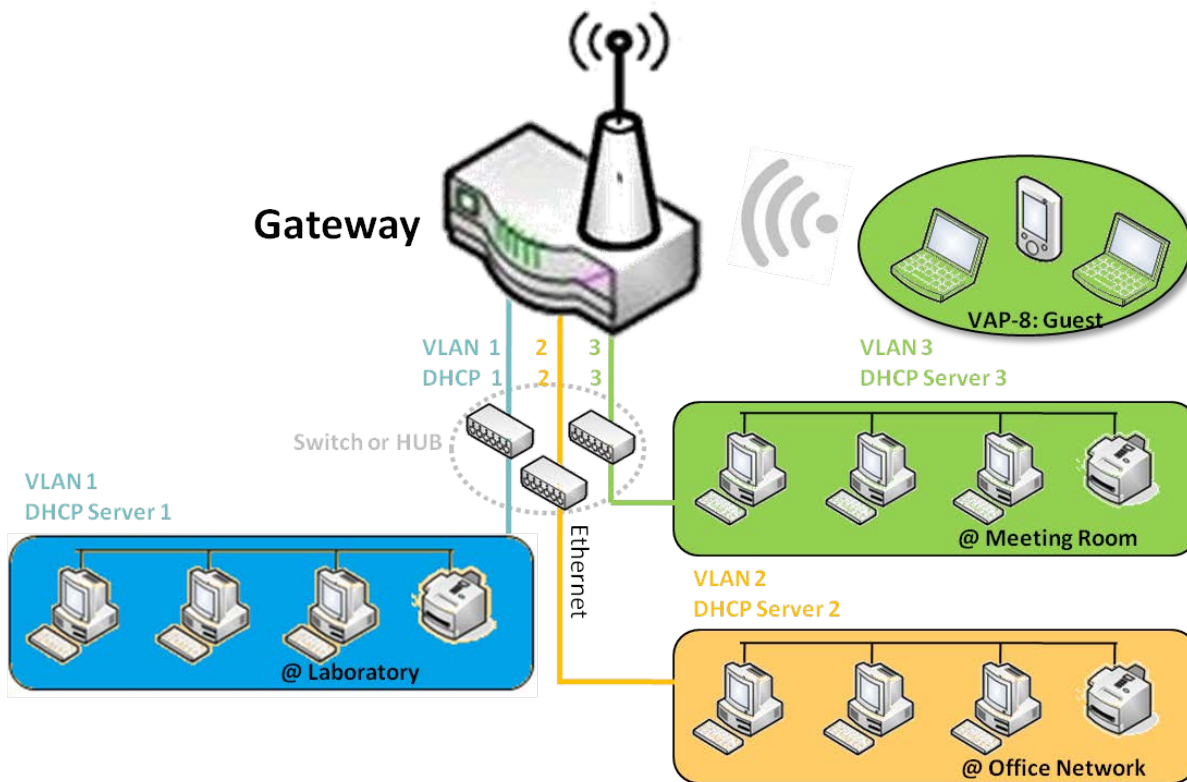

User can add more DHCP server configurations by clicking on the “Add” button behind “DHCP Server List”, or clicking on the “Edit” button at the end of each DHCP Server on list to edit its current settings. Besides, user can select a DHCP Server and delete it by clicking on the “Select” check-box and the “Delete” button.

4G IIoT LoRa Gateway

➤ Fixed Mapping

User can assign fixed IP address to map the specific client MAC address by select them then copy, when targets were already existed in the **DHCP Client List**, or to add some other Mapping Rules by manually in advance, once the target's MAC address was not ready to connect.

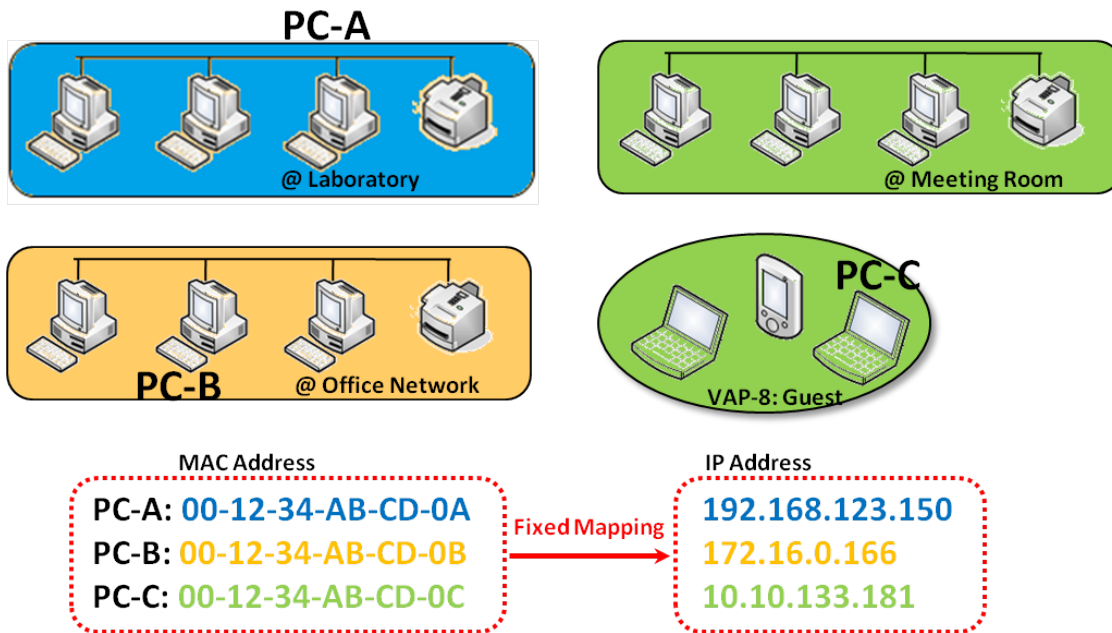

4G IIoT LoRa Gateway

DHCP Server Setting

Go to **Basic Network > LAN & VLAN > DHCP Server** Tab.

The DHCP Server setting allows user to create and customize DHCP Server policies to assign IP Addresses to the devices on the local area network (LAN).

Create / Edit DHCP Server Policy

The gateway allows you to custom your DHCP Server Policy. If multiple LAN ports are available, you can define one policy for each LAN (or VLAN group), and it supports up to a maximum of 4 policy sets.

DHCP Server List												
DHCP Server Name	LAN IP Address	Subnet Mask	IP Pool	Lease Time	Domain Name	Primary DNS	Secondary DNS	Primary WINS	Secondary WINS	Gateway	Enable	Actions
DHCP 1	192.168.66.1	255.255.254.0	192.168.66.100-192.168.66.200	900		0.0.0.0	0.0.0.0	0.0.0.0	0.0.0.0	0.0.0.0	<input checked="" type="checkbox"/>	Edit Fixed Mapping

When **Add** button is applied, **DHCP Server Configuration** screen will appear.

DHCP Server Configuration	
Item	Setting
▶ DHCP Server Name	<input type="text" value="DHCP 2"/>
▶ LAN IP Address	<input type="text" value="192.168.2.1"/>
▶ Subnet Mask	<input type="text" value="255.255.255.0 (/24)"/>
▶ IP Pool	Starting Address: <input type="text"/> Ending Address: <input type="text"/>
▶ Lease Time	<input type="text" value="86400"/> seconds
▶ Domain Name	<input type="text"/> (Optional)
▶ Primary DNS	<input type="text"/> (Optional)
▶ Secondary DNS	<input type="text"/> (Optional)
▶ Primary WINS	<input type="text"/> (Optional)
▶ Secondary WINS	<input type="text"/> (Optional)
▶ Gateway	<input type="text"/> (Optional)

4G IIoT LoRa Gateway

DHCP Server Configuration		
Item	Value setting	Description
DHCP Server Name	1. String format can be any text 2. A Must filled setting	Enter a DHCP Server name. Enter a name that is easy for you to understand.
LAN IP Address	1. IPv4 format. 2. A Must filled setting	The LAN IP Address of this DHCP Server.
Subnet Mask	255.0.0.0 (/8) is set by default	The Subnet Mask of this DHCP Server.
IP Pool	1. IPv4 format. 2. A Must filled setting	The IP Pool of this DHCP Server. It composed of Starting Address entered in this field and Ending Address entered in this field.
Lease Time	1. Numeric string format. 2. A Must filled setting	The Lease Time of this DHCP Server. Value Range: 300 ~ 604800 seconds.
Domain Name	String format can be any text	The Domain Name of this DHCP Server.
Primary DNS	IPv4 format	The Primary DNS of this DHCP Server.
Secondary DNS	IPv4 format	The Secondary DNS of this DHCP Server.
Primary WINS	IPv4 format	The Primary WINS of this DHCP Server.
Secondary WINS	IPv4 format	The Secondary WINS of this DHCP Server.
Gateway	IPv4 format	The Gateway of this DHCP Server.
Server	The box is unchecked by default.	Click Enable box to activate this DHCP Server.
Save	N/A	Click the Save button to save the configuration
Undo	N/A	Click the Undo button to restore what you just configured back to the previous setting.
Back	N/A	When the Back button is clicked the screen will return to the DHCP Server Configuration page.

Create / Edit Mapping Rule List on DHCP Server

The gateway allows you to custom your Mapping Rule List on DHCP Server. It supports up to a maximum of 64 rule sets. When **Fix Mapping** button is applied, the **Mapping Rule List** screen will appear.



When **Add** button is applied, **Mapping Rule Configuration** screen will appear.

4G IIoT LoRa Gateway

Mapping Rule Configuration	
Item	Setting
▶ MAC Address	<input type="text"/>
▶ IP Address	<input type="text"/>
▶ Rule	<input type="checkbox"/> Enable

Mapping Rule Configuration		
Item	Value setting	Description
MAC Address	1. MAC Address string format 2. A Must filled setting	The MAC Address of this mapping rule.
IP Address	1. IPv4 format. 2. A Must filled setting	The IP Address of this mapping rule.
Rule	The box is unchecked by default.	Click Enable box to activate this rule.
Save	N/A	Click the Save button to save the configuration
Undo	N/A	Click the Undo button to restore what you just configured back to the previous setting.
Back	N/A	When the Back button is clicked the screen will return to the DHCP Server Configuration page.

View / Copy DHCP Client List

When **DHCP Client List** button is applied, **DHCP Client List** screen will appear.

DHCP Client List Copy to Fixed Mapping					
LAN Interface	IP Address	Host Name	MAC Address	Remaining Lease Time	Actions
Ethernet	Dynamic /192.168.123.100	James-P45V	74:D0:2B:62:8D:42	00:49:07	<input type="checkbox"/> Select

DHCP Client List Copy to Fixed Mapping					
LAN Interface	IP Address	Host Name	MAC Address	Remaining Lease Time	Actions

When the DHCP Client is selected and **Copy to Fixed Mapping** button is applied. The IP and MAC address of DHCP Client will apply to the Mapping Rule List on specific DHCP Server automatically.

Enable / Disable DHCP Server Options

The **DHCP Server Options** setting allows user to set **DHCP OPTIONS 66, 72, or 114**. Click the **Enable** button to activate the DHCP option function, and the DHCP Server will add the expected options in its sending out DHCPOFFER DHCPACK packages.

4G IIoT LoRa Gateway

Option	Meaning	RFC
66	TFTP server name	[RFC 2132]
72	Default World Wide Web Server	[RFC 2132]
114	URL	[RFC 3679]

Configuration	
Item	Setting
▶ DHCP Server Options	<input type="checkbox"/> Enable

Create / Edit DHCP Server Options

The gateway supports up to a maximum of 99 option settings.

DHCP Server Option List							
ID	Option Name	DHCP Server Select	Option Select	Type	Value	Enable	Actions
<div style="text-align: right;"> Add Delete </div>							

When **Add/Edit** button is applied, **DHCP Server Option Configuration** screen will appear.

DHCP Server Option Configuration	
Item	Setting
▶ Option Name	<input type="text" value="Option 1"/>
▶ DHCP Server Select	<input type="text" value="DHCP 1"/>
▶ Option Select	<input type="text" value="DHCP OPTION 66"/>
▶ Type	<input type="text" value="Single IP Address"/>
▶ Value	<input type="text"/>
▶ Enable	<input type="checkbox"/> Enable

DHCP Server Option Configuration		
Item	Value setting	Description
Option Name	<ol style="list-style-type: none"> String format can be any text A Must filled setting. 	Enter a DHCP Server Option name. Enter a name that is easy for you to understand.
DHCP Server Select	Dropdown list of all available DHCP servers.	Choose the DHCP server this option should apply to.
Option Select	<ol style="list-style-type: none"> A Must filled setting. Option 66 is selected by default. 	Choose the specific option from the dropdown list. It can be Option 66, Option 72, Option 144, Option 42, Option 150, or Option 160. Option 42 for ntp server;

4G IIoT LoRa Gateway

		Option 66 for tftp; Option 72 for www; Option 144 for url;														
Type	Dropdown list of DHCP server option value's type	Each different options has different value types.														
		66	Single IP Address													
			Single FQDN													
		72	IP Addresses List, separated by “,”													
		114	Single URL													
		42	IP Addresses List, separated by “,”													
		150	IP Addresses List, separated by “,”													
Value	1. IPv4 format 2. FQDN format 3. IP list 4. URL format 5. A Must filled setting	Should conform to Type :														
			<table border="1"> <thead> <tr> <th>Type</th> <th>Value</th> </tr> </thead> <tbody> <tr> <td rowspan="2">66</td> <td>Single IP Address</td> <td>IPv4 format</td> </tr> <tr> <td>Single FQDN</td> <td>FQDN format</td> </tr> <tr> <td>72</td> <td>IP Addresses List, separated by “,”</td> <td>IPv4 format, separated by “,”</td> </tr> <tr> <td>114</td> <td>Single URL</td> <td>URL format</td> </tr> </tbody> </table>	Type	Value	66	Single IP Address	IPv4 format	Single FQDN	FQDN format	72	IP Addresses List, separated by “,”	IPv4 format, separated by “,”	114	Single URL	URL format
		Type	Value													
		66	Single IP Address	IPv4 format												
			Single FQDN	FQDN format												
72	IP Addresses List, separated by “,”	IPv4 format, separated by “,”														
114	Single URL	URL format														
Enable	The box is unchecked by default.	Click Enable box to activate this setting.														
Save	NA	Click the Save button to save the setting.														
Undo	NA	When the Undo button is clicked the screen will return back with nothing changed.														

Create / Edit DHCP Relay

The gateway supports up to a maximum of 6 DHCP Relay configurations.

DHCP Relay Configuration List							Add	Delete	↑	×
ID	Agent Name	LAN interface	WAN interface	Server IP	DHCP Relay Option 82	Enable	Actions			

When **Add/Edit** button is applied, **DHCP Relay Configuration** screen will appear.

4G IIoT LoRa Gateway

DHCP Relay Configuration	
Item	Setting
▶ Agent Name	<input type="text"/>
▶ LAN interface	LAN ▾
▶ WAN interface	WAN - 1 ▾
▶ Server IP	<input type="text"/>
▶ DHCP OPTION 82	<input type="checkbox"/>
▶ Enable	<input type="checkbox"/>

DHCP Relay Configuration		
Item	Value setting	Description
Agent Name	<ol style="list-style-type: none"> String format can be any text A Must filled setting. 	Enter a DHCP Relay name. Enter a name that is easy for you to understand. <u>Value Range:</u> 1~64 characters.
LAN Interface	<ol style="list-style-type: none"> A Must filled setting. LAN is selected by default. 	Choose a LAN Interface for the dropdown list to apply with the DHCP Relay function.
WAN Interface	<ol style="list-style-type: none"> A Must filled setting. WAN-1 is selected by default. 	Choose a WAN Interface for the dropdown list to apply with the DHCP Relay function. It can be the available WAN interface(s), and L2TP connection.
Server IP	<ol style="list-style-type: none"> A Must filled setting. null by default. 	Assign a DHCP Server IP Address that the gateway will relay the DHCP requests to the assigned DHCP server via specified WAN interface.
DHCP OPTION 82	The box is unchecked by default.	Click Enable box to activate DHCP OPTION 82 function. Option 82 is organized as a single DHCP option that contains circuit-ID information known by the relay agent. If the relayed DHCP server required the such information, you have to enable it, otherwise, just leave it as unchecked.
Enable	The box is unchecked by default.	Click Enable box to activate this setting.
Save	NA	Click the Save button to save the setting.
Undo	NA	When the Undo button is clicked the screen will return back with nothing changed.

4G IIoT LoRa Gateway

2.3 WiFi (not supported)

Not supported feature for the purchased product, leave it as blank.

4G IIoT LoRa Gateway

2.4 IPv6

The growth of the Internet has created a need for more addresses than are possible with IPv4. IPv6 (Internet Protocol version 6) is a version of the Internet Protocol (IP) intended to succeed IPv4, which is the protocol currently used to direct almost all Internet traffic. IPv6 also implements additional features not present in IPv4. It simplifies aspects of address assignment (stateless address auto-configuration), network renumbering and router announcements when changing Internet connectivity providers.

2.4.1 IPv6 Configuration

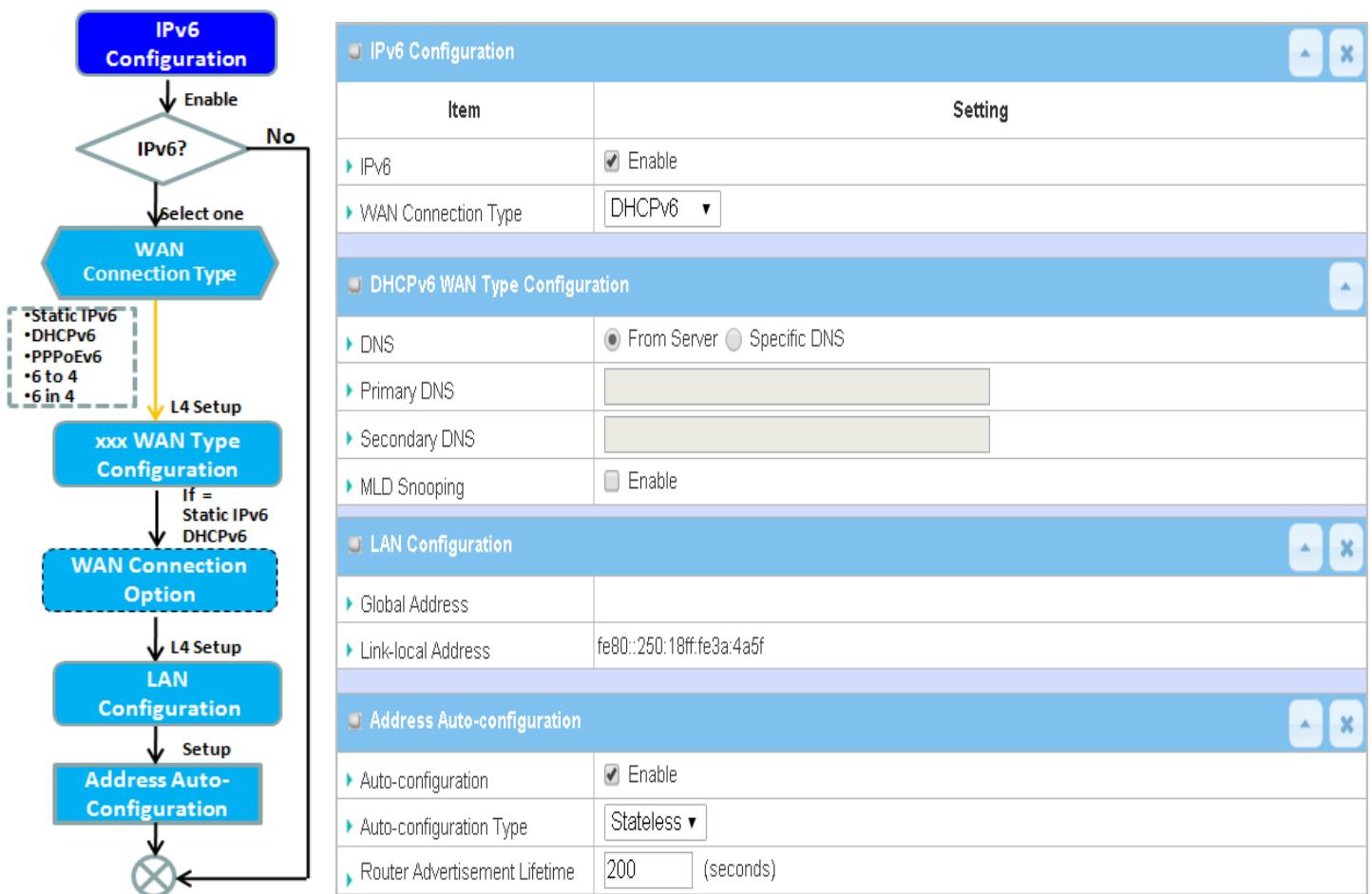

The **IPv6 Configuration** setting allows user to set the IPv6 connection type to access the IPv6 network. This gateway supports various types of IPv6 connection, including **Static IPv6**, **DHCPv6**, and **PPPoEv6**

Note: The available WAN connection types can be different, depending on the Interface type of WAN-1.

4G IIoT LoRa Gateway

IPv6 WAN Connection Type

Static IPv6

Static IPv6 does the same function as static IPv4. The static IPv6 provides manual setting of IPv6 address, IPv6 default gateway address, and IPv6 DNS.

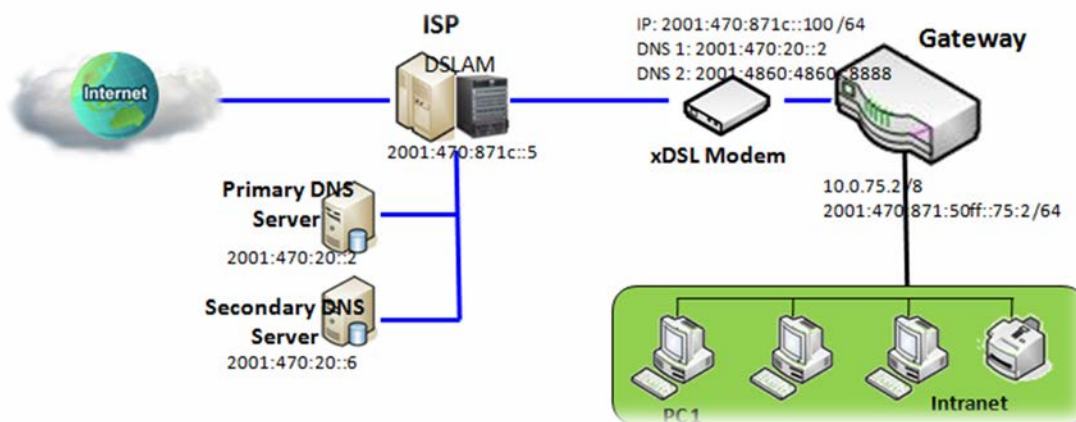

Above diagram depicts the IPv6 IP addressing, type in the information provided by your ISP to setup the IPv6 network.

DHCPv6

DHCP in IPv6 does the same function as DHCP in IPv4. The DHCP server sends IP address, DNS server addresses and other possible data to the DHCP client to configure automatically. The server also sends a lease time of the address and time to re-contact the server for IPv6 address renewal. The client has then to resend a request to renew the IPv6 address.

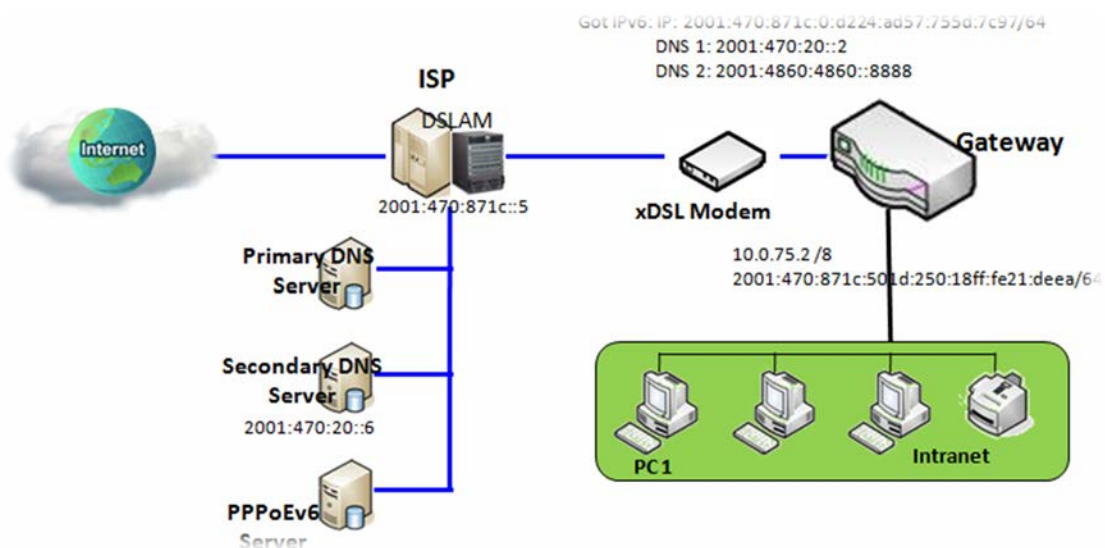

Above diagram depicts DHCP IPv6 IP addressing, the DHCPv6 server on the ISP side assigns IPv6 address, IPv6 default gateway address, and IPv6 DNS to client host's automatically.

4G IIoT LoRa Gateway

PPPoEv6

PPPoEv6 in IPv6 does the same function as PPPoE in IPv4. The PPPoEv6 server provides configuration parameters based on PPPoEv6 client request. When PPPoEv6 server gets client request and successfully authenticates it, the server sends IP address, DNS server addresses and other required parameters to automatically configure the client.

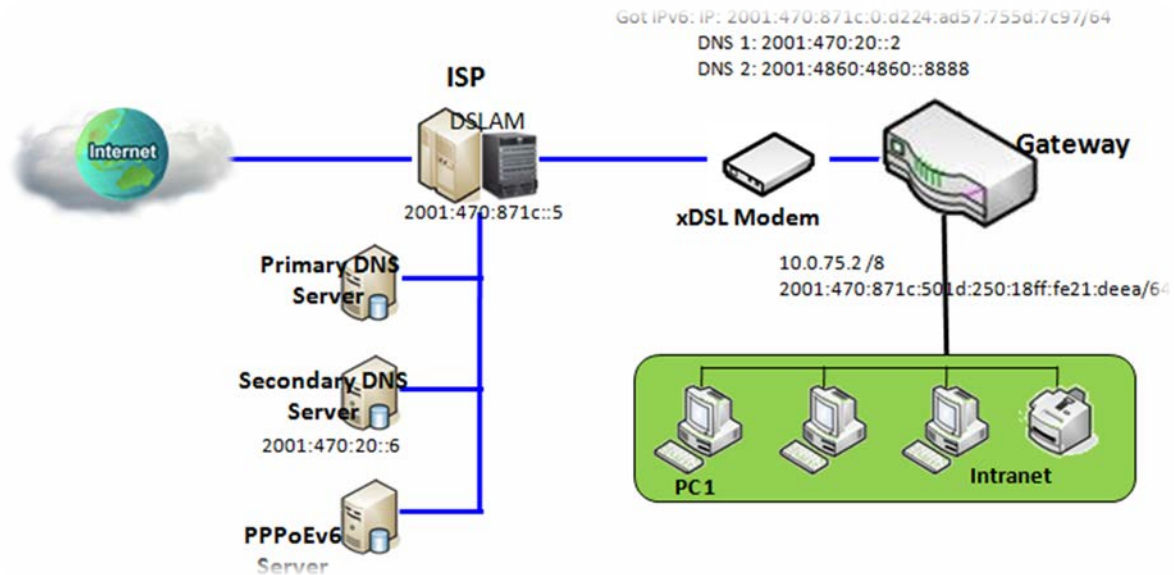

The diagram above depicts the IPv6 addressing through PPPoE, PPPoEv6 server (DSLAM) on the ISP side provides IPv6 configuration upon receiving PPPoEv6 client request. When PPPoEv6 server gets client request and successfully authenticates it, the server sends IP address, DNS server addresses and other required parameters to automatically configure the client.

4G IIoT LoRa Gateway

IPv6 Configuration Setting

Go to **Basic Network > IPv6 > Configuration** Tab.

The **IPv6 Configuration** setting allows user to set the IPv6 connection type to access the IPv6 network.

IPv6 Configuration	
Item	Setting
▶ IPv6	<input checked="" type="checkbox"/> Enable
▶ WAN Connection Type	DHCPv6 ▾

Item	Value setting	Description
IPv6	The box is unchecked by default,	Check the Enable box to activate the IPv6 function.
WAN Connection Type	1. A Must filled setting 2. DHCPv6 is selected by default	Define the selected IPv6 WAN Connection Type to establish the IPv6 connectivity via WAN-1 Interface. Select Static IPv6 when your ISP provides you with a set IPv6 addresses. Select DHCPv6 when your ISP provides you with DHCPv6 services. Select PPPoEv6 when your ISP provides you with PPPoEv6 account settings. Note: The available WAN connection types can be different, depending on the Interface type of WAN-1.

Static IPv6 WAN Type Configuration

Static IPv6 WAN Type Configuration	
▶ IPv6 Address	<input type="text"/>
▶ Subnet Prefix Length	<input type="text"/>
▶ Default Gateway	<input type="text"/>
▶ Primary DNS	<input type="text"/>
▶ Secondary DNS	<input type="text"/>
▶ MLD Snooping	<input type="checkbox"/> Enable

Item	Value setting	Description
IPv6 Address	A Must filled setting	Enter the WAN IPv6 Address for the router.
Subnet Prefix	A Must filled setting	Enter the WAN Subnet Prefix Length for the router.

4G IIoT LoRa Gateway

Length		
Default Gateway	A Must filled setting	Enter the WAN Default Gateway IPv6 address.
Primary DNS	An optional setting	Enter the WAN primary DNS Server .
Secondary DNS	An optional setting	Enter the WAN secondary DNS Server .
MLD Snooping	The box is unchecked by default	Enable/Disable the MLD Snooping function

LAN Configuration

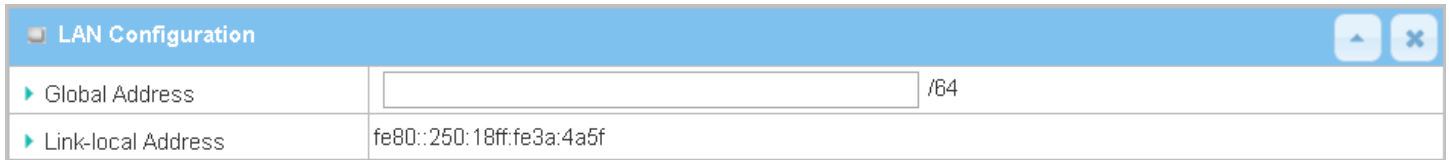

The screenshot shows a window titled "LAN Configuration" with a blue header bar. Below the header, there are two rows of configuration items. The first row is "Global Address" with an empty text input field followed by "/64". The second row is "Link-local Address" with the value "fe80::250:18ff:fe3a:4a5f".

LAN Configuration		
Item	Value setting	Description
Global Address	A Must filled setting	Enter the LAN IPv6 Address for the router.
Link-local Address	Value auto-created	Show the link-local address for LAN interface of router.

Then go to **Address Auto-configuration (summary)** for setting LAN environment.

If above setting is configured, click the **Save** button to save the configuration, and click the **Reboot** button to reboot the router.

4G IIoT LoRa Gateway

DHCPv6 WAN Type Configuration

DHCPv6 WAN Type Configuration	
▶ DNS	<input checked="" type="radio"/> From Server <input type="radio"/> Specific DNS
▶ Primary DNS	<input type="text"/>
▶ Secondary DNS	<input type="text"/>
▶ MLD Snooping	<input type="checkbox"/> Enable

Item	Value setting	Description
DNS	The option [From Server] is selected by default	Select the [Specific DNS] option to active Primary DNS and Secondary DNS. Then fill the DNS information.
Primary DNS	Can not modified by default	Enter the WAN primary DNS Server .
Secondary DNS	Can not modified by default	Enter the WAN secondary DNS Server .
MLD	The box is unchecked by default	Enable/Disable the MLD Snooping function

LAN Configuration

LAN Configuration	
▶ Global Address	<input type="text"/>
▶ Link-local Address	fe80::250:18ff:fe3a:4a5f

Item	Value setting	Description
Global Address	Value auto-created	Enter the LAN IPv6 Address for the router.
Link-local Address	Value auto-created	Show the link-local address for LAN interface of router.

Then go to **Address Auto-configuration (summary)** for setting LAN environment.

If above setting is configured, click the **Save** button to save the configuration, and click **Reboot** button to reboot the router.

4G IIoT LoRa Gateway

PPPoEv6 WAN Type Configuration

PPPoEv6 WAN Type Configuration	
▶ Account	<input type="text" value="admin"/>
▶ Password	<input type="password" value="....."/>
▶ Service Name	<input type="text"/>
▶ Connection Control	Auto-reconnect (Always on)
▶ MTU	<input type="text"/>
▶ MLD Snooping	<input type="checkbox"/> Enable

Item	Value setting	Description
Account	A Must filled setting	Enter the Account for setting up PPPoEv6 connection. If you want more information, please contact your ISP. Value Range: 0 ~ 45 characters.
Password	A Must filled setting	Enter the Password for setting up PPPoEv6 connection. If you want more information, please contact your ISP.
Service Name	A Must filled setting/Option	Enter the Service Name for setting up PPPoEv6 connection. If you want more information, please contact your ISP. Value Range: 0 ~ 45 characters.
Connection Control	Fixed value	The value is Auto-reconnect(Always on) .
MTU	A Must filled setting	Enter the MTU for setting up PPPoEv6 connection. If you want more information, please contact your ISP. Value Range: 1280 ~ 1492.
MLD Snooping	The box is unchecked by default	Enable/Disable the MLD Snooping function

LAN Configuration

LAN Configuration	
▶ Global Address	<input type="text"/>
▶ Link-local Address	fe80::250:18ff:fe3a:4a5f

Item	Value setting	Description
Global Address	Value auto-created	The LAN IPv6 Address for the router.
Link-local Address	Value auto-created	Show the link-local address for LAN interface of router.

Then go to **Address Auto-configuration (summary)** for setting LAN environment.

If above setting is configured, click the **save button** to save the configuration and click **reboot button** to reboot the router.

4G IIoT LoRa Gateway

Then go to **Address Auto-configuration (summary)** for setting LAN environment.
If above setting is configured, click the **save button** to save the configuration and click **reboot button** to reboot the router.

Address Auto-configuration

Address Auto-configuration	
Auto-configuration	<input checked="" type="checkbox"/> Enable
Auto-configuration Type	Stateless ▾
Router Advertisement Lifetime	<input type="text" value="200"/> (seconds)

Address Auto-configuration		
Item	Value setting	Description
Auto-configuration	The box is unchecked by default	Check to enable the Auto configuration feature.
Auto-configuration Type	1. Only can be selected when Auto-configuration enabled 2. Stateless is selected by default	Define the selected IPv6 WAN Connection Type to establish the IPv6 connectivity. Select Stateless to manage the Local Area Network to be SLAAC + RDNSS Router Advertisement Lifetime (A Must filled setting): Enter the Router Advertisement Lifetime (in seconds). 200 is set by default. <i>Value Range:</i> 0 ~ 65535. Select Stateful to manage the Local Area Network to be Stateful (DHCPv6) . IPv6 Address Range (Start) (A Must filled setting): Enter the start IPv6 Address for the DHCPv6 range for your local computers. 0100 is set by default. <i>Value Range:</i> 0001 ~ FFFF. IPv6 Address Range (End) (A Must filled setting): Enter the end IPv6 Address for the DHCPv6 range for your local computers. 0200 is set by default. <i>Value Range:</i> 0001 ~ FFFF. IPv6 Address Lifetime (A Must filled setting): Enter the DHCPv6 lifetime for your local computers. 36000 is set by default. <i>Value Range:</i> 0 ~ 65535.

4G IIoT LoRa Gateway

2.5 Port Forwarding

Network address translation (NAT) is a methodology of remapping one IP address space into another by modifying network address information in Internet Protocol (IP) datagram packet headers while they are in transit across a traffic routing device. The technique was originally used for ease of rerouting traffic in IP networks without renumbering every host. It has become a popular and essential tool in conserving global address space allocations in face of IPv4 address exhaustion. The product you purchased embeds and activates the NAT function. You also can disable the NAT function in **[Basic Network]-[WAN & Uplink]-[Internet Setup]-[WAN Type Configuration]** page.

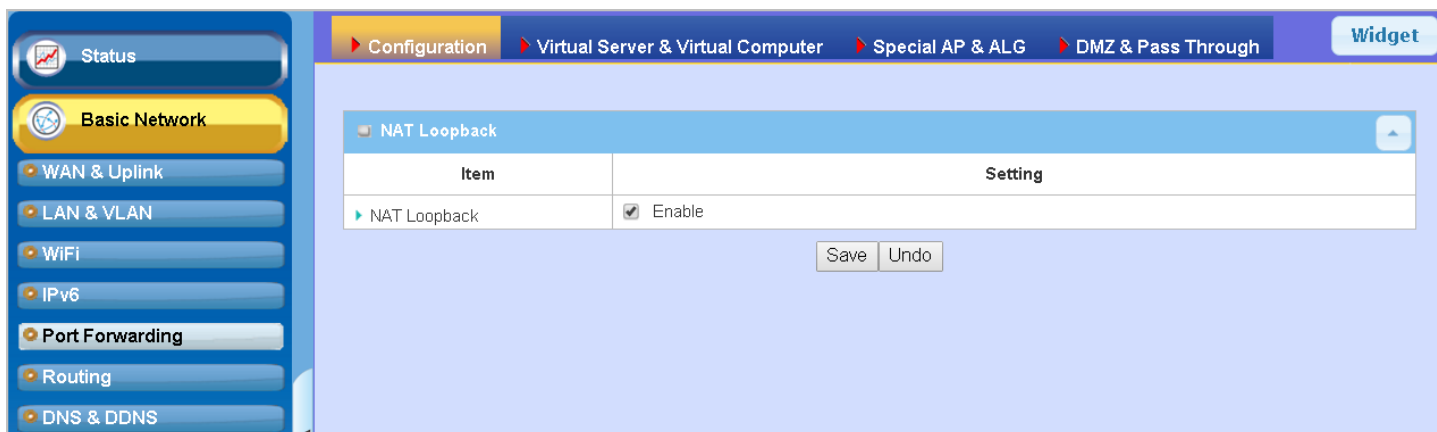

Usually all local hosts or servers behind corporate gateway are protected by NAT firewall. NAT firewall will filter out unrecognized packets to protect your Intranet. So, all local hosts are invisible to the outside world. Port forwarding or port mapping is function that redirects a communication request from one address and port number combination to assigned one. This technique is most commonly used to make services on a host residing on a protected or masqueraded (internal) network available to hosts on the opposite side of the gateway (external network), by remapping the destination IP address and port number

4G IIoT LoRa Gateway

2.5.1 Configuration

NAT Loopback

This feature allows you to access the WAN global IP address from your inside NAT local network. It is useful when you run a server inside your network. For example, if you set a mail server at LAN side, your local devices can access this mail server through gateway's global IP address when enable NAT loopback feature. On either side are you in accessing the email server, at the LAN side or at the WAN side, you don't need to change the IP address of the mail server.

Configuration Setting

Go to **Basic Network > Port Forwarding > Configuration** tab.

The NAT Loopback allows user to access the WAN IP address from inside your local network.

Enable NAT Loopback



The screenshot shows a configuration window titled "NAT Loopback" with a blue header and a close button. Below the header is a table with two columns: "Item" and "Setting". The table contains one row with "NAT Loopback" in the "Item" column and a checked checkbox followed by "Enable" in the "Setting" column.

Item	Setting
▶ NAT Loopback	<input checked="" type="checkbox"/> Enable

Configuration Item	Value setting	Description
NAT Loopback	The box is checked by default	Check the Enable box to activate this NAT function
Save	N/A	Click the Save button to save the settings.
Undo	N/A	Click the Undo button to cancel the settings

4G IIoT LoRa Gateway

2.5.2 Virtual Server & Virtual Computer

Configuration ▲ ✕

Item	Setting
▶ Virtual Server	<input type="checkbox"/> Enable
▶ Virtual Computer	<input checked="" type="checkbox"/> Enable

Virtual Server List Add Delete ▲ ✕

ID	WAN Interface	Server IP	Source IP	Protocol	Public Port	Private Port	Time Schedule	Enable	Actions
----	---------------	-----------	-----------	----------	-------------	--------------	---------------	--------	---------

Virtual Computer List Add Delete ▲ ✕

ID	Global IP	Local IP	Enable	Actions
----	-----------	----------	--------	---------

There are some important Port Forwarding functions implemented within the gateway, including "Virtual Server", "NAT loopback" and "Virtual Computer".

It is necessary for cooperate staffs who travel outside and want to access various servers behind office gateway. You can set up those servers by using "Virtual Server" feature. After trip, if want to access those servers from LAN side by global IP, without change original setting, NAT Loopback can achieve it.

"Virtual computer" is a host behind NAT gateway whose IP address is a global one and is visible to the outside world. Since it is behind NAT, it is protected by gateway firewall. To configure Virtual Computer, you just have to map the local IP of the virtual computer to a global IP.

4G IIoT LoRa Gateway

Virtual Server & NAT Loopback

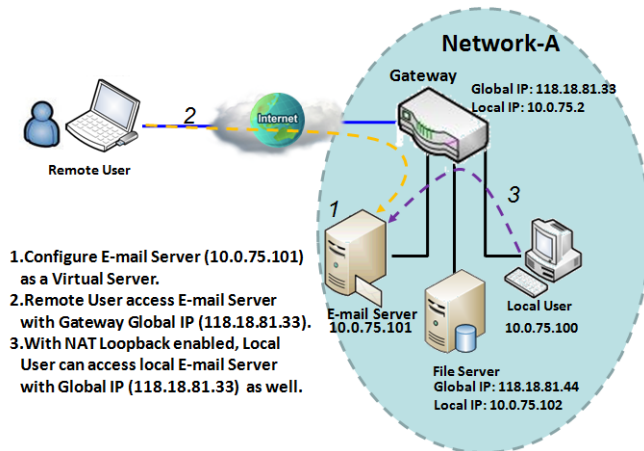

"Virtual Server" allows you to access servers with the global IP address or FQDN of the gateway as if they are servers existed in the Internet. But in fact, these servers are located in the Intranet and are physically behind the gateway. The gateway serves the service requests by port forwarding the requests to the LAN servers and transfers the replies from LAN servers to the requester on the WAN side. As shown in example, an E-mail virtual server is defined to be located at a server with IP address 10.0.75.101 in the Intranet of Network-A, including SMTP service port 25 and POP3 service port 110. So, the remote user can access the E-mail server with the

gateway's global IP 118.18.81.33 from its WAN side. But the real E-mail server is located at LAN side and the gateway is the port forwarder for E-mail service.

NAT Loopback allows you to access the WAN global IP address from your inside NAT local network. It is useful when you run a server inside your network. For example, if you set a mail server at LAN side, your local devices can access this mail server through gateway's global IP address when enable NAT loopback feature. On either side are you in accessing the email server, at the LAN side or at the WAN side, you don't need to change the IP address of the mail server.

Virtual Computer

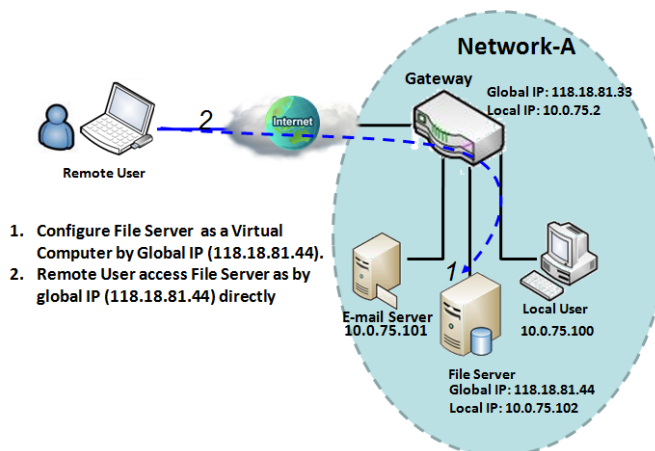

"Virtual Computer" allows you to assign LAN hosts to global IP addresses, so that they can be visible to outside world. While so, they are also protected by the gateway firewall as being client hosts in the Intranet. For example, if you set a FTP file server at LAN side with local IP address 10.0.75.102 and global IP address 118.18.82.44, a remote user can access the file server while it is hidden behind the NAT gateway. That is because the gateway takes care of all accessing to the IP address 118.18.82.44, including to forward the access requests to the file server and to send the replies from the server to outside world.

4G IIoT LoRa Gateway

Virtual Server & Virtual Computer Setting

Go to **Basic Network > Port Forwarding > Virtual Server & Virtual Computer** tab.

Enable Virtual Server and Virtual Computer

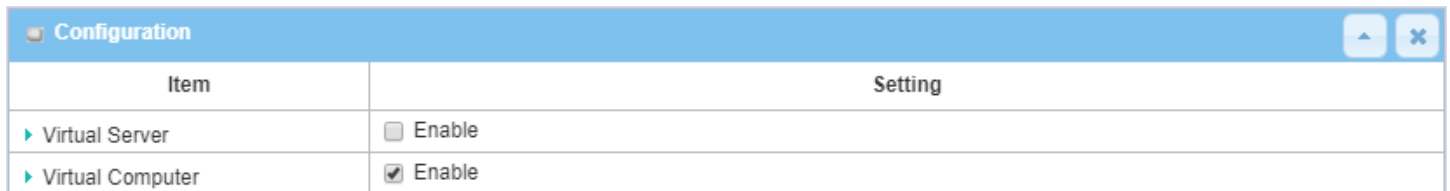

Item	Setting
Virtual Server	<input type="checkbox"/> Enable
Virtual Computer	<input checked="" type="checkbox"/> Enable

Configuration Item	Value setting	Description
Virtual Server	The box is unchecked by default	Check the Enable box to activate this port forwarding function
Virtual Computer	The box is checked by default	Check the Enable box to activate this port forwarding function
Save	N/A	Click the Save button to save the settings.
Undo	N/A	Click the Undo button to cancel the settings.

Create / Edit Virtual Server

The gateway allows you to custom your Virtual Server rules. It supports up to a maximum of 20 rule-based Virtual Server sets.



ID	WAN Interface	Server IP	Source IP	Protocol	Public Port	Private Port	Time Schedule	Enable	Actions
----	---------------	-----------	-----------	----------	-------------	--------------	---------------	--------	---------

When **Add** button is applied, **Virtual Server Rule Configuration** screen will appear.

4G IIoT LoRa Gateway

Virtual Server Rule Configuration	
Item	Setting
▶ WAN Interface	<input checked="" type="checkbox"/> All <input type="checkbox"/> WAN-1 <input type="checkbox"/> WAN-2 <input type="checkbox"/> WAN-3
▶ Server IP	<input type="text"/>
▶ Source IP	Any ▼
▶ Protocol	TCP(6) & UDP(17) ▼
▶ Public Port	Single Port ▼ <input type="text"/>
▶ Private Port	Single Port ▼ <input type="text"/>
▶ Time Schedule	(0) Always ▼
▶ Rule	<input type="checkbox"/> Enable

Virtual Server Rule Configuration		
Item	Value setting	Description
WAN Interface	<ol style="list-style-type: none"> 1. A Must filled setting 2. Default is ALL. 	<p>Define the selected interface to be the packet-entering interface of the gateway.</p> <p>If the packets to be filtered are coming from WAN-x then select WAN-x for this field.</p> <p>Select ALL for packets coming into the gateway from any interface. It can be selected WAN-x box when WAN-x enabled.</p> <p>Note: The available check boxes (WAN-1 ~ WAN-4) depend on the number of WAN interfaces for the product.</p>
Server IP	A Must filled setting	This field is to specify the IP address of the interface selected in the WAN Interface setting above.
Source IP	<ol style="list-style-type: none"> 1. A Must filled setting 2. By default Any is selected 	<p>This field is to specify the Source IP address.</p> <p>Select Any to allow the access coming from any IP addresses.</p> <p>Select Specific IP Address to allow the access coming from an IP address.</p> <p>Select IP Range to allow the access coming from a specified range of IP address.</p>
Protocol	<ol style="list-style-type: none"> 1. A Must filled setting 2. TCP & UDP is selected by default. 	<p>When "ICMPv4" is selected</p> <p>It means the option "Protocol" of packet filter rule is ICMPv4.</p> <p>Apply Time Schedule to this rule, otherwise leave it as Always. (refer to Scheduling setting under Object Definition)</p> <p>Then check Enable box to enable this rule.</p> <p>When "TCP" is selected</p> <p>It means the option "Protocol" of packet filter rule is TCP.</p> <p>Public Port selected a predefined port from Well-known Service, and Private Port is the same with Public Port number.</p> <p>Public Port is selected Single Port and specify a port number, and Private Port can be set a Single Port number.</p> <p>Public Port is selected Port Range and specify a port range, and Private Port can be selected Single Port or Port Range.</p> <p><u>Value Range:</u> 1 ~ 65535 for Public Port, Private Port.</p>

4G IIoT LoRa Gateway

When **“UDP”** is selected
 It means the option “Protocol” of packet filter rule is UDP.
Public Port selected a predefined port from **Well-known Service**, and **Private Port** is the same with **Public Port** number.
Public Port is selected **Single Port** and specify a port number, and **Private Port** can be set a **Single Port** number.
Public Port is selected **Port Range** and specify a port range, and **Private Port** can be selected **Single Port** or **Port Range**.
Value Range: 1 ~ 65535 for Public Port, Private Port.

When **“TCP & UDP”** is selected
 It means the option “Protocol” of packet filter rule is TCP and UDP.
Public Port selected a predefined port from **Well-known Service**, and **Private Port** is the same with **Public Port** number.
Public Port is selected **Single Port** and specify a port number, and **Private Port** can be set a **Single Port** number.
Public Port is selected **Port Range** and specify a port range, and **Private Port** can be selected **Single Port** or **Port Range**.
Value Range: 1 ~ 65535 for Public Port, Private Port.

When **“GRE”** is selected
 It means the option “Protocol” of packet filter rule is GRE.

When **“ESP”** is selected
 It means the option “Protocol” of packet filter rule is ESP.

When **“SCTP”** is selected
 It means the option “Protocol” of packet filter rule is SCTP.

When **“User-defined”** is selected
 It means the option “Protocol” of packet filter rule is User-defined.
 For **Protocol Number**, enter a port number.

Time Schedule	1. An optional filled setting 2. (0) Always Is selected by default.	Apply Time Schedule to this rule; otherwise leave it as (0) Always. (refer to Scheduling setting under Object Definition)
Rule	1. An optional filled setting 2. The box is unchecked by default.	Check the Enable box to activate the rule.
Save	N/A	Click the Save button to save the settings.
Undo	N/A	Click the X button to cancel the settings and return to previous page.

4G IIoT LoRa Gateway

Create / Edit Virtual Computer

The gateway allows you to custom your Virtual Computer rules. It supports up to a maximum of 20 rule-based Virtual Computer sets.

Virtual Computer List				
ID	Global IP	Local IP	Enable	Actions

When **Add** button is applied, **Virtual Computer Rule Configuration** screen will appear.

Virtual Computer Rule Configuration		
Global IP	Local IP	Enable
<input type="text"/>	<input type="text"/>	<input type="checkbox"/>

Virtual Computer Rule Configuration		
Item	Value setting	Description
Global IP	A Must filled setting	This field is to specify the IP address of the WAN IP.
Local IP	A Must filled setting	This field is to specify the IP address of the LAN IP.
Enable	N/A	Then check Enable box to enable this rule.
Save	N/A	Click the Save button to save the settings.

4G IIoT LoRa Gateway

2.5.3 DMZ & Pass Through

DMZ (De Militarized Zone) Host is a host that is exposed to the Internet cyberspace but still within the protection of firewall by gateway device. So, the function allows a computer to execute 2-way communication for Internet games, Video conferencing, Internet telephony and other special applications. In some cases when a specific application is blocked by NAT mechanism, you can indicate that LAN computer as a DMZ host to solve this problem.

The DMZ function allows you to ask the gateway pass through all normal packets to the DMZ host behind the NAT gateway only when these packets are not expected to receive by applications in the gateway or by other client hosts in the Intranet. Certainly, the DMZ host is also protected by the gateway firewall. Activate the feature and specify the DMZ host with a host in the Intranet when needed.

Configuration	
Item	Setting
DMZ	<input checked="" type="checkbox"/> Enable <input checked="" type="checkbox"/> All <input type="checkbox"/> WAN-1 <input type="checkbox"/> WAN-2 <input type="checkbox"/> WAN-3 <input type="checkbox"/> WAN-4 DMZ Host: <input type="text" value="10.0.75.100"/>
Pass Through Enable	<input checked="" type="checkbox"/> IPSec <input checked="" type="checkbox"/> PPTP <input checked="" type="checkbox"/> L2TP

DMZ Scenario

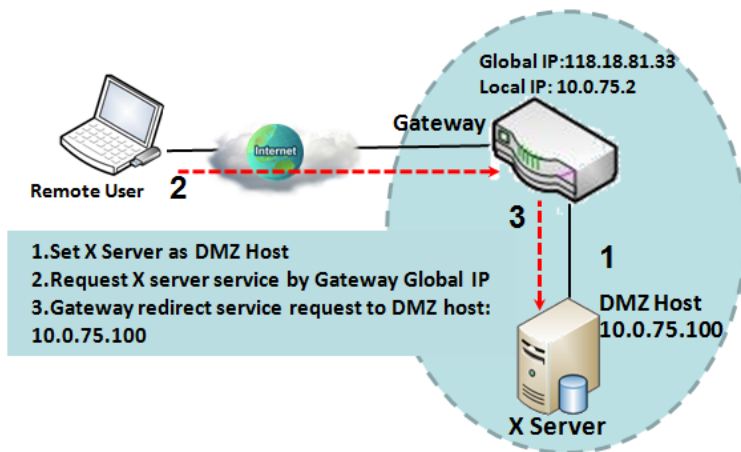

When the network administrator wants to set up some service daemons in a host behind NAT gateway to allow remote users request for services from server actively, you just have to configure this host as DMZ Host. As shown in the diagram, there is an X server installed as DMZ host, whose IP address is 10.0.75.100. Then, remote user can request services from X server just as it is provided by the gateway whose global IP address is 118.18.81.33. The gateway will forward those packets, not belonging to any configured virtual server or applications, directly to the DMZ host.

4G IIoT LoRa Gateway

VPN Pass through Scenario

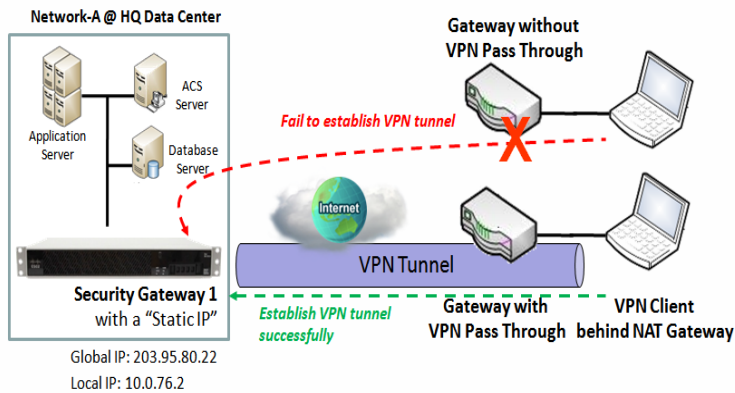

Since VPN traffic is different from that of TCP or UDP connection, it will be blocked by NAT gateway. To support the pass through function for the VPN connections initiating from VPN clients behind NAT gateway, the gateway must implement some kind of VPN pass through function for such application. The gateway support the pass through function for IPSec, PPTP, and L2TP connections, you just have to check the corresponding checkbox to activate it.

DMZ & Pass Through Setting

Go to **Basic Network > Port Forwarding > DMZ & Pass Through** tab.

The DMZ host is a host that is exposed to the Internet cyberspace but still within the protection of firewall by gateway device.

Enable DMZ and Pass Through

Configuration	
Item	Setting
DMZ	<input type="checkbox"/> Enable <input checked="" type="checkbox"/> All <input type="checkbox"/> WAN-1 <input type="checkbox"/> WAN-2 <input type="checkbox"/> WAN-3 <input type="checkbox"/> WAN-4 DMZ Host: <input type="text"/>
Pass Through Enable	<input checked="" type="checkbox"/> IPSec <input checked="" type="checkbox"/> PPTP <input checked="" type="checkbox"/> L2TP

Configuration Item	Value setting	Description
DMZ	1. A Must filled setting 2. Default is ALL .	Check the Enable box to activate the DMZ function Define the selected interface to be the packet-entering interface of the gateway, and fill in the IP address of Host LAN IP in DMZ Host field . If the packets to be filtered are coming from WAN-x then select WAN-x for this field. Select ALL for packets coming into the router from any interfaces. It can be selected WAN-x box when WAN-x enabled.

4G IIoT LoRa Gateway

		Note: The available check boxes (WAN-1 ~ WAN-4) depend on the number of WAN interfaces for the product.
Pass Through Enable	The boxes are checked by default	Check the box to enable the pass through function for the IPSec , PPTP , and L2TP . With the pass through function enabled, the VPN hosts behind the gateway still can connect to remote VPN servers.
Save	N/A	Click the Save button to save the settings.
Undo	N/A	Click the Undo button to cancel the settings

4G IIoT LoRa Gateway

2.5.4 Special AP & ALG

As a NAT gateway, it doesn't allow an active connection request from outside world. All this kind of requests will be ignored by the NAT gateway. But at the client hosts in the Intranet, users may use applications that need more service ports to be allowed for passing through the NAT gateway. The "Special AP (application)" feature in the gateway can solve this problem. That is, some applications require multiple connections, like Internet games, Video conferencing, Internet telephony, etc. Because of the firewall function, these applications cannot work with a pure NAT gateway. The Special AP feature allows some of these applications to work with this product.

Besides, application-level gateway (ALG) allows customized NAT traversal filters to be plugged into the gateway to support address and port translation for certain application layer "control/data" protocols such as FTP, BitTorrent, SIP, RTSP, file transfer in IM applications, etc. In order for these protocols to work through NAT or a firewall, either the application has to know about an address/port number combination that allows incoming packets, or the NAT has to monitor the control traffic and open up port mappings (firewall pinhole) dynamically as required. Legitimate application data can thus be passed through the security checks of the firewall or NAT that would have otherwise restricted the traffic for not meeting its limited filter criteria.

Special AP

ID	WAN Interface	Trigger Port	Incoming Ports	Time Schedule	Enable	Actions
1	ALL	554	6970-6999	(0) Always	<input checked="" type="checkbox"/>	Edit <input type="checkbox"/> Select
2	ALL	47624	2300-2400,28800-29000	(0) Always	<input checked="" type="checkbox"/>	Edit <input type="checkbox"/> Select

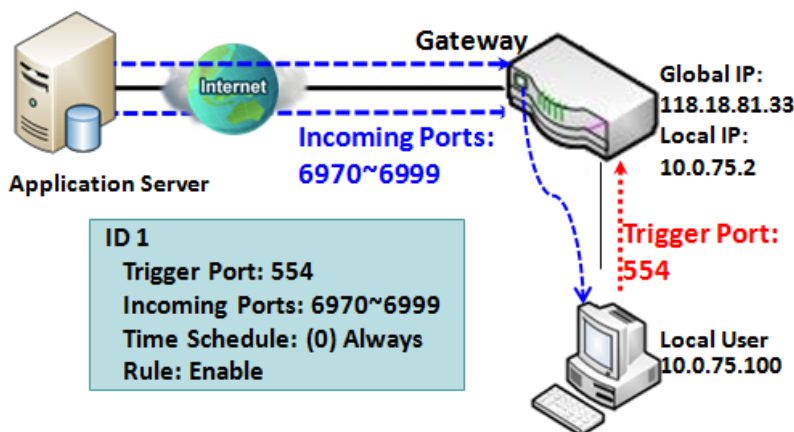

The Special AP feature allows you to request the gateway open a pre-defined service ports for incoming packets to pass through once the trigger port is activated by local hosts. As shown in the diagram, special AP rule define port **554** as trigger port and **6970~6999** as incoming ports. With such setting, local user at host 10.0.75.100 can enjoy the music by using Quick Time application, whose media server is located in the Internet. When you open application, it will activate Trigger Port and then incoming

data packet from remote application server will pass through incoming port 6970~6999.

4G IIoT LoRa Gateway

SIP ALG

This gateway supports the SIP ALG feature to allow one SIP phone behind the NAT gateway can call another SIP phone in the Internet, even the gateway executes its NAT mechanism between the Intranet and the Internet. The NAT gateway monitors the control traffic and open up port mappings (firewall pinhole) dynamically as required to know about an address/port number combination that allows incoming packets, so it will support address and port translation for SIP application layer "control/data" protocols as shown in following diagram. The NAT Gateway enables the SIP ALG feature, so it will monitor the SIP Phone #1 actions, open up the required ports and make the address and port translation in a SIP voice communication.

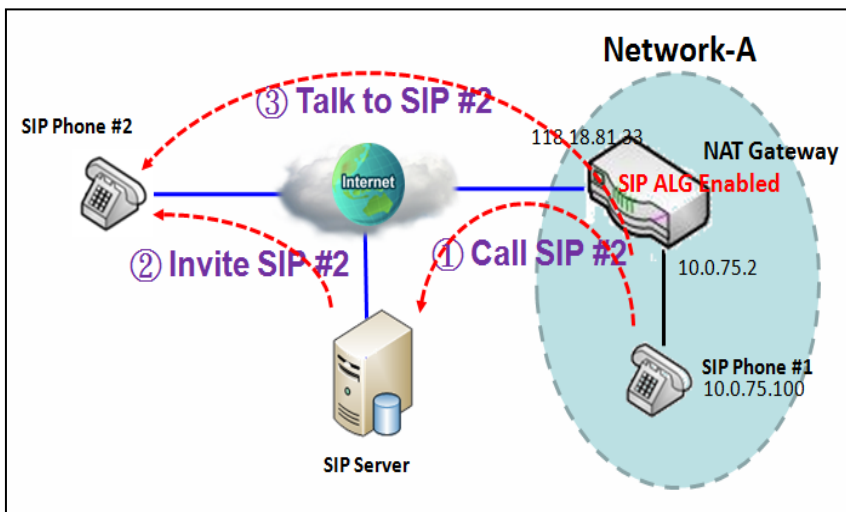

As shown in the diagram, the calling starts from the SIP Phone #1 to the SIP server via the NAT gateway. Then the SIP server invites the SIP Phone #2 and finally, the SIP Phone #1 talks to the SIP Phone #2. But for the NAT gateway, SIP Phone #2 is an unknown host, so the active access from the Phone #2 will be treated as unexpected traffic and will be blocked out. With the SIP ALG function enabled, the NAT gateway will monitor the control traffic for the SIP calls, and recognized the traffic from SIP Phone #2 is part of the connection sessions with SIP Phone #1.

4G IIoT LoRa Gateway

Special AP & ALG Setting

Go to **Basic Network > Port Forwarding > Special AP & ALG** tab.

The Special AP setting allows some applications require multiple connections. The ALG setting allows user to Support some SIP ALG, like STUN.

Enable Special AP & ALG

Configuration	
Item	Setting
▶ Special AP	<input checked="" type="checkbox"/> Enable
▶ ALG Enable	<input checked="" type="checkbox"/> SIP ALG

Configuration Item	Value setting	Description
Special AP	The box is checked by default	Check the Enable box to activate the Special AP function.
ALG Enable	The box is checked by default	Check the Enable box to activate the SIP ALG function.
Save	N/A	Click the Save button to save the settings.
Undo	N/A	Click the Undo button to cancel the settings

Create / Edit Special AP Rule

The gateway allows you to custom your Special AP rules. It supports up to a maximum of 8 rule-based Special AP sets.

Special AP List						
ID	WAN Interface	Trigger Port	Incoming Ports	Time Schedule	Enable	Actions

When **Add** button is applied, **Special AP Rule Configuration** screen will appear.

4G IIoT LoRa Gateway

Special AP Rule Configuration
⬆️ ✕

Item	Setting
▶ WAN Interface	<input checked="" type="checkbox"/> ALL <input type="checkbox"/> WAN-1 <input type="checkbox"/> WAN-2 <input type="checkbox"/> WAN-3 <input type="checkbox"/> WAN-4
▶ Trigger Port	Port : <input type="text"/> Popular Applications : <input type="text" value="User-defined"/> ▼
▶ Incoming Ports	<input type="text"/>
▶ Time Schedule	<input type="text" value="(0) Always"/> ▼
▶ Rule	<input type="checkbox"/>

IP Translation Configuration		
Item	Value setting	Description
WAN Interface	1. A Must filled setting 2. All is checked by default.	Check the interface box(es) to apply the Special AP rule. By default, All is checked, and the Special AP rule will be applied to all WAN interfaces.
Trigger Port	1. A Must filled setting 2. User-defined is selected by default.	Enter the expected trigger port (or port range) if User-defined is selected in the dropdown list. If you select other popular application from the dropdown list, the corresponding trigger port(s) and incoming ports will be defined automatically. Value Range: 1 ~ 65535.
Incoming Ports	1. A Must filled setting	Enter the expected Incoming ports if User-defined is selected in the Trigger Port dropdown list. If you select other popular application from the dropdown list, the corresponding incoming ports will be defined automatically. Value Range: 1 ~ 65535; It can be a single port, multiple ports separated by “,” .or port range.
Time Schedule	1. An Must filled setting 2. (0) Always is selected by default.	Apply Time Schedule to this rule, otherwise leave it as Always. If the dropdown list is empty ensure Time Schedule is pre-configured. Refer to Object Definition > Scheduling > Configuration tab.
Rule	The box is unchecked by default	Check the Enable box to activate the special AP rule.
Save	N/A	Click the Save button to save the settings.
Undo	N/A	Click the Undo button to cancel the settings

2.6 Routing

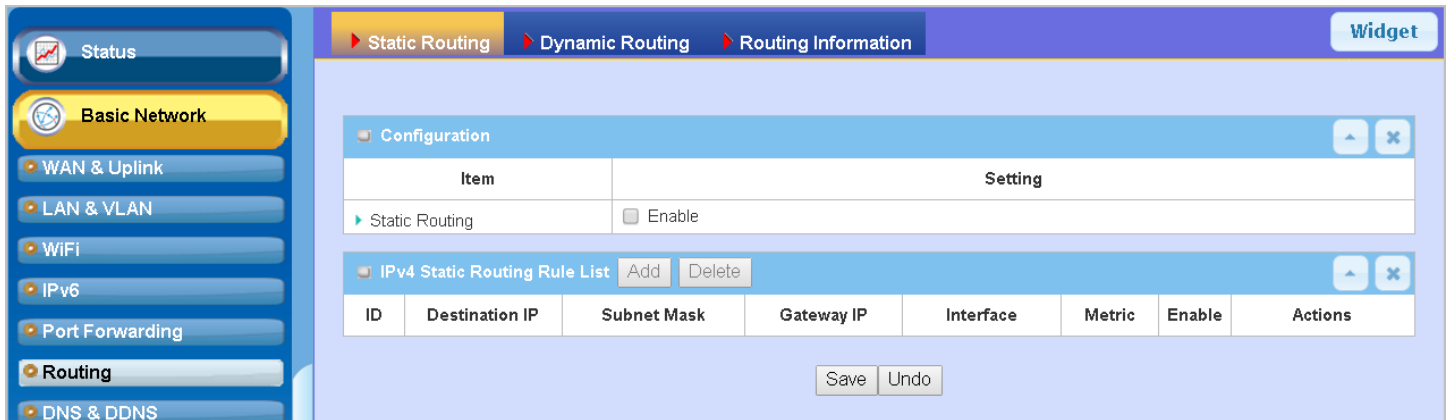

If you have more than one router and subnet, you will need to enable routing function to allow packets to find proper routing path and allow different subnets to communicate with each other. Routing is the process of selecting best paths in a network. It is performed for many kinds of networks, like electronic data networks (such as the Internet), by using packet switching technology. The routing process usually directs forwarding on the basis of routing tables which maintain a record of the routes to various network destinations. Thus, constructing routing tables, which are held in the router's memory, is very important for efficient routing. Most routing algorithms use only one network path at a time.

The routing tables record your pre-defined routing paths for some specific destination subnets. It is **static routing**. However, if the contents of routing tables record the obtained routing paths from neighbor routers by using some protocols, such as RIP, OSPF and BGP. It is **dynamic routing**. These both routing approaches will be illustrated one after one. In addition, the gateway also built in one advanced configurable routing software Quagga for more complex routing applications, you can configure it if required via Telnet CLI.

4G IIoT LoRa Gateway

2.6.1 Static Routing

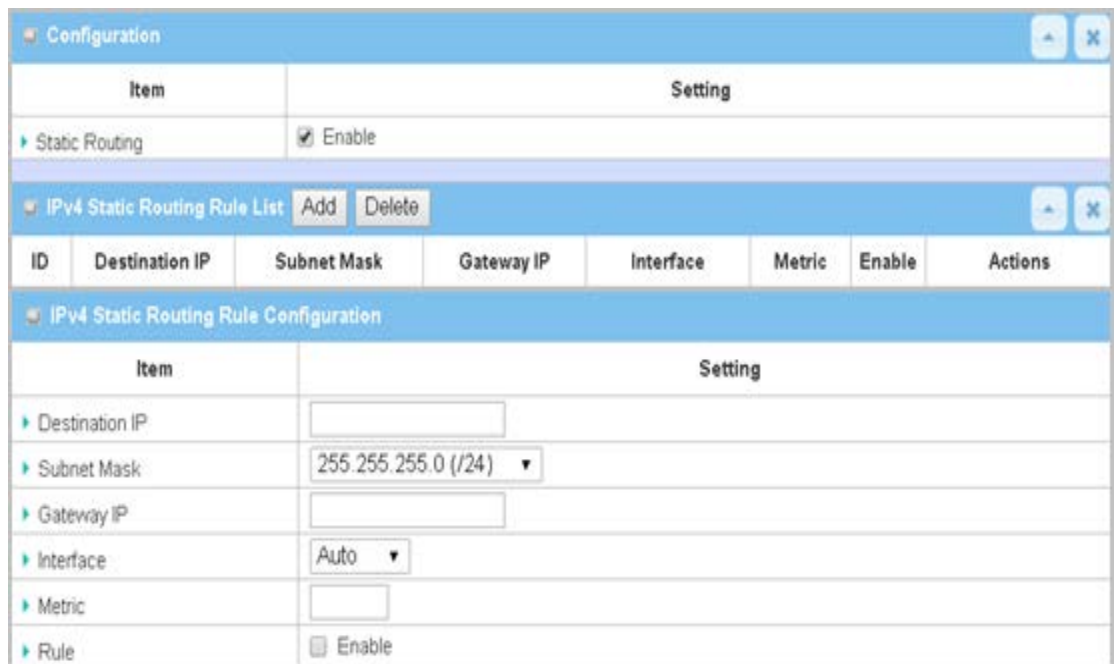
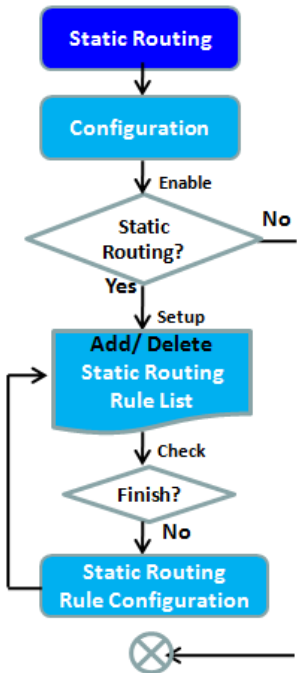

"Static Routing" function lets you define the routing paths for some dedicated hosts/servers or subnets to store in the routing table of the gateway. The gateway routes incoming packets to different peer gateways based on the routing table. You need to define the static routing information in gateway routing rule list.

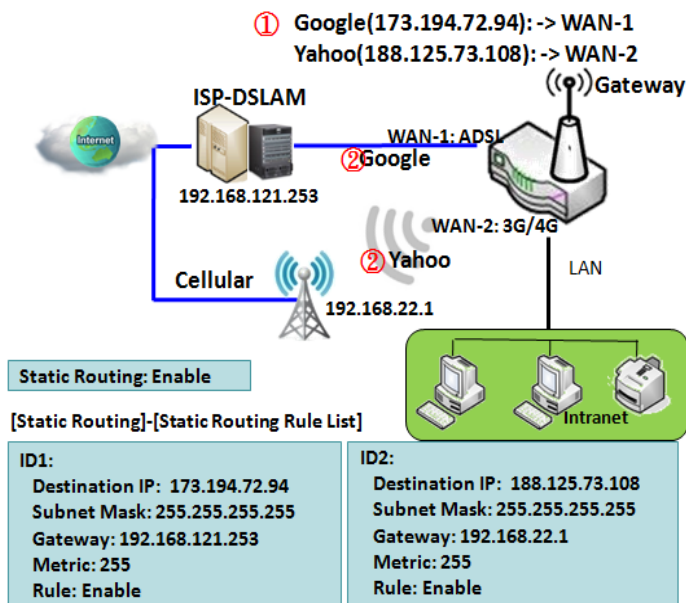

When the administrator of the gateway wants to specify what kinds of packets to be transferred via which gateway interface and which peer gateway to their destination. It can be carried out by the "Static Routing" feature. Dedicated packet flows from the Intranet will be routed to their destination via the pre-defined peer gateway and corresponding gateway interface that are defined in the system routing table by manual.

As shown in the diagram, when the destination is Google access, rule 1 set interface as ADSL, routing gateway as IP-DSLAM gateway 192.168.121.253. All the packets to Google will go through WAN-1. And the same way applied to rule 2 of access Yahoo. Rule 2 sets 3G/4G as interface.

4G IIoT LoRa Gateway

Static Routing Setting

Go to **Basic Network > Routing > Static Routing** Tab.

There are three configuration windows for static routing feature, including "Configuration", "Static Routing Rule List" and "Static Routing Rule Configuration" windows. "Configuration" window lets you activate the global static routing feature. Even there are already routing rules, if you want to disable routing temporarily, just uncheck the Enable box to disable it. "Static Routing Rule List" window lists all your defined static routing rule entries. Using "Add" or "Edit" button to add and create one new static routing rule or to modify an existed one.

When "**Add**" or "**Edit**" button is applied, the "Static Routing Rule Configuration" window will appear to let you define a static routing rule.

Enable Static Routing

Just check the **Enable** box to activate the "Static Routing" feature.



Item	Setting
▶ Static Routing	<input checked="" type="checkbox"/> Enable

Static Routing Item	Value setting	Description
Static Routing	The box is unchecked by default	Check the Enable box to activate this function

Create / Edit Static Routing Rules

The Static Routing Rule List shows the setup parameters of all static routing rule entries. To configure a static routing rule, you must specify related parameters including the destination IP address and subnet mask of dedicated host/server or subnet, the IP address of peer gateway, the metric and the rule activation.



ID	Destination IP	Subnet Mask	Gateway IP	Interface	Metric	Enable	Actions
----	----------------	-------------	------------	-----------	--------	--------	---------

The gateway allows you to custom your static routing rules. It supports up to a maximum of 64 rule sets. When **Add** button is applied, **Static Routing Rule Configuration** screen will appear, while the **Edit** button at the end

4G IIoT LoRa Gateway

of each static routing rule can let you modify the rule.

IPv4 Static Routing Rule Configuration	
Item	Setting
▶ Destination IP	<input type="text"/>
▶ Subnet Mask	255.255.255.0 (/24) ▼
▶ Gateway IP	<input type="text"/>
▶ Interface	Auto ▼
▶ Metric	<input type="text"/>
▶ Rule	<input type="checkbox"/> Enable

IPv4 Static Routing		
Item	Value setting	Description
Destination IP	1. IPv4 Format 2. A Must filled setting	Specify the Destination IP of this static routing rule.
Subnet Mask	255.255.255.0 (/24) is set by default	Specify the Subnet Mask of this static routing rule.
Gateway IP	1. IPv4 Format 2. A Must filled setting	Specify the Gateway IP of this static routing rule.
Interface	Auto is set by default	Select the Interface of this static routing rule. It can be Auto , or the available WAN / LAN interfaces.
Metric	1. Numeric String Format 2. A Must filled setting	The Metric of this static routing rule. <i>Value Range: 0 ~ 255.</i>
Rule	The box is unchecked by default.	Click Enable box to activate this rule.
Save	NA	Click the Save button to save the configuration
Undo	NA	Click the Undo button to restore what you just configured back to the previous setting.
Back	NA	When the Back button is clicked the screen will return to the Static Routing Configuration page.

4G IIoT LoRa Gateway

2.6.2 Dynamic Routing

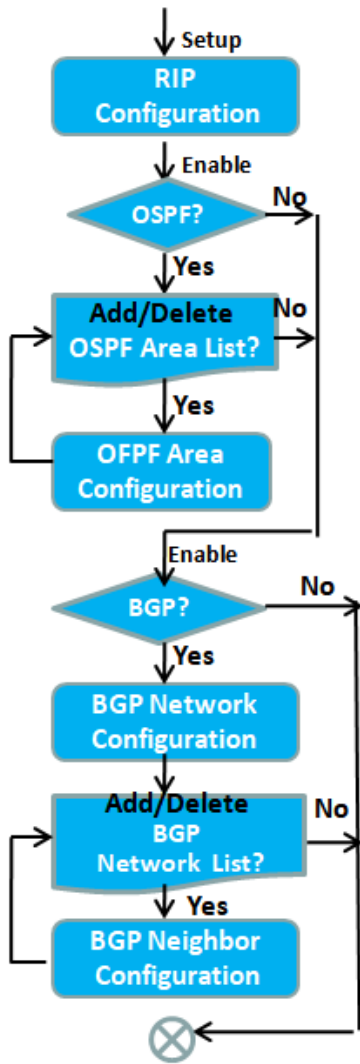

RIP Configuration	
Item	Setting
▶ RIP Enable	Disable

OSPF Configuration	
Item	Setting
▶ OSPF	<input type="checkbox"/> Enable
▶ Router ID	
▶ Authentication	None
▶ Backbone Subnet	

OSPF Area List				
ID	Area Subnet	Area ID	Enable	Actions

OSPF Area Configuration	
Item	Setting
▶ Area Subnet	
▶ Area ID	
▶ Area	<input type="checkbox"/> Enable

BGP Configuration	
Item	Setting
▶ BGP	<input type="checkbox"/> Enable
▶ ASN	
▶ Router ID	

BGP Network List			
ID	Network Subnet	Enable	Actions

BGP Neighbor List				
ID	Neighbor IP	Remote ASN	Enable	Actions

Dynamic Routing, also called adaptive routing, describes the capability of a system, through which routes are characterized by their destination, to alter the path that the route takes through the system in response to a change in network conditions.

This gateway supports dynamic routing protocols, including RIPv1/RIPv2 (Routing Information Protocol), OSPF (Open Shortest Path First), and BGP (Border Gateway Protocol), for you to establish routing table automatically. The feature of dynamic routing will be very useful when there are lots of subnets in your network. Generally speaking, RIP is suitable for small network. OSPF is more suitable for medium network. BGP is more used for big network infrastructure.

The supported dynamic routing protocols are described as follows.

4G IIoT LoRa Gateway

RIP Scenario

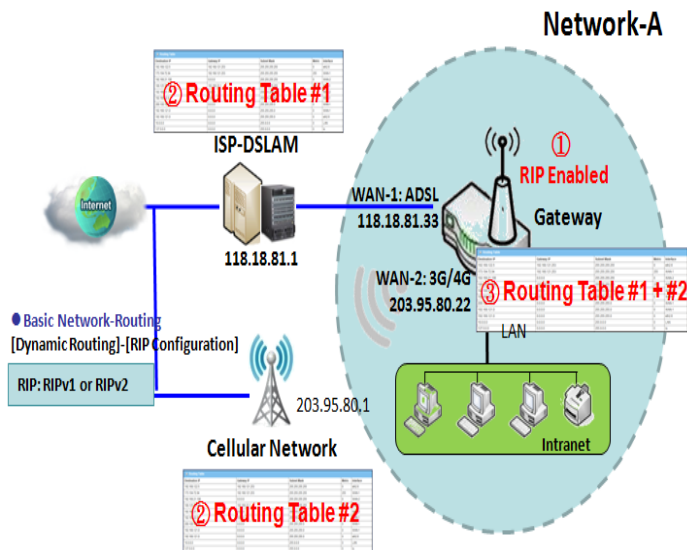

The Routing Information Protocol (RIP) is one of the oldest distance-vector routing protocols, which employs the hop count as a routing metric. RIP prevents routing loops by implementing a limit on the number of hops allowed in a path from the source to a destination. The maximum number of hops allowed for RIP is 15. This hop limit, however, also limits the size of networks that RIP can support. A hop count of 16 is considered an infinite distance, in other words the route is considered unreachable. RIP implements the split horizon, route poisoning and hold-down mechanisms to prevent incorrect routing information from being propagated.

OSPF Scenario

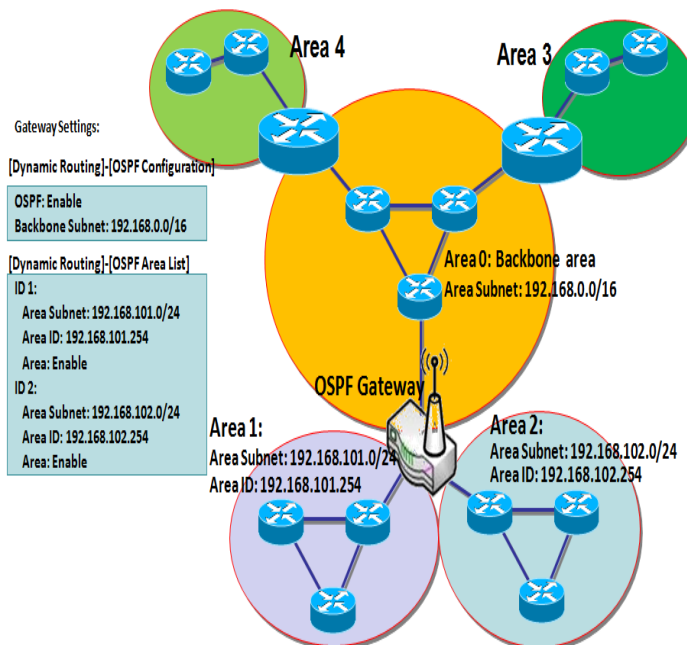

Open Shortest Path First (OSPF) is a routing protocol that uses link state routing algorithm. It is the most widely used interior gateway protocol (IGP) in large enterprise networks. It gathers link state information from available routers and constructs a topology map of the network. The topology is presented as a routing table which routes datagrams based solely on the destination IP address.

Network administrator can deploy OSPF gateway in large enterprise network to get its routing table from the enterprise backbone, and forward routing information to other routers, which are no linked to the enterprise backbone. Usually, an OSPF network is subdivided into routing areas to simplify administration and optimize traffic and resource utilization.

As shown in the diagram, OSPF gateway gathers routing information from the backbone gateways in area 0, and will forward its routing information to the routers in area 1 and area 2 which are not in the backbone.

4G IIoT LoRa Gateway

BGP Scenario

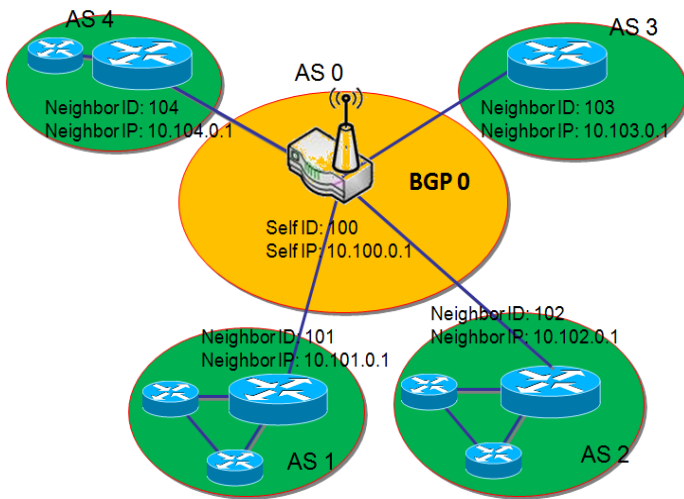

Border Gateway Protocol (BGP) is a standard exterior gateway protocol designed to exchange routing and reachability information between autonomous systems (AS) on the Internet. It usually makes routing decisions based on paths, network policies, or rule-sets.

Most ISPs use BGP to establish routing between one another (especially for multi-homed). Very large private IP networks also use BGP internally. The major BGP gateway within one AS will link with some other border gateways for exchanging routing information. It will distribute the collected data in AS to all routers in other AS.

As shown in the diagram, BGP 0 is gateway to dominate AS 0 (self IP is 10.100.0.1 and self ID is 100). It links with other BGP gateways in the Internet. The scenario is like Subnet in one ISP to be linked with the ones in other ISPs. By operating with BGP protocol, BGP 0 can gather routing information from other BGP gateways in the Internet. And then it forwards the routing data to the routers in its dominated AS. Finally, the routers resided in AS 0 know how to route packets to other AS.

4G IIoT LoRa Gateway

Dynamic Routing Setting

Go to **Basic Network > Routing > Dynamic Routing** Tab.

The dynamic routing setting allows user to customize RIP, OSPF, and BGP protocol through the router based on their office setting.

In the "Dynamic Routing" page, there are several configuration windows for dynamic routing feature. They are the "RIP Configuration" window, "OSPF Configuration" window, "OSPF Area List", "OSPF Area Configuration", "BGP Configuration", "BGP Neighbor List" and "BGP Neighbor Configuration" window. RIP, OSPF and BGP protocols can be configured individually.

The "RIP Configuration" window lets you choose which version of RIP protocol to be activated or disable it. The "OSPF Configuration" window can let you activate the OSPF dynamic routing protocol and specify its backbone subnet. Moreover, the "OSPF Area List" window lists all defined areas in the OSPF network. However, the "BGP Configuration" window can let you activate the BGP dynamic routing protocol and specify its self ID. The "BGP Neighbor List" window lists all defined neighbors in the BGP network.

RIP Configuration

The RIP configuration setting allows user to customize RIP protocol through the router based on their office setting.



Item	Setting
▶ RIP Enable	Disable ▾

RIP Configuration		
Item	Value setting	Description
RIP Enable	Disable is set by default	Select Disable will disable RIP protocol. Select RIP v1 will enable RIPv1 protocol. Select RIP v2 will enable RIPv2 protocol.

OSPF Configuration

The OSPF configuration setting allows user to customize OSPF protocol through the router based on their office setting.

4G IIoT LoRa Gateway

OSPF Configuration	
Item	Setting
▶ OSPF	<input type="checkbox"/> Enable
▶ Router ID	<input type="text"/>
▶ Authentication	None ▾
▶ Backbone Subnet	<input type="text"/>

OSPF Configuration		
Item	Value setting	Description
OSPF	Disable is set by default	Click Enable box to activate the OSPF protocol.
Router ID	1. IPv4 Format 2. A Must filled setting	The Router ID of this router on OSPF protocol
Authentication	None is set by default	The Authentication method of this router on OSPF protocol. Select None will disable Authentication on OSPF protocol. Select Text will enable Text Authentication with entered the Key in this field on OSPF protocol. Select MD5 will enable MD5 Authentication with entered the ID and Key in these fields on OSPF protocol.
Backbone Subnet	1. Classless Inter Domain Routing (CIDR) Subnet Mask Notation. (Ex: 192.168.1.0/24) 2. A Must filled setting	The Backbone Subnet of this router on OSPF protocol.

Create / Edit OSPF Area Rules

The gateway allows you to custom your OSPF Area List rules. It supports up to a maximum of 32 rule sets.

OSPF Area List Add Delete				
ID	Area Subnet	Area ID	Enable	Actions

When **Add** button is applied, **OSPF Area Rule Configuration** screen will appear.

4G IIoT LoRa Gateway

☐ OSPF Area Configuration
⬆️ ✖️

Item	Setting
▶ Area Subnet	<input type="text"/>
▶ Area ID	<input type="text"/>
▶ Area	<input type="checkbox"/> Enable

OSPF Area Configuration		
Item	Value setting	Description
Area Subnet	1. Classless Inter Domain Routing (CIDR) Subnet Mask Notation. (Ex: 192.168.1.0/24) 2. A Must filled setting	The Area Subnet of this router on OSPF Area List.
Area ID	1. IPv4 Format 2. A Must filled setting	The Area ID of this router on OSPF Area List.
Area	The box is unchecked by default.	Click Enable box to activate this rule.
Save	N/A	Click the Save button to save the configuration

4G IIoT LoRa Gateway

BGP Configuration

The BGP configuration setting allows user to customize BGP protocol through the router setting.

BGP Configuration ▲ ✕

Item	Setting
▶ BGP	<input type="checkbox"/> Enable
▶ ASN	<input type="text"/>
▶ Router ID	<input type="text"/>

Item	Value setting	Description
BGP	The box is unchecked by default	Check the Enable box to activate the BGP protocol.
ASN	1. Numeric String Format 2. A Must filled setting	The ASN Number of this router on BGP protocol. Value Range: 1 ~ 4294967295.
Router ID	1. IPv4 Format 2. A Must filled setting	The Router ID of this router on BGP protocol.

Create / Edit BGP Network Rules

The gateway allows you to custom your BGP Network rules. It supports up to a maximum of 32 rule sets.

BGP Network List Add Delete ▲

ID	Network Subnet	Enable	Actions
----	----------------	--------	---------

When **Add** button is applied, **BGP Network Configuration** screen will appear.

BGP Network Configuration ▲ ✕

Item	Setting
▶ Network Subnet	IP : <input type="text"/> <input type="text" value="255.255.255.0 (/24)"/>
▶ Network	<input type="checkbox"/> Enable

Save

Item	Value setting	Description
Network Subnet	1. IPv4 Format	The Network Subnet of this router on BGP Network List. It composes of entered

4G IIoT LoRa Gateway

	2. A Must filled setting	the IP address in this field and the selected subnet mask.
Network	The box is unchecked by default.	Click Enable box to activate this rule.
Save	N/A	Click the Save button to save the configuration

Create / Edit BGP Neighbor Rules

The gateway allows you to custom your BGP Neighbor rules. It supports up to a maximum of 32 rule sets.

BGP Neighbor List
Add
Delete
▲

ID	Neighbor IP	Remote ASN	Enable	Actions
----	-------------	------------	--------	---------

When **Add** button is applied, **BGP Neighbor Configuration** screen will appear.

BGP Neighbor Configuration
▲ ✕

Item	Setting
▶ Neighbor IP	<input style="width: 100%;" type="text"/>
▶ Remote ASN	<input style="width: 100%;" type="text"/>
▶ Neighbor	<input type="checkbox"/> Enable

Save

BGP Neighbor Configuration		
Item	Value setting	Description
Neighbor IP	1. IPv4 Format 2. A Must filled setting	The Neighbor IP of this router on BGP Neighbor List.
Remote ASN	1. Numeric String Format 2. A Must filled setting	The Remote ASN of this router on BGP Neighbor List. <i>Value Range:</i> 1 ~ 4294967295.
Neighbor	The box is unchecked by default.	Click Enable box to activate this rule.
Save	N/A	Click the Save button to save the configuration

4G IIoT LoRa Gateway

2.6.3 Routing Information

The routing information allows user to view the routing table and policy routing information. Policy Routing Information is only available when the Load Balance function is enabled and the Load Balance Strategy is By User Policy.

Go to **Basic Network > Routing > Routing Information Tab.**

Routing Table				
Destination IP	Subnet Mask	Gateway IP	Metric	Interface
100.105.167.72	255.255.255.252	0.0.0.0	0	WAN-2
192.168.66.0	255.255.255.0	0.0.0.0	0	LAN
192.168.127.0	255.255.255.0	0.0.0.0	0	WAN-1
169.254.0.0	255.255.0.0	0.0.0.0	0	LAN
127.0.0.0	255.0.0.0	0.0.0.0	0	lo

Routing Table		
Item	Value setting	Description
Destination IP	N/A	Routing record of Destination IP. IPv4 Format.
Subnet Mask	N/A	Routing record of Subnet Mask. IPv4 Format.
Gateway IP	N/A	Routing record of Gateway IP. IPv4 Format.
Metric	N/A	Routing record of Metric. Numeric String Format.
Interface	N/A	Routing record of Interface Type. String Format.

Policy Routing Information				
Policy Routing Source	Source IP	Destination IP	Destination Port	WAN Interface
Load Balance	-	-	-	-

Policy Routing Information		
Item	Value setting	Description
Policy Routing Source	N/A	Policy Routing of Source. String Format.
Source IP	N/A	Policy Routing of Source IP. IPv4 Format.
Destination IP	N/A	Policy Routing of Destination IP. IPv4 Format.
Destination Port	N/A	Policy Routing of Destination Port. String Format.
WAN Interface	N/A	Policy Routing of WAN Interface. String Format.

4G IIoT LoRa Gateway

2.7 DNS & DDNS

How does user access your server if your WAN IP address changes all the time? One way is to register a new domain name, and maintain your own DNS server. Another simpler way is to apply a domain name to a third-party DDNS service provider. The service can be free or charged. If you want to understand the basic concepts of DNS and Dynamic DNS, you can refer to Wikipedia website^{7,8}.

2.7.1 DNS & DDNS Configuration

Dynamic DNS

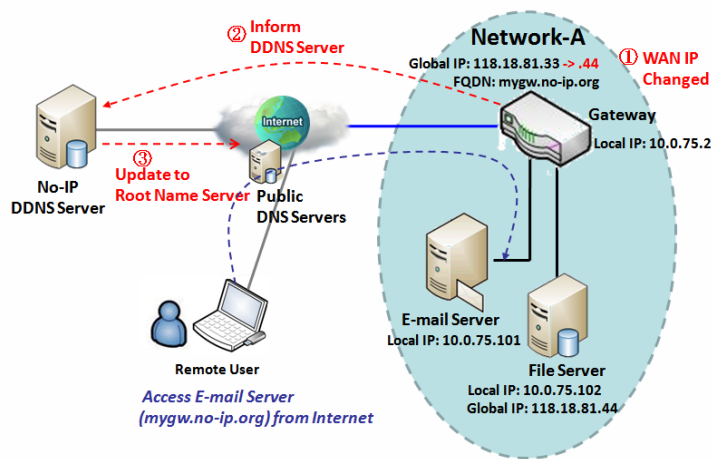

To host your server on a changing IP address, you have to use dynamic domain name service (DDNS). Therefore, anyone wishing to reach your host only needs to know the domain name. Dynamic DNS will map the name of your host to your current IP address, which changes each time you connect your Internet service provider.

The Dynamic DNS service allows the gateway to alias a public dynamic IP address to a static domain name, allowing the gateway to be more easily accessed from various locations on the Internet. As shown in the diagram, user registered a domain name to a

third-party DDNS service provider (NO-IP) to use DDNS function. Once the IP address of designated WAN interface has changed, the dynamic DNS agent in the gateway will inform the DDNS server with the new IP address. The server automatically re-maps your domain name with the changed IP address. So, other hosts or remote users in the Internet world are able to link to your gateway by using your domain name regardless of the changing global IP address.

7 http://en.wikipedia.org/wiki/Domain_Name_System

8 http://en.wikipedia.org/wiki/Dynamic_DNS

4G IIoT LoRa Gateway

DNS & DDNS Setting

Go to **Basic Network > DNS & DDNS > Configuration** Tab.

The DNS & DDNS setting allows user to setup Dynamic DNS feature and DNS redirect rules.

Setup Dynamic DNS

The gateway allows you to custom your Dynamic DNS settings.

Item	Setting
▶ DDNS	<input type="checkbox"/> Enable
▶ WAN Interface	WAN-1
▶ Provider	DynDNS.org(Dynamic)
▶ Host Name	
▶ User Name / E-Mail	
▶ Password / Key	

DDNS (Dynamic DNS) Configuration		
Item	Value setting	Description
DDNS	The box is unchecked by default	Check the Enable box to activate this function.
WAN Interface	WAN 1 is set by default	Select the WAN Interface IP Address of the gateway.
Provider	DynDNS.org (Dynamic) is set by default	Select your DDNS provider of Dynamic DNS. It can be DynDNS.org(Dynamic) , DynDNS.org(Custom) , NO-IP.com , etc...
Host Name	1. String format can be any text 2. A Must filled setting	Your registered host name of Dynamic DNS. Value Range: 0 ~ 63 characters.
User Name / E-Mail	1. String format can be any text 2. A Must filled setting	Enter your User name or E-mail addresss of Dynamic DNS.
Password / Key	1. String format can be any text 2. A Must filled setting	Enter your Password or Key of Dynamic DNS.
Save	N/A	Click Save to save the settings
Undo	N/A	Click Undo to cancel the settings

4G IIoT LoRa Gateway

Setup DNS Redirect

DNS redirect is a special function to redirect certain traffics to a specified host. Administator can manage the internet / intranet traffics that are going to access some restricted DNS and force those traffics to be redirected to a specified host.

DNS Redirect	
Item	Setting
▶ DNS Redirect	<input type="checkbox"/> Enable

DNS Redirect Configuration		
Item	Value setting	Description
DNS Redirect	The box is unchecked by default	Check the Enable box to activate this function.
Save	N/A	Click Save to save the settings
Undo	N/A	Click Undo to cancel the settings

If you enabled the DNS Redirect function, you have to further specify the redirect rules. According to the rules, the gateway can redirect the traffic that matched the DNS to corresponding pre-defined IP address.

Redirect Rule					
ID	Mapping Rule	Condition	Description	Enable	Action

When **Add** button is applied, **Redirect Rule** screen will appear.

Redirect Rule					
Item	Setting				
Mapping Rule	<table border="1"><thead><tr><th>Domain Name</th><th>IP</th></tr></thead><tbody><tr><td><input type="text"/> (* for Any)</td><td><input type="text"/></td></tr></tbody></table>	Domain Name	IP	<input type="text"/> (* for Any)	<input type="text"/>
	Domain Name	IP			
<input type="text"/> (* for Any)	<input type="text"/>				
Condition	<input type="text" value="Always"/>				
Description	<input type="text"/>				
Enable	<input type="checkbox"/> Enable				

Redirect Rule Configuration		
Item	Value setting	Description
Domain Name	1. String format can be any text	Enter a domain name to be redirect. The traffic to specified domain name will be redirect to the following IP address.

4G IIoT LoRa Gateway

	2. A Must filled setting	<i>Value Range:</i> at least 1 character is required; '*' for any.
IP	1. IPv4 format 2. A Must filled setting	Enter an IP Address as the target for the DNS redirect.
Condition	1. A Must filled setting 2. Always is selected by default.	Specify when will the DNS redirect action can be applied. It can be Always , or WAN Block . Always: The DNS redirect function can be applied to matched DNS all the time. WAN Block: The DNS redirect function can be applied to matched DNS only when the WAN connection is disconnected, or un-reachable.
Description	1. String format can be any text 2. A Must filled setting	Enter a brief description for this rule. <i>Value Range:</i> 0 ~ 63 characters.
Enable	The box is unchecked by default	Click the Enable button to activate this rule.
Save	N/A	Click Save to save the settings
Undo	N/A	Click Undo to cancel the settings

4G IIoT LoRa Gateway

2.8 QoS

The total amount of data traffic increases nowadays as the higher demand of mobile applications, like Game / Chat / VoIP / P2P / Video / Web access. In order to pose new requirements for data transport, e.g. low latency, low data loss, the entire network must ensure them via a connection service guarantee.

The main goal of QoS (Quality of Service) is prioritizing incoming data, and preventing data loss due to factors such as jitter, delay and dropping. Another important aspect of QoS is ensuring that prioritizing one data flow doesn't interfere with other data flows. So, QoS helps to prioritize data as it enters your router. By attaching special identification marks or headers to incoming packets, QoS determines which queue the packets enter, based on priority. This is useful when there are certain types of data you want to give higher priority to, such as voice packets given higher priority than Web data packets.

To utilize your network throughput completely, administrator must define bandwidth control rules carefully to balance the utilization of network bandwidth for all users to access. It is indeed required that an access gateway satisfies the requirements of latency-critical applications, minimum access right guarantee, fair bandwidth usage for same subscribed condition and flexible bandwidth management. AMIT Security Gateway provides a Rule-based QoS to carry out the requirements.

2.8.1 QoS Configuration

This gateway provides lots of flexible rules for you to set QoS policies. Basically, you need to know three parts of information before you create your own policies. First, "who" needs to be managed? Second, "what" kind of service needs to be managed? The last part is "how" you prioritize. Once you have this information, you can continue to learn functions in this section in more detail.

[QoS Rule Configuration](#)

When you want to add a new QoS rule or edit one already existed, the "QoS Rule Configuration" window shows up for you to configure. The parameters in a rule include the applied WAN interfaces, the dedicated host group based on MAC address or IP address, the dedicated kind of service packets, the system resource to be distributed, the corresponding control function for your specified resource, the packet flow direction, the sharing method for the control function, the integrated time schedule rule and the rule activation. Following diagram illustrates how to organize a QoS rule.

4G IIoT LoRa Gateway

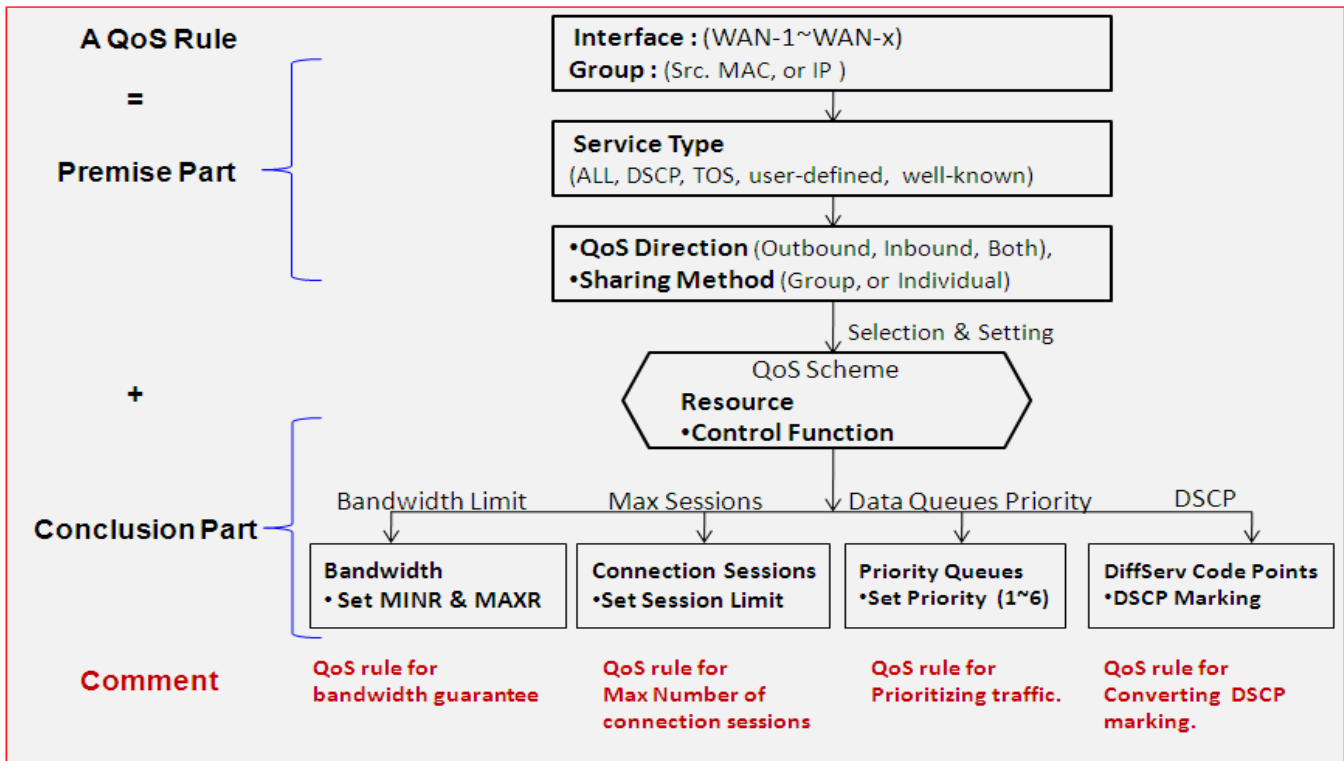

In above diagram, a QoS rule is organized by the premise part and the conclusion part. In the premise part, you must specify the WAN interface, host group, service type in the packets, packet flow direction to be watched and the sharing method of group control or individual control. However, in the conclusion part, you must make sure which kind of system resource to distribute and the control function based on the chosen system resource for the rule.

The Rule-based QoS has following features.

Multiple Group Categories

Specify the group category in a QoS rule for the target objects to be applied on.

Group Category can be based on VLAN ID, MAC Address, IP Address, Host Name or Packet Length.

Differentiated Services

Specify the service type in a QoS rule for the target packets to be applied on.

Differentiated services can be based on 802.1p, DSCP, TOS, VLAN ID, User-defined Services and Well-known Services. Well-known services include FTP(21), SSH(TCP:22), Telnet(23), SMTP(25), DNS(53), TFTP(UDP:69), HTTP(TCP:80), POP3(110), Auth(113), SFTP(TCP:115), SNMP&Traps(UDP:161-162), LDAP(TCP:389), HTTPS(TCP:443), SMTPs(TCP:465), ISAKMP(500), RTSP(TCP:554), POP3s(TCP:995), NetMeeting(1720), L2TP(UDP:1701) and PPTP(TCP:1723).

Available Control Functions

There are 4 resources can be applied in a QoS rule: bandwidth, connection sessions, priority queues and DiffServ Code Point (DSCP). Control function that acts on target objects for specific services of packet flow is based on these resources.

4G IIoT LoRa Gateway

For bandwidth resource, control functions include guaranteeing bandwidth and limiting bandwidth. For priority queue resource, control function is setting priority. For DSCP resource, control function is DSCP marking. The last resource is Connection Sessions; the related control function is limiting connection sessions.

Individual / Group Control

One QoS rule can be applied to individual member or whole group in the target group. This feature depends on model.

Outbound / Inbound Control

One QoS rule can be applied to the outbound or inbound direction of packet flow, even them both. This feature depends on model.

Two QoS rule examples are listed as below.

QoS Rule Example #1 - Connection Sessions

QoS Rule Configuration	
Item	Setting
▶ Interface	WAN - 1
▶ Group	IP 10.0.75.16 Subnet Mask : 255.255.255.240 (/28)
▶ Service	All
▶ Queue Outbound	N/A
▶ Queue Inbound	N/A
▶ Time Schedule	(0) Always
▶ Rule Enable	<input checked="" type="checkbox"/> Enable

When administrator wants to limit maximum connection sessions from some client hosts (IP 10.0.75.16~31) to 20000 to avoid resource unbalanced, he can setup this rule as above configuration.

This rule defines that all client hosts, whose IP address is in the range of 10.0.75.16~31, can access the Internet via "WAN-1" interface under the limitation of the maximum 20000 connection sessions totally at any time

4G IIoT LoRa Gateway

QoS Rule Example #2 – DifferServ Code Points

QoS Rule Configuration	
Item	Setting
▶ Interface	All WANs ▾
▶ Group	IP ▾ 10.0.75.196 Subnet Mask : 255.255.255.252 (/30) ▾
▶ Service	DSCP ▾ ▶ DiffServ CodePoint IP Precedence 4(CS4) ▾
▶ Queue Outbound	N/A
▶ Queue Inbound	N/A
▶ Time Schedule	(0) Always ▾
▶ Rule Enable	<input checked="" type="checkbox"/> Enable

When the administrator of the gateway wants to convert the code point value, "IP Precedence 4(CS4)", in the packets from some client hosts (IP 10.0.75.196~199) to the code value, "AF Class2(High Drop)", he can use the "Rule-based QoS" function to carry out this rule by defining an QoS rule as shown in above configuration. Under such configuration, all packets from WAN interfaces to LAN IP address 10.0.75.196 ~ 10.0.75.199 which have DiffServ code points with "IP Precedence 4(CS4)" value will be modified by "DSCP Marking" control function with "AF Class 2(High Drop)" value at any time.

4G IIoT LoRa Gateway

QoS Configuration Setting

Go to **Basic Network > QoS > Configuration** tab.

In "QoS Configuration" page, there are some configuration windows for QoS function. They are the "Configuration" window, "System Resource Configuration" window, "QoS Rule List" window, and "QoS Rule Configuration" window.

The "Configuration" window can let you activate the Rule-based QoS function. In addition, you can also enable the "Flexible Bandwidth Management" (FBM) feature for better utilization of system bandwidth by FBM algorithm. Second, the "System Configuration" window can let you configure the total bandwidth and session of each WAN. Third, the "QoS Rule List" window lists all your defined QoS rules. At last, the "QoS Rule Configuration" window can let you define one QoS rule.

Enable QoS Function

Configuration	
Item	Setting
▶ QoS Types	Software <input type="checkbox"/> Enable
▶ Flexible Bandwidth Management	<input type="checkbox"/> Enable

Configuration Item	Value Setting	Description
QoS Type	1. Software is selected by default. 2. The box is unchecked by default.	Select the QoS Type from the dropdown list, and then click Enable box to activate the QoS function. The default QoS type is set to Software QoS. For some models, there is another option for Hardware QoS.
Flexible Bandwidth Management	The box is unchecked by default	Click Enable box to activate the Flexible Bandwidth Management function.
Save	N/A	Click the Save button to save the settings.

Check the "Enable" box to activate the "Rule-based QoS" function. Also enable the Flexible Bandwidth Management (FBM) feature when needed. When FBM is enabled, system adjusts the bandwidth distribution dynamically based on current bandwidth usage situation to reach maximum system network performance while transparent to all users. Certainly, the bandwidth subscription profiles of all current users are considered in system's automatic adjusting algorithm.

4G IIoT LoRa Gateway

Setup System Resource

System Resource Configuration	
Item	Setting
Type of System Queue	Bandwidth Queue 6 (1~6)
WAN Interface	WAN - 1

WAN Interface Resource	
Item	Setting
Bandwidth of Upstream	100 Mbps
Bandwidth of Downstream	100 Mbps
Total Connection Sessions	30000 (1~100000)

System Resource Configuration		
Item	Value Setting	Description
Type of System Queue	1. A Must filled setting. 2. Bandwidth Queue , and 6 are set by default.	Define the system queues that are available for the QoS settings. The supported type of system queues are Bandwidth Queue and Priority Queues . Value Range: 1 ~ 6.
WAN Interface	WAN-1 is selected by default.	Select the WAN interface and then the following WAN Interface Resource screen will show the related resources for configuration. <ul style="list-style-type: none"> Bandwidth of Upstream / Downstream Specify total upload / download bandwidth of the selected WAN. Value Range: For Gigabit Ethernet: 1~1024000Kbps, or 1~1000Mbps; For Fast Ethernet: 1~102400Kbps, or 1~100Mbps; For 3G/4G: 1~153600Kbps, or 1~150Mbps. Total Connection Sessions Specify total connection sessions of the selected WAN. Value Range: 1 ~ 10000.
Save	N/A	Click the Save button to save the settings.

Each WAN interface should be configured carefully for its upstream bandwidth, downstream bandwidth and maximum number of connection sessions.

4G IIoT LoRa Gateway

Create / Edit QoS Rules

After enabled the QoS function and configured the system resources, you have to further specify some QoS rules for provide better service on the interested traffics. The gateway supports up to a maximum of 128 rule-based QoS rule sets.

QoS Rule List									
Interface	Group	Service	Resource	Control Function	Direction	Sharing Method	Time Schedule	Enable	Actions

When **Add** button is applied, **QoS Rule Configuration** screen will appear.

QoS Rule Configuration	
Item	Setting
▶ Interface	All WANs ▾
▶ Group	Src. MAC Address ▾ <input type="text"/>
▶ Service	All ▾
▶ Resource	Bandwidth ▾
▶ Control Function	Set MINR & MAXR ▾ <input type="text"/> --- <input type="text"/> Mbps ▾
▶ QoS Direction	Outbound ▾
▶ Time Schedule	(0) Always ▾
▶ Rule Enable	<input type="checkbox"/> Enable

QoS Rule Configuration		
Item	Value setting	Description
Interface	<ol style="list-style-type: none"> 1. A Must filled setting. 2. All WANs is selected by default. 	Specify the WAN interface to apply the QoS rule. Select All WANs or a certain WAN-n to filter the packets entering to or leaving from the interface(s).
Group	<ol style="list-style-type: none"> 1. A Must filled setting. 2. Src. MAC Address is selected by default. 	<p>Specify the Group category for the QoS rule. It can be Src. MAC Address, IP, or Host Name.</p> <p>Select Src. MAC Address to prioritize packets based on MAC;</p> <p>Select IP to prioritize packets based on IP address and Subnet Mask;</p> <p>Select Host Name to prioritize packets based on a group of a pre-configured group of host from the dropdown list. If the dropdown list is empty, ensure if any group is pre-configured.</p> <p>Note: The required host groups must be created in advance and corresponding QoS checkbox in the Multiple Bound Services field is checked before the Host</p>

4G IIoT LoRa Gateway

		<p>Group option become available. Refer to Object Definition > Grouping > Host Grouping.</p>
Service	<p>1. A Must filled setting. 2. All is selected by default.</p>	<p>Specify the service type of traffics that have to be applied with the QoS rule. It can be All, DSCP, TOS, User-defined Service, or Well-known Service.</p> <p>Select All for all packets.</p> <p>Select DSCP for DSCP type packets only.</p> <p>Select TOS for TOS type packets only. You have to select a service type (Minimize-Cost, Maximize-Reliability, Maximize-Throughput, or Minimize-Delay) from the dropdown list as well.</p> <p>Select User-defined Service for user-defined packets only. You have to define the port range and protocol as well.</p> <p>Select Well-known Service for specific application packets only. You have to select the required service from the dropdown list as well.</p>
Resource, and Control Function	A Must filled setting	<p>Specify the Resource Type and corresponding Control function for the QoS rule. The available Resource options are Bandwidth, Connection Sessions, Priority Queues, and DiffServ Codepoints.</p> <p>Bandwidth: Select Bandwidth as the resource type for the QoS Rule, and you have to assign the min rate, max rate and rate unit as the bandwidth settings in the Control Function / Set MINR & MAXR field.</p> <p>Connection Sessions: Select Connection Sessions as the resource type for the QoS Rule, and you have to assign supported session number in the Control Function / Set Session Limitation field.</p> <p>Priority Queues: Select Priority Queues as the resource type for the QoS Rule, and you have to specify a priority queue in the Control Function / Set Priority field.</p> <p>DiffServ Code Points: Select DiffServ Code Points as the resource type for the QoS Rule, and you have to select a DSCP marking from the Control Function / DSCP Marking dropdown list.</p>
QoS Direction	<p>1. A Must filled setting. 2. Outbound is selected by default.</p>	<p>Specify the traffic flow direction for the packets to apply the QoS rule. It can be Outbound, Inbound, or Both.</p> <p>Outbound: Select Outbound to prioritize the traffics going to the Internet via the specified interface. Under such situation, the hosts specified in the Group field is a source group.</p> <p>Inbound: Select Inbound to prioritize the traffics coming from the Internet via the specified interface. Under such situation, the hosts specified in the Group field is a destination group.</p> <p>Both: Select both to prioritize the traffics passing through the specified interface, both Inbound and Outbound are considered. Under such situation, the hosts specified in the Group field can be a source or destination group.</p>
Sharing Method	1. A Must filled	Specify the preferred sharing method for how to apply the QoS rule on the

4G IIoT LoRa Gateway

	setting. 2. Group Control is selected by default.	selected group. It can be Individual Control or Group Control . Individual Control: If Individual Control is selected, each host in the group will have his own QoS service resource as specified in the rule. Group Control: If Group Control is selected, all the group hosts share the same QoS service resource.
Time Schedule	1. A Must filled setting. 2. (0) Always is selected by default.	Apply Time Schedule to this rule; otherwise leave it as (0) Always . (refer to Object Definition > Scheduling > Configuration settings)
Rule Enable	The box is unchecked by default.	Click Enable box to activate this QoS rule.
Save	N/A	Click the Save button to save the settings.

4G IIoT LoRa Gateway

2.9 Redundancy

In engineering, redundancy is the duplication of critical components or functions of a system with the intention of increasing reliability of the system, usually in the form of a backup or fail-safe. In an IP networking, the access gateway is the critical part of the networking system. Redundant gateway plays the backup one of the master gateway and it will take over the data transmitting job once it finds the master gateway failed.

The purchased gateway can serve as the redundant gateway of core router in the enterprise by using the Virtual Router Redundancy Protocol (VRRP).

2.9.1 VRRP

Configuration	
Item	Setting
▶ VRRP	<input type="checkbox"/> Enable
▶ Virtual Server ID	<input type="text"/> (1-255)
▶ Priority of Virtual Server	<input type="text"/> (Lowest 1 ~ 254 Highest)
▶ Virtual Server IP Address	<input type="text"/>

Virtual Router Redundancy Protocol (VRRP) is a computer networking protocol providing device redundancy. It allows a backup router or switch to automatically take over if the primary (master) router or switch fails. This increases the availability and reliability of routing paths via automatic default gateway selections on an IP network.

The protocol achieves this by creation of virtual routers, which are an abstract representation of multiple routers, i.e. master and backup routers, acting as a group. The default gateway of a participating host is assigned to the virtual router instead of a physical router. If the physical router that is routing packets on behalf of the virtual router fails, another physical router is selected to automatically replace it. The physical router that is forwarding packets at any given time is called the master router.

A group of physical VRRP gateways combined together to play a virtual server with one unique virtual server ID and one unique virtual server IP address. But these VRRP gateways have their own priority values to serve as the sequence for backing up the master gateway.

The gateway with VRRP function can join one group of redundant gateways to serve as the backup one for the master gateway. Fill same values of virtual server ID and IP for these gateways, and each gateway owns its own priority as the sequence in the backup list. They construct a VRRP redundant gateway group. Following diagram illustrates the group example with two member gateways.

4G IIoT LoRa Gateway

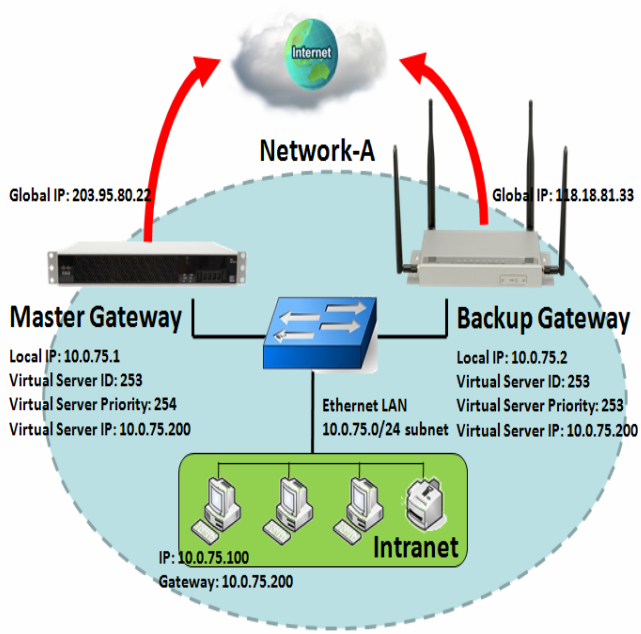

As shown in the diagram, Master Gateway and Backup Gateway are redundant gateway group of Network-A. Subnet of network-A is 10.0.75.0/24. Master gateway has LAN IP 10.0.75.1 and WAN IP 203.95.80.22. Backup gateway has LAN IP 10.0.75.2 and 118.18.81.33 for WAN-1. They both serve as NAT routers.

Specify the ID of VRRP virtual server to be "253" and its IP address to be "10.0.75.200". The priority of the master gateway is 254 and it is larger than the one (253) of the backup gateway. At first stage, all data from the Intranet go through the master gateway that has the highest priority. Once the master Internet connection is broken, the backup gateway will take over the data transmitting job and serve as the master gateway.

When a gateway with higher priority recovers from broken connection, it will take over data transmitting again.

VRRP Setting

The Virtual Router Redundancy Protocol (VRRP) setting allows user to assign available Internet Protocol (IP) routers to participating hosts automatically.

Go to **Basic Network > Redundancy > VRRP** tab.

Configuration	
Item	Setting
VRRP	<input type="checkbox"/> Enable
Virtual Server ID	<input type="text"/> (1-255)
Priority of Virtual Server	<input type="text"/> (Lowest 1 ~ 254 Highest)
Virtual Server IP Address	<input type="text"/>

VRRP Item	Value setting	Description
VRRP	The box is unchecked by	Check the Enable box to activate this VRRP function.

4G IIoT LoRa Gateway

	default.	
Virtual Server ID	1. Numeric String Format 2. A Must filled setting	Specify the Virtual Server ID on VRRP of the gateway. <i>Value Range: 1 ~ 255.</i>
Priority of Virtual Server	1. Numeric String Format 2. A Must filled setting	Specify the Priority of Virtual Server on VRRP of the gateway. <i>Value Range: 1 ~ 254, and 254 is the highest priority.</i>
Virtual Server IP Address	1. IPv4 Format 2. A Must filled setting	Specify the Virtual Server IP Address on VRRP of the gateway.
Save	N/A	Click the Save button to save the configuration.
Undo	N/A	Click the Undo button to restore what you just configured back to the previous setting.

Chapter 3 Object Definition

3.1 Scheduling

Scheduling provides ability of adding/deleting time schedule rules, which can be applied to other functionality.

3.1.1 Scheduling Configuration

Go to **Object Definition > Scheduling > Configuration** tab.

Time Schedule List		
ID	Rule Name	Actions

Button description		
Item	Value setting	Description
Add	N/A	Click the Add button to configure time schedule rule
Delete	N/A	Click the Delete button to delete selected rule(s)

When **Add** button is applied, Time Schedule Configuration and Time Period Definition screens will appear.

Time Schedule Configuration	
Item	Setting
▶ Rule Name	<input type="text"/>
▶ Rule Policy	<input type="text" value="Inactivate"/> the Selected Days and Hours Below.

Time Schedule Configuration		
Item	Value Setting	Description
Rule Name	String: any text	Set rule name
Rule Policy	Default Inactivate	Inactivate/activate the function been applied to in the time period below

4G IIoT LoRa Gateway

Time Period Definition			
ID	Week Day	Start Time (hh:mm)	End Time (hh:mm)
1	-- choose one --	<input type="text"/>	<input type="text"/>
2	-- choose one --	<input type="text"/>	<input type="text"/>
3	-- choose one --	<input type="text"/>	<input type="text"/>
4	-- choose one --	<input type="text"/>	<input type="text"/>
5	-- choose one --	<input type="text"/>	<input type="text"/>
6	-- choose one --	<input type="text"/>	<input type="text"/>
7	-- choose one --	<input type="text"/>	<input type="text"/>
8	-- choose one --	<input type="text"/>	<input type="text"/>

Time Period Definition		
Item	Value Setting	Description
Week Day	Select from menu	Select everyday or one of weekday
Start Time	Time format (hh :mm)	Start time in selected weekday
End Time	Time format (hh :mm)	End time in selected weekday
Save	N/A	Click Save to save the settings
Undo	N/A	Click Undo to cancel the settings
Refresh	N/A	Click the Refresh button to refresh the time schedule list.

4G IIoT LoRa Gateway

3.2 User (not supported)

Not supported feature for the purchased product, leave it as blank.

4G IIoT LoRa Gateway

3.3 Grouping

The Grouping function allows user to make group for some services.

3.3.1 Host Grouping

Go to **Object Definition > Grouping > Host Grouping** tab.

The Host Grouping function allows user to make host group for some services, such as QoS, Firewall, and Communication Bus. The supported service types could be different for the purchased product.

Host Group List						
ID	Group Name	Group Type	Member List	Bound Services	Enable	Actions

When **Add** button is applied, **Host Group Configuration** screen will appear.

Host Group Configuration	
Item	Setting
▶ Group Name	<input type="text"/>
▶ Group Type	<input type="text" value="IP Address-based"/>
▶ Member to Join	<input type="text"/> <input type="button" value="Join"/>
▶ Member List	
▶ Bound Services	<input type="checkbox"/> Firewall <input type="checkbox"/> QoS
▶ Group	<input type="checkbox"/> Enable

Host Group Configuration		
Item	Value setting	Description
Group Name	1. String format can be any text 2. A Must filled setting	Enter a group name for the rule. It is a name that is easy for you to understand.
Group Type	1. IP Address-based is selected by default. 2. A Must filled setting	Select the group type for the host group. It can be IP Address-based , MAC Address-based , or Host Name-based . When IP Address-based is selected, only IP address can be added in Member to Join . When MAC Address-based is selected, only MAC address can be added in Member to Join .

4G IIoT LoRa Gateway

		<p>When Host Name-based is selected, only host name can be added in Member to Join.</p> <p>Note: The available Group Type can be different for the purchased model.</p>
Member to Join	N/A	<p>Add the members to the group in this field.</p> <p>You can enter the member information as specified in the Member Type above, and press the Join button to add.</p> <p>Only one member can be add at a time, so you have to add the members to the group one by one.</p>
Member List	NA	<p>This field will indicate the hosts (members) contained in the group.</p>
Bound Services	The boxes are unchecked by default	<p>Binding the services that the host group can be applied. If you enable the Firewall, the produced group can be used in firewall service. Same as by enable QoS, or other available service types.</p> <p>Note: The supported service type can be different for the purchased product.</p>
Group	The box is unchecked by default	<p>Check the Enable checkbox to activate the host group rule. So that the group can be bound to selected service(s) for further configuration.</p>
Save	N/A	<p>Click Save to save the settings</p>
Undo	N/A	<p>Click Undo to cancel the settings</p>

4G IIoT LoRa Gateway

3.4 External Server

Go to **Object Definition > External Server > External Server** tab.

The External Server setting allows user to add external server.

Create External Server

External Server List Add Delete						
ID	Server Name	Server Type	Server IP/FQDN	Server Port	Server Enable	Actions

When **Add** button is applied, **External Server Configuration** screen will appear.

External Server Configuration	
Item	Setting
▶ Server Name	<input type="text"/>
▶ Server Type	Email Server <input type="text"/> User Name: <input type="text"/> Password: <input type="text"/>
▶ Server IP/FQDN	<input type="text"/>
▶ Server Port	<input type="text" value="25"/>
▶ Server	<input checked="" type="checkbox"/> Enable
Save Undo	

4G IIoT LoRa Gateway

External Server Configuration		
Item	Value setting	Description
Sever Name	1. String format can be any text 2. A Must filled setting	Enter a server name. Enter a name that is easy for you to understand.
Server Type	A Must filled setting	<p>Specify the Server Type of the external server, and enter the required settings for the accessing the server.</p> <hr/> <p>Email Server (A Must filled setting) : When Email Server is selected, User Name, and Password are also required. User Name (String format: any text) Password (String format: any text)</p> <hr/> <p>RADIUS Server (A Must filled setting) : When RADIUS Server is selected, the following settings are also required. Primary : Shared Key (String format: any text) Authentication Protocol (By default CHAP is selected) Session Timeout (By default 1) The values must be between 1 and 60. Idle Timeout: (By default 1) The values must be between 1 and 15. Secondary : Shared Key (String format: any text) Authentication Protocol (By default CHAP is selected) Session Timeout (By default 1) The values must be between 1 and 60. Idle Timeout: (By default 1) The values must be between 1 and 15.</p> <hr/> <p>Active Directory Server (A Must filled setting) : When Active Directory Server is selected, Domain setting is also required. Domain (String format: any text)</p> <hr/> <p>LDAP Server (A Must filled setting) : When LDAP Server is selected, the following settings are also required. Base DN (String format: any text) Identity (String format: any text) Password (String format: any text)</p> <hr/> <p>UAM Server (A Must filled setting) : When UAM Server is selected, the following settings are also required. Login URL (String format: any text) Shared Secret (String format: any text) NAS/Gateway ID (String format: any text) Location ID (String format: any text) Location Name (String format: any text)</p>

4G IIoT LoRa Gateway

		<p>TACACS+ Server (A Must filled setting) :</p> <p>When TACACS+ Server is selected, the following settings are also required.</p> <p>Shared Key (String format: any text)</p> <p>Session Timeout (String format: any number)</p> <p>The values must be between 1 and 60.</p> <hr/> <p>SCEP Server (A Must filled setting) :</p> <p>When SCEP Server is selected, the following settings are also required.</p> <p>Path (String format: any text, By default cgi-bin is filled)</p> <p>Application (String format: any text, By default pkiclient.exe is filled)</p> <hr/> <p>FTP(SFTP) Server (A Must filled setting) :</p> <p>When FTP(SFTP) Server is selected, the following settings are also required.</p> <p>User Name (String format: any text)</p> <p>Password (String format: any text)</p> <p>Protocol (Select FTP or SFTP)</p> <p>Encryprion (Select Plain, Explicit FTPS or Implicit FTPS)</p> <p>Transfer mode (Select Passive or Active)</p>
Server IP/FQDN	A Must filled setting	Specify the IP address or FQDN used for the external server.
Server Port	A Must filled setting	<p>Specify the Port used for the external server. If you selected a certain server type, the default server port number will be set.</p> <p>For Email Server 25 will be set by default;</p> <p>For Syslog Server, port 514 will be set by default;</p> <p>For RADIUS Server, port 1812, 1823 will be set by default;</p> <p>For Active Directory Server, port 389 will be set by default;</p> <p>For LDAP Server, port 389 will be set by default;</p> <p>For UAM Server, port 3990, 4990 will be set by default;</p> <p>For TACACS+ Server, port 49 will be set by default;</p> <p>For SCEP Server, port 80 will be set by default;</p> <p>For FTP(SFTP) Server, port 21 will be set by default;</p> <p>For LoRa Server, port 1700 will be set by default;</p> <p><u>Value Range: 1 ~ 65535.</u></p>
Account Port	<p>1. A Must filled setting</p> <p>2. 1813 is set by default</p>	<p>Specify the accounting port used if you selected external RADIUS server.</p> <p><u>Value Range: 1 ~ 65535.</u></p>
Server	The box is checked by default	Click Enable to activate this External Server.
Save	N/A	Click Save to save the settings
Undo	N/A	Click Undo to cancel the settings
Refresh	N/A	Click the Refresh button to refresh the external server list.

4G IIoT LoRa Gateway

3.5 Certificate

In cryptography, a public key certificate (also known as a digital certificate or identity certificate) is an electronic document used to prove ownership of a public key. The certificate includes information about the key, information about its owner's identity, and the digital signature of an entity that has verified the certificate's contents are genuine. If the signature is valid, and the person examining the certificate trusts the signer, then they know they can use that key to communicate with its owner⁹.

In a typical public-key infrastructure (PKI) scheme, the signer is a certificate authority (CA), usually a company such as VeriSign which charges customers to issue certificates for them. In a web of trust scheme, the signer is either the key's owner (a self-signed certificate) or other users ("endorsements") whom the person examining the certificate might know and trust. The device also plays as a CA role.

Certificates are an important component of Transport Layer Security (TLS, sometimes called by its older name SSL), where they prevent an attacker from impersonating a secure website or other server. They are also used in other important applications, such as email encryption and code signing. Here, it can be used in IPSec tunneling for user authentication.

3.5.1 Configuration

The configuration setting allows user to create Root Certificate Authority (CA) certificate and configure to set enable of SCEP. Root CA is the top-most certificate of the tree, the private key of which is used to "sign" other certificates.

Go to **Object Definition > Certificate > Configuration** tab.

Create Root CA

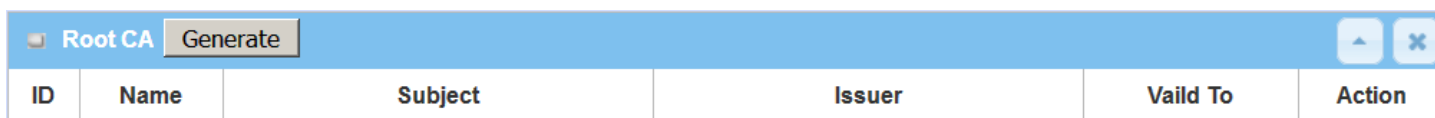

ID	Name	Subject	Issuer	Valid To	Action
----	------	---------	--------	----------	--------

When **Generate** button is applied, **Root CA Certificate Configuration** screen will appear. The required information to be filled for the root CA includes the name, key, subject name and validity.

⁹ http://en.wikipedia.org/wiki/Public_key_certificate.

4G IIoT LoRa Gateway

Root CA Certificate Configuration	
Item	Setting
▶ Name	<input type="text"/>
▶ Key	Key Type : <input type="text" value="RSA"/> Key Length : <input type="text" value="512-bits"/> Digest Algorithm : <input type="text" value="MD5"/>
▶ Subject Name	Country(C) : <input type="text"/> State(ST) : <input type="text"/> Location(L) : <input type="text"/> Organization(O) : <input type="text"/> Organization Unit(OU) : <input type="text"/> Common Name(CN) : <input type="text"/> E-mail : <input type="text"/>
▶ Validity Period	<input type="text" value="20-years"/>

Root CA Certificate Configuration		
Item	Value setting	Description
Name	1. String format can be any text 2. A Must filled setting	Enter a Root CA Certificate name. It will be a certificate file name
Key	A Must filled setting	This field is to specify the key attribute of certificate. Key Type to set public-key cryptosystems. It only supports RSA now. Key Length to set s the size measured in bits of the key used in a cryptographic algorithm. Digest Algorithm to set identifier in the signature algorithm identifier of certificates
Subject Name	A Must filled setting	This field is to specify the information of certificate. Country(C) is the two-letter ISO code for the country where your organization is located. State(ST) is the state where your organization is located. Location(L) is the location where your organization is located. Organization(O) is the name of your organization. Organization Unit(OU) is the name of your organization unit. Common Name(CN) is the name of your organization. Email is the email of your organization. It has to be email address style.
Validity Period	A Must filled setting	This field is to specify the validity period of certificate.

4G IIoT LoRa Gateway

Setup SCEP

SCEP Configuration	
Item	Setting
▶ SCEP	<input type="checkbox"/> Enable
▶ Automatically re-enroll aging certificates	<input type="checkbox"/> Enable

SCEP Configuration		
Item	Value setting	Description
SCEP	The box is unchecked by default	Check the Enable box to activate SCEP function.
Automatically re-enroll aging certificates	The box is unchecked by default	When SCEP is activated, check the Enable box to activate this function. It will be automatically check which certificate is aging. If certificate is aging, it will activate SCEP function to re-enroll automatically.
Save	N/A	Click Save to save the settings
Undo	N/A	Click Undo to cancel the settings

4G IIoT LoRa Gateway

3.5.2 My Certificate

My Certificate includes a Local Certificate List. Local Certificate List shows all generated certificates by the root CA for the gateway. And it also stores the generated Certificate Signing Requests (CSR) which will be signed by other external CAs. The signed certificates can be imported as the local ones of the gateway.

Self-signed Certificate Usage Scenario

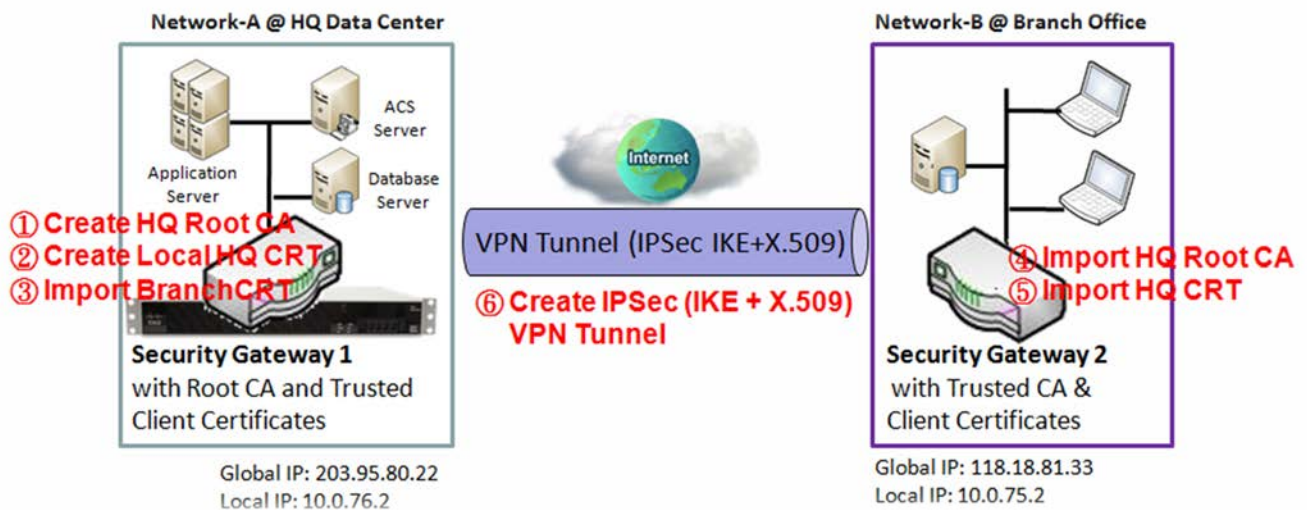

Scenario Application Timing

When the enterprise gateway owns the root CA and VPN tunneling function, it can generate its own local certificates by being signed by itself or import any local certificates that are signed by other external CAs. Also import the trusted certificates for other CAs and Clients. In addition, since it has the root CA, it also can sign Certificate Signing Requests (CSR) to form corresponding certificates for others. These certificates can be used for two remote peers to make sure their identity during establishing a VPN tunnel.

Scenario Description

Gateway 1 generates the root CA and a local certificate (HQCRT) signed by itself. Import a trusted certificate (BranchCRT) –a BranchCSR certificate of Gateway 2 signed by root CA of Gateway 1.

Gateway 2 creates a CSR (BranchCSR) to let the root CA of the Gateway 1 sign it to be the BranchCRT certificate. Import the certificate into the Gateway 2 as a local certificate. In addition, also import the certificates of the root CA of the Gateway 1 into the Gateway 2 as the trusted ones. (Please also refer to following two sub-sections)

Establish an IPSec VPN tunnel with IKE and X.509 protocols by starting from either peer, so that all

4G IIoT LoRa Gateway

client hosts in these both subnets can communicate with each other.

Parameter Setup Example

For Network-A at HQ

Following tables list the parameter configuration as an example for the "My Certificate" function used in the user authentication of IPsec VPN tunnel establishing, as shown in above diagram. The configuration example must be combined with the ones in following two sections to complete the whole user scenario.

Use default value for those parameters that are not mentioned in the tables.

Configuration Path	[My Certificate]-[Root CA Certificate Configuration]
Name	HQRootCA
Key	Key Type: RSA Key Length: 1024-bits
Subject Name	Country(C): TW State(ST): Taiwan Location(L): Tainan Organization(O): AMITHQ Organization Unit(OU): HQRD Common Name(CN): HQRootCA E-mail: hqrootca@amit.com.tw

Configuration Path	[My Certificate]-[Local Certificate Configuration]
Name	HQCRT Self-signed: <input checked="" type="checkbox"/>
Key	Key Type: RSA Key Length: 1024-bits
Subject Name	Country(C): TW State(ST): Taiwan Location(L): Tainan Organization(O): AMITHQ Organization Unit(OU): HQRD Common Name(CN): HQCRT E-mail: hqcert@amit.com.tw

Configuration Path	[IPSec]-[Configuration]
IPSec	<input checked="" type="checkbox"/> Enable

Configuration Path	[IPSec]-[Tunnel Configuration]
Tunnel	<input checked="" type="checkbox"/> Enable
Tunnel Name	s2s-101
Interface	WAN 1
Tunnel Scenario	Site to Site
Operation Mode	Always on

Configuration Path	[IPSec]-[Local & Remote Configuration]
Local Subnet	10.0.76.0
Local Netmask	255.255.255.0
Full Tunnel	Disable
Remote Subnet	10.0.75.0
Remote Netmask	255.255.255.0
Remote Gateway	118.18.81.33

4G IIoT LoRa Gateway

Configuration Path	[IPSec]-[Authentication]
Key Management	<i>IKE+X.509</i> Local Certificate: <i>HQCRT</i> Remote Certificate: <i>BranchCRT</i>
Local ID	<i>User Name Network-A</i>
Remote ID	<i>User Name Network-B</i>

Configuration Path	[IPSec]-[IKE Phase]
Negotiation Mode	<i>Main Mode</i>
X-Auth	<i>None</i>

For Network-B at Branch Office

Following tables list the parameter configuration as an example for the "My Certificate" function used in the user authentication of IPSec VPN tunnel establishing, as shown in above diagram. The configuration example must be combined with the ones in following two sections to complete the whole user scenario.

Use default value for those parameters that are not mentioned in the tables.

Configuration Path	[My Certificate]-[Local Certificate Configuration]
Name	<i>BranchCRT</i> Self-signed: <input type="checkbox"/>
Key	Key Type: <i>RSA</i> Key Length: <i>1024-bits</i>
Subject Name	Country(C): <i>TW</i> State(ST): <i>Taiwan</i> Location(L): <i>Tainan</i> Organization(O): <i>AMITBranch</i> Organization Unit(OU): <i>BranchRD</i> Common Name(CN): <i>BranchCRT</i> E-mail: <i>branchcrt@amit.com.tw</i>

Configuration Path	[IPSec]-[Configuration]
IPSec	■ <i>Enable</i>

Configuration Path	[IPSec]-[Tunnel Configuration]
Tunnel	■ <i>Enable</i>
Tunnel Name	<i>s2s-102</i>
Interface	<i>WAN 1</i>
Tunnel Scenario	<i>Site to Site</i>
Operation Mode	<i>Always on</i>

Configuration Path	[IPSec]-[Local & Remote Configuration]
Local Subnet	<i>10.0.75.0</i>
Local Netmask	<i>255.255.255.0</i>
Full Tunnel	<i>Disable</i>
Remote Subnet	<i>10.0.76.0</i>

4G IIoT LoRa Gateway

Remote Netmask	<i>255.255.255.0</i>
Remote Gateway	<i>203.95.80.22</i>

Configuration Path	[IPSec]-[Authentication]
Key Management	<i>IKE+X.509</i> Local Certificate: <i>BranchCRT</i> Remote Certificate: <i>HQCRT</i>
Local ID	<i>User Name Network-B</i>
Remote ID	<i>User Name Network-A</i>

Configuration Path	[IPSec]-[IKE Phase]
Negotiation Mode	<i>Main Mode</i>
X-Auth	<i>None</i>

Scenario Operation Procedure

In above diagram, "Gateway 1" is the gateway of Network-A in headquarters and the subnet of its Intranet is 10.0.76.0/24. It has the IP address of 10.0.76.2 for LAN interface and 203.95.80.22 for WAN-1 interface. "Gateway 2" is the gateway of Network-B in branch office and the subnet of its Intranet is 10.0.75.0/24. It has the IP address of 10.0.75.2 for LAN interface and 118.18.81.33 for WAN-1 interface. They both serve as the NAT security gateways.

Gateway 1 generates the root CA and a local certificate (HQCRT) that is signed by itself. Import the certificates of the root CA and HQCRT into the "Trusted CA Certificate List" and "Trusted Client Certificate List" of Gateway 2.

Gateway 2 generates a Certificate Signing Request (BranchCSR) for its own certificate (BranchCRT) (Please generate one not self-signed certificate in the Gateway 2, and click on the "View" button for that CSR. Just downloads it). Take the CSR to be signed by the root CA of Gateway 1 and obtain the BranchCRT certificate (you need rename it). Import the certificate into the "Trusted Client Certificate List" of the Gateway 1 and the "Local Certificate List" of Gateway 2.

Gateway 2 can establish an IPSec VPN tunnel with "Site to Site" scenario and IKE and X.509 protocols to Gateway 1.

Finally, the client hosts in two subnets of 10.0.75.0/24 and 10.0.76.0/24 can communicate with each other.

4G IIoT LoRa Gateway

My Certificate Setting

Go to **Object Definition > Certificate > My Certificate** tab.

The My Certificate setting allows user to create local certificates. In "My Certificate" page, there are two configuration windows for the "My Certificate" function. The "Local Certificate List" window shows the stored certificates or CSRs for representing the gateway. The "Local Certificate Configuration" window can let you fill required information necessary for corresponding certificate to be generated by itself, or corresponding CSR to be signed by other CAs.

Create Local Certificate

Local Certificate List					
ID	Name	Subject	Issuer	Valid To	Actions

When **Add** button is applied, **Local Certificate Configuration** screen will appear. The required information to be filled for the certificate or CSR includes the name, key and subject name. It is a certificate if the "Self-signed" box is checked; otherwise, it is a CSR.

Local Certificate Configuration	
Item	Setting
Name	<input type="text"/> Self-signed : <input type="checkbox"/>
Key	Key Type : <input type="text" value="RSA"/> Key Length : <input type="text" value="1024-bits"/> Digest Algorithm : <input type="text" value="SHA-1"/>
Subject Name	Country(C) : <input type="text"/> State(ST) : <input type="text"/> Location(L) : <input type="text"/> Organization(O) : <input type="text"/> Organization Unit(OU) : <input type="text"/> Common Name(CN) : <input type="text"/> E-mail : <input type="text"/>
Extra Attributes	Challenge Password: <input type="text"/> Unstructured Name: <input type="text"/>
SCEP Enrollment	Enable: <input type="checkbox"/> SCEP Server: <input type="text" value="--- Option ---"/> <input type="button" value="Add Object"/> CA Certificate: <input type="text" value="amit-IDG761AM-JH.crt"/> CA Encryption Certificate: <input type="text" value="--- Option ---"/> (Optional) CA Identifier: <input type="text"/> (Optional)

4G IIoT LoRa Gateway

Local Certificate Configuration		
Item	Value setting	Description
Name	1. String format can be any text 2. A Must filled setting	Enter a certificate name. It will be a certificate file name If Self-signed is checked, it will be signed by root CA. If Self-signed is not checked, it will generate a certificate signing request (CSR).
Key	A Must filled setting	This field is to specify the key attributes of certificate. Key Type to set public-key cryptosystems. Currently, only RSA is supported. Key Length to set the length in bits of the key used in a cryptographic algorithm. It can be 512/768/1024/1536/2048. Digest Algorithm to set identifier in the signature algorithm identifier of certificates. It can be MD5/SHA-1.
Subject Name	A Must filled setting	This field is to specify the information of certificate. Country(C) is the two-letter ISO code for the country where your organization is located. State(ST) is the state where your organization is located. Location(L) is the location where your organization is located. Organization(O) is the name of your organization. Organization Unit(OU) is the name of your organization unit. Common Name(CN) is the name of your organization. Email is the email of your organization. It has to be email address setting only.
Extra Attributes	A Must filled setting	This field is to specify the extra information for generating a certificate. Challenge Password for the password you can use to request certificate revocation in the future. Unstructured Name for additional information.
SCEP Enrollment	A Must filled setting	This field is to specify the information of SCEP. If user wants to generate a certificate signing request (CSR) and then signed by SCEP server online, user can check the Enable box. Select a SCEP Server to identify the SCEP server for use. The server detailed information could be specified in External Servers. Refer to Object Definition > External Server > External Server . You may click Add Object button to generate, and the settings are the same as those defined in Section 3.4 External Server . Select a CA Certificate to identify which certificate could be accepted by SCEP server for authentication. It could be generated in Trusted Certificates. Select an optional CA Encryption Certificate , if it is required, to identify which certificate could be accepted by SCEP server for encryption data information. It could be generated in Trusted Certificates. Fill in optional CA Identifier to identify which CA could be used for signing certificates.
Save	N/A	Click the Save button to save the configuration.
Back	N/A	When the Back button is clicked, the screen will return to previous page.

4G IIoT LoRa Gateway

When **Import** button is applied, an Import screen will appear. You can import a certificate from an existed certificate file, or directly paste a PEM encoded string as the certificate.

The screenshot shows a user interface for importing certificates. It features two tabs: 'Import' and 'PEM Encoded'. The 'Import' tab is currently selected and contains a '瀏覽...' (Browse...) button and the text '未選擇檔案。' (No file selected). The 'PEM Encoded' tab is also visible and contains 'Apply' and 'Cancel' buttons. Below the tabs is a large empty text area for pasting PEM encoded strings.

Import Item	Value setting	Description
Import	A Must filled setting	Select a certificate file from user's computer, and click the Apply button to import the specified certificate file to the gateway.
PEM Encoded	1. String format can be any text 2. A Must filled setting	This is an alternative approach to import a certificate. You can directly fill in (Copy and Paste) the PEM encoded certificate string, and click the Apply button to import the specified certificate to the gateway.
Apply	N/A	Click the Apply button to import the certificate.
Cancel	N/A	Click the Cancel button to discard the import operation and the screen will return to the My Certificates page.

4G IIoT LoRa Gateway

3.5.3 Trusted Certificate

Trusted Certificate includes Trusted CA Certificate List, Trusted Client Certificate List, and Trusted Client Key List. The Trusted CA Certificate List places the certificates of external trusted CAs. The Trusted Client Certificate List places the others' certificates what you trust. And the Trusted Client Key List places the others' keys what you trusted.

Self-signed Certificate Usage Scenario

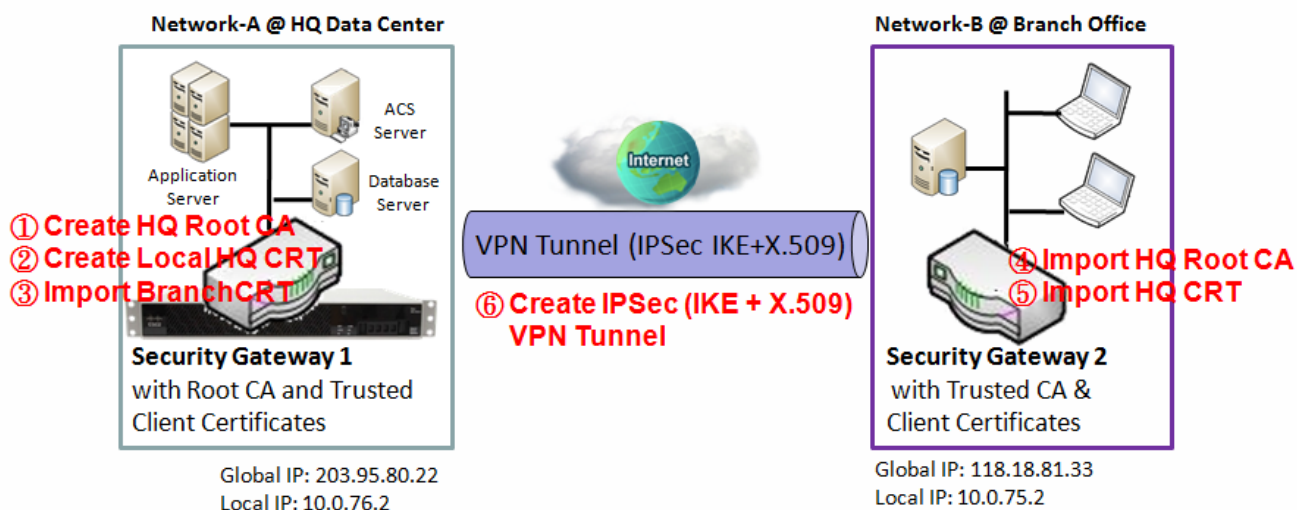

Scenario Application Timing (same as the one described in "My Certificate" section)

When the enterprise gateway owns the root CA and VPN tunneling function, it can generate its own local certificates by being signed by itself. Also imports the trusted certificates for other CAs and Clients. These certificates can be used for two remote peers to make sure their identity during establishing a VPN tunnel.

Scenario Description (same as the one described in "My Certificate" section)

Gateway 1 generates the root CA and a local certificate (HQCRT) signed by itself. Import a trusted certificate (BranchCRT) –a BranchCSR certificate of Gateway 2 signed by root CA of Gateway 1.

Gateway 2 creates a CSR (BranchCSR) to let the root CA of the Gateway 1 sign it to be the BranchCRT certificate. Import the certificate into the Gateway 2 as a local certificate. In addition, also imports the certificates of the root CA of Gateway 1 into the Gateway 2 as the trusted ones. (Please also refer to "My Certificate" and "Issue Certificate" sections).

Establish an IPSec VPN tunnel with IKE and X.509 protocols by starting from either peer, so that all client hosts in these both subnets can communicate with each other.

Parameter Setup Example (same as the one described in "My Certificate" section)

4G IIoT LoRa Gateway

For Network-A at HQ

Following tables list the parameter configuration as an example for the "Trusted Certificate" function used in the user authentication of IPSec VPN tunnel establishing, as shown in above diagram. The configuration example must be combined with the ones in "My Certificate" and "Issue Certificate" sections to complete the setup for the whole user scenario.

Configuration Path	[Trusted Certificate]-[Trusted Client Certificate List]
Command Button	<i>Import</i>

Configuration Path	[Trusted Certificate]-[Trusted Client Certificate Import from a File]
File	<i>BranchCRT.crt</i>

For Network-B at Branch Office

Following tables list the parameter configuration as an example for the "Trusted Certificate" function used in the user authentication of IPSec VPN tunnel establishing, as shown in above diagram. The configuration example must be combined with the ones in "My Certificate" and "Issued Certificate" sections to complete the setup for the whole user scenario.

Configuration Path	[Trusted Certificate]-[Trusted CA Certificate List]
Command Button	<i>Import</i>

Configuration Path	[Trusted Certificate]-[Trusted CA Certificate Import from a File]
File	<i>HQRootCA.crt</i>

Configuration Path	[Trusted Certificate]-[Trusted Client Certificate List]
Command Button	<i>Import</i>

Configuration Path	[Trusted Certificate]-[Trusted Client Certificate Import from a File]
File	<i>HQCRT.crt</i>

Scenario Operation Procedure (same as the one described in "My Certificate" section)

In above diagram, the "Gateway 1" is the gateway of Network-A in headquarters and the subnet of its Intranet is 10.0.76.0/24. It has the IP address of 10.0.76.2 for LAN interface and 203.95.80.22 for WAN-1 interface. The "Gateway 2" is the gateway of Network-B in branch office and the subnet of its Intranet is 10.0.75.0/24. It has the IP address of 10.0.75.2 for LAN interface and 118.18.81.33 for WAN-1 interface. They both serve as the NAT security gateways.

In Gateway 2 import the certificates of the root CA and HQCRT that were generated and signed by Gateway 1 into the "Trusted CA Certificate List" and "Trusted Client Certificate List" of Gateway 2.

4G IIoT LoRa Gateway

Import the obtained BranchCRT certificate (the derived BranchCSR certificate after Gateway 1's root CA signature) into the "Trusted Client Certificate List" of the Gateway 1 and the "Local Certificate List" of the Gateway 2. For more details, refer to the Network-B operation procedure in "My Certificate" section of this manual.

Gateway 2 can establish an IPSec VPN tunnel with "Site to Site" scenario and IKE and X.509 protocols to Gateway 1.

Finally, the client hosts in two subnets of 10.0.75.0/24 and 10.0.76.0/24 can communicate with each other.

4G IIoT LoRa Gateway

Trusted Certificate Setting

Go to **Object Definition > Certificate > Trusted Certificate** tab.

The Trusted Certificate setting allows user to import trusted certificates and keys.

Import Trusted CA Certificate

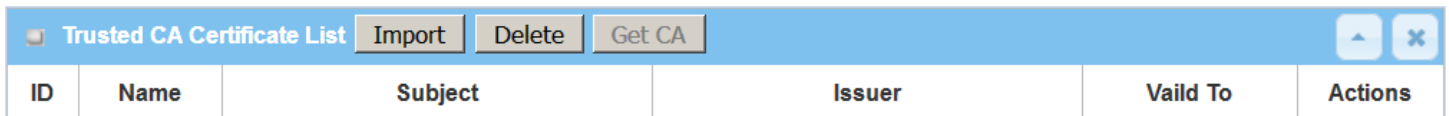

ID	Name	Subject	Issuer	Valid To	Actions
----	------	---------	--------	----------	---------

When **Import** button is applied, a **Trusted CA import** screen will appear. You can import a Trusted CA certificate from an existed certificate file, or directly paste a PEM encoded string as the certificate.

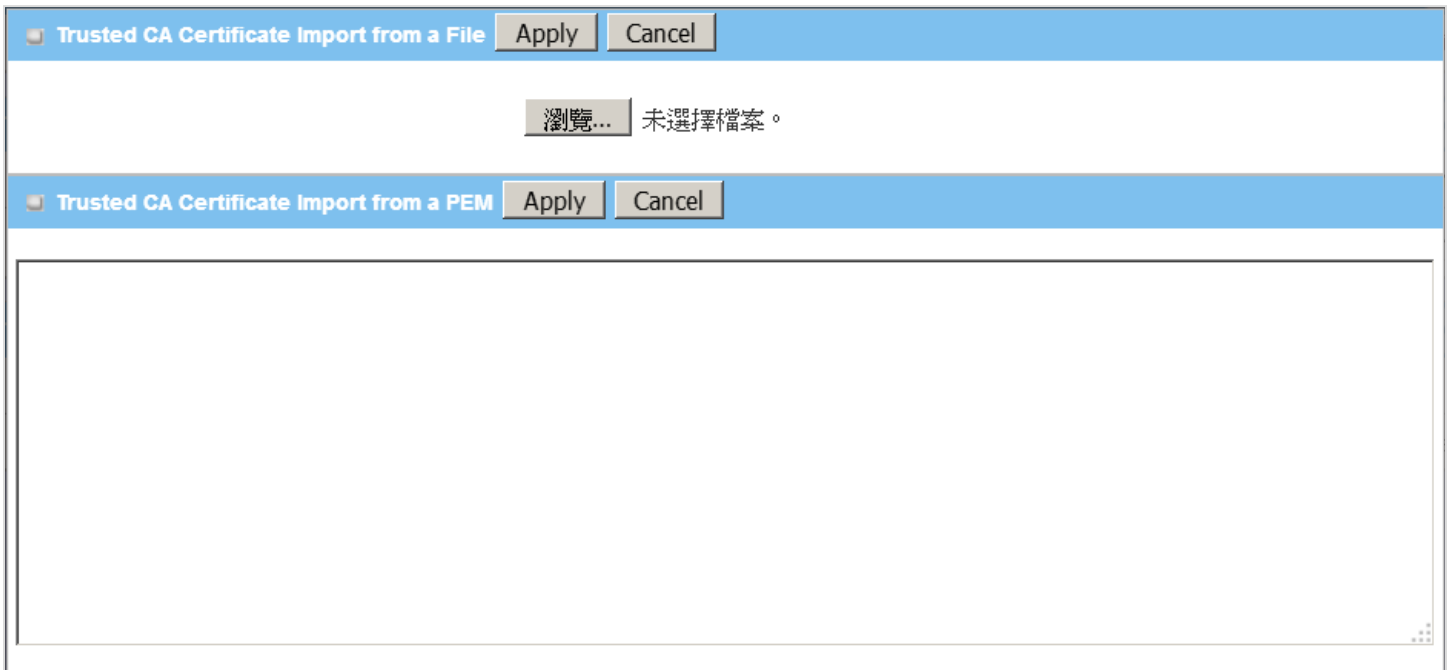

Trusted CA Certificate List		
Item	Value setting	Description
Import from a File	A Must filled setting	Select a CA certificate file from user's computer, and click the Apply button to import the specified CA certificate file to the gateway.
Import from a PEM	1. String format can be any text 2. A Must filled setting	This is an alternative approach to import a CA certificate. You can directly fill in (Copy and Paste) the PEM encoded CA certificate string, and click the Apply button to import the specified CA certificate to the gateway.
Apply	N/A	Click the Apply button to import the certificate.
Cancel	N/A	Click the Cancel button to discard the import operation and the screen will return to the Trusted Certificates page.

4G IIoT LoRa Gateway

Instead of importing a Trusted CA certificate with mentioned approaches, you can also get the CA certificate from the SECP server.

If **SCEP** is enabled (Refer to **Object Definition > Certificate > Configuration**), you can click **Get CA** button, a Get CA Configuration screen will appear.

Get CA Configuration	
Item	Setting
▶ SCEP Server	<input type="text" value="--- Option ---"/> <input type="button" value="Add Object"/>
▶ CA Identifier	<input type="text"/> (Optional)

Get CA Configuration		
Item	Value setting	Description
SCEP Server	A Must filled setting	Select a SCEP Server to identify the SCEP server for use. The server detailed information could be specified in External Servers. Refer to Object Definition > External Server > External Server . You may click Add Object button to generate.
CA Identifier	1. String format can be any text	Fill in optional CA Identifier to identify which CA could be used for signing certificates.
Save	N/A	Click Save to save the settings.
Close	N/A	Click the Close button to return to the Trusted Certificates page.

Import Trusted Client Certificate

Trusted Client Certificate List					
ID	Name	Subject	Issuer	Vaild To	Actions
					<input type="button" value="Import"/> <input type="button" value="Delete"/>

When **Import** button is applied, a **Trusted Client Certificate Import** screen will appear. You can import a Trusted Client Certificate from an existed certificate file, or directly paste a PEM encoded string as the certificate.

4G IIoT LoRa Gateway

Trusted Client Certificate Import from a File

未選擇檔案。

Trusted Client Certificate Import from a PEM

Item	Value setting	Description
Import from a File	A Must filled setting	Select a certificate file from user's computer, and click the Apply button to import the specified certificate file to the gateway.
Import from a PEM	1. String format can be any text 2. A Must filled setting	This is an alternative approach to import a certificate. You can directly fill in (Copy and Paste) the PEM encoded certificate string, and click the Apply button to import the specified certificate to the gateway.
Apply	N/A	Click the Apply button to import certificate.
Cancel	N/A	Click the Cancel button to discard the import operation and the screen will return to the Trusted Certificates page.

Import Trusted Client Key

Trusted Client Key List

ID	Name	Actions
----	------	---------

When **Import** button is applied, a **Trusted Client Key Import** screen will appear. You can import a Trusted Client Key from an existed file, or directly paste a PEM encoded string as the key.

4G IIoT LoRa Gateway

Trusted Client Key Import from a File

未選擇檔案。

Trusted Client Key Import from a PEM

Trusted Client Key List		
Item	Value setting	Description
Import from a File	A Must filled setting	Select a certificate key file from user's computer, and click the Apply button to import the specified key file to the gateway.
Import from a PEM	1. String format can be any text 2. A Must filled setting	This is an alternative approach to import a certificate key. You can directly fill in (Copy and Paste) the PEM encoded certificate key string, and click the Apply button to import the specified certificate key to the gateway.
Apply	N/A	Click the Apply button to import the certificate key.
Cancel	N/A	Click the Cancel button to discard the import operation and the screen will return to the Trusted Certificates page.

4G IIoT LoRa Gateway

3.5.4 Issue Certificate

When you have a Certificate Signing Request (CSR) that needs to be certificated by the root CA of the device, you can issue the request here and let Root CA sign it. There are two approaches to issue a certificate. One is from a CSR file importing from the managing PC and another is copy-paste the CSR codes in gateway's web-based utility, and then click on the "Sign" button.

If the gateway signs a CSR successfully, the "Signed Certificate View" window will show the resulted certificate contents. In addition, a "Download" button is available for you to download the certificate to a file in the managing PC.

Self-signed Certificate Usage Scenario

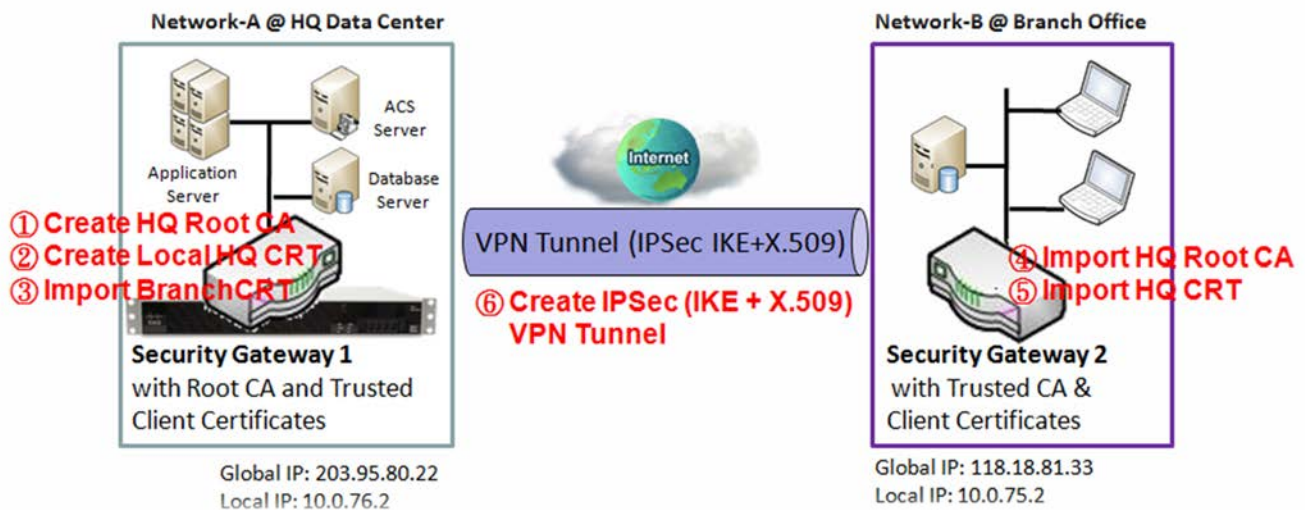

Scenario Application Timing (same as the one described in "My Certificate" section)

When the enterprise gateway owns the root CA and VPN tunneling function, it can generate its own local certificates by being signed by itself. Also imports the trusted certificates for other CAs and Clients. These certificates can be used for two remote peers to make sure their identity during establishing a VPN tunnel.

Scenario Description (same as the one described in "My Certificate" section)

Gateway 1 generates the root CA and a local certificate (HQCRT) signed by itself. Also imports a trusted certificate (BranchCRT) –a BranchCSR certificate of Gateway 2 signed by root CA of Gateway 1.

Gateway 2 creates a CSR (BranchCSR) to let the root CA of the Gateway 1 sign it to be the BranchCRT certificate. Import the certificate into the Gateway 2 as a local certificate. In addition, also imports the certificates of the root CA of the Gateway 1 into the Gateway 2 as the trusted ones. (Please also refer

4G IIoT LoRa Gateway

to "My Certificate" and "Trusted Certificate" sections).

Establish an IPSec VPN tunnel with IKE and X.509 protocols by starting from either peer, so that all client hosts in these both subnets can communicate with each other.

Parameter Setup Example (same as the one described in "My Certificate" section)

For Network-A at HQ

Following tables list the parameter configuration as an example for the "Issue Certificate" function used in the user authentication of IPSec VPN tunnel establishing, as shown in above diagram. The configuration example must be combined with the ones in "My Certificate" and "Trusted Certificate" sections to complete the setup for whole user scenario.

Configuration Path	[Issue Certificate]-[Certificate Signing Request Import from a File]
Browse	<i>C:/BranchCSR</i>
Command Button	<i>Sign</i>

Configuration Path	[Issue Certificate]-[Signed Certificate View]
Command Button	<i>Download</i> (default name is "issued.crt")

Scenario Operation Procedure (same as the one described in "My Certificate" section)

In above diagram, the "Gateway 1" is the gateway of Network-A in headquarters and the subnet of its Intranet is 10.0.76.0/24. It has the IP address of 10.0.76.2 for LAN interface and 203.95.80.22 for WAN-1 interface. The "Gateway 2" is the gateway of Network-B in branch office and the subnet of its Intranet is 10.0.75.0/24. It has the IP address of 10.0.75.2 for LAN interface and 118.18.81.33 for WAN-1 interface. They both serve as the NAT security gateways.

Gateway 1 generates the root CA and a local certificate (HQCRT) that is signed by itself. Import the certificates of the root CA and HQCRT into the "Trusted CA Certificate List" and "Trusted Client Certificate List" of Gateway 2.

Gateway 2 generates a Certificate Signing Request (BranchCSR) for its own certificate BranchCRT to be signed by root CA (Please generate one not self-signed certificate in the Gateway 2, and click on the "View" button for that CSR. Just downloads it). Take the CSR to be signed by the root CA of the Gateway 1 and obtain the BranchCRT certificate (you need rename it). Import the certificate into the "Trusted Client Certificate List" of the Gateway 1 and the "Local Certificate List" of the Gateway 2.

Gateway 2 can establish an IPSec VPN tunnel with "Site to Site" scenario and IKE and X.509 protocols to Gateway 1.

Finally, the client hosts in two subnets of 10.0.75.0/24 and 10.0.76.0/24 can communicate with each other.

4G IIoT LoRa Gateway

Issue Certificate Setting

Go to **Object Definition > Certificate > Issue Certificate** tab.

The Issue Certificate setting allows user to import Certificate Signing Request (CSR) to be signed by root CA.

Import and Issue Certificate

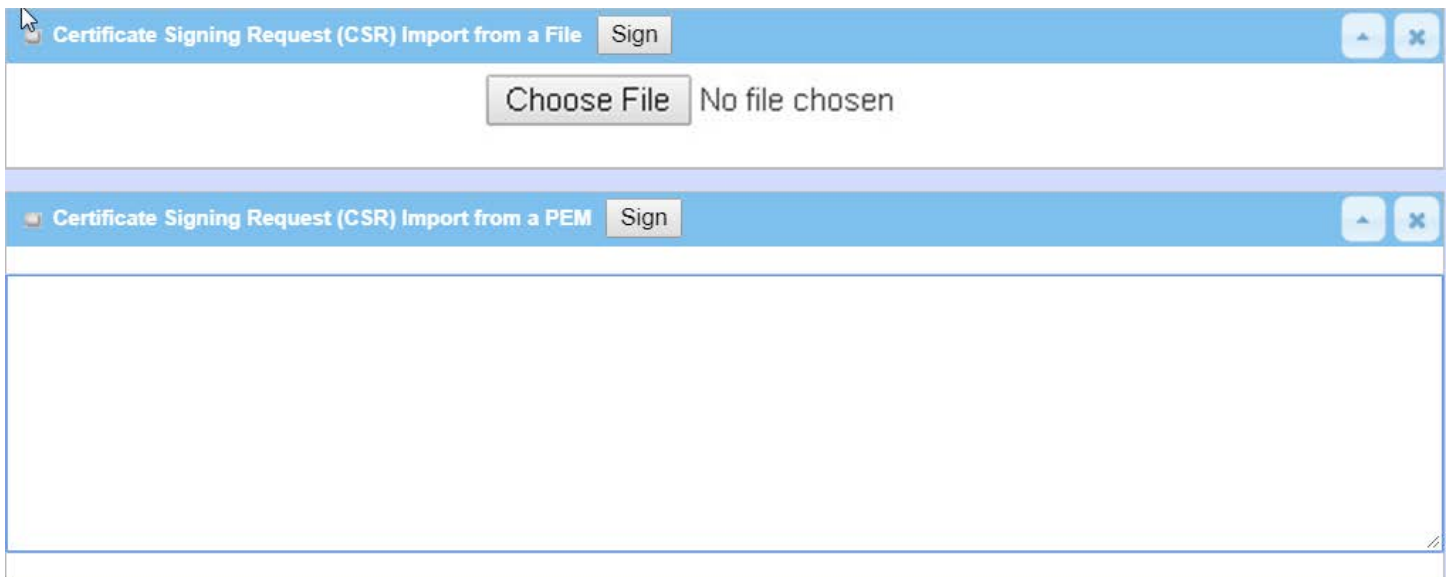

Certificate Signing Request (CSR) Import from a File		
Item	Value setting	Description
Certificate Signing Request (CSR) Import from a File	A Must filled setting	Select a certificate signing request file you're your computer for importing to the gateway.
Certificate Signing Request (CSR) Import from a PEM	1. String format can be any text 2. A Must filled setting	Enter (copy-paste) the certificate signing request PEM encoded certificate to the gateway.
Sign	N/A	When root CA is exist, click the Sign button sign and issue the imported certificate by root CA.

Chapter 4 Field Communication

4.1 Bus & Protocol

The gateway may equip one or more serial port(s) for various serial communication use through connecting the RS-232 or RS-485 serial devices to an IP-based Ethernet LAN. These communication protocols make user access serial devices anywhere over a local LAN or the Internet easily. They can be "Virtual COM" and "Modbus".

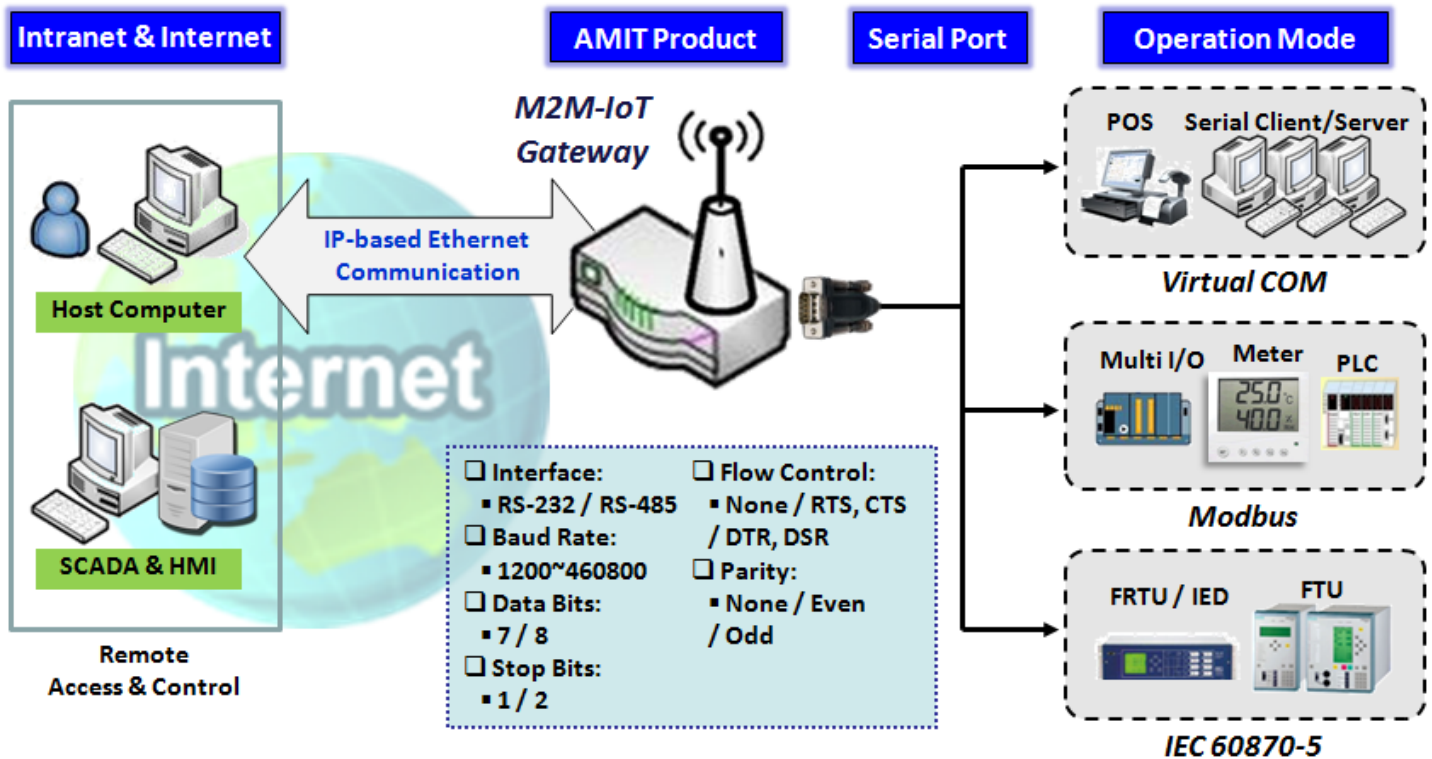

4.1.1 Port Configuration

Before using the supported field communication function, like Virtual COM or Modbus, you need to configure the physical communication port first.

The port configuration screen allows user to configure the operation mode and physical layer settings for each serial interface, and also can quick switch from one communication protocol to another for the serial port. The number of ports and type of the supported protocols could be different for the purchased gateway model.

4G IIoT LoRa Gateway

Port Configuration Setting

Go to **Field Communication > Bus & Protocol > Port Configuration** tab.

In "Port Configuration" page, there is only one configuration window for the serial port settings. The "Configuration" window can let you specify serial port parameters including the operation mode being "Virtual COM", "Modbus" or disabled, the interface, the baud rate, the data bit length, the stop bit length, the flow control being "RTS/CTS", "DTS/DSR" or "None", and the parity.

Serial Port Definition								
Serial Port	Operation Mode	Interface	Baud Rate	Data Bits	Stop Bits	Flow Control	Parity	Action
SPort-0	Disable	RS-232	9600	8	1	None	None	Edit

Port Configuration Window		
Item	Value setting	Description
Serial Port	N/A	It displays the serial port ID of the serial port. The number of serial ports varies from the purchased model.
Operation Mode	Disable is set by default	Select the operation mode for the serial interface. The available modes can be Disable, Virtual COM or Modbus.
Interface	RS-232 is set by default	Select the physical interface type for connecting to the access device(s) with the same interface specification. Depending on the purchase model, the supported interface type could be RS-232 or RS-485.
Baud Rate	9600 is set by default	Select the appropriate baud rate for serial device communication. RS-232: 1200 / 2400 / 4800 / 9600 / 19200 / 38400 / 57600 / 115200 RS-485 can use higher baud rate for 230400 and 460800. It depends on the cable length and the installed environment. The longer cable, the lower baud rate for it.
Data Bits	8 is set by default	Select 8 or 7 for data bits.
Stop Bits	1 is set by default	Select 1 or 2 for stop bits.
Flow Control	None is set by default	Select None / RTS, CTS / DTS, DSR for Flow Control in RS-232 mode. The supporting of Flow Control depends on the purchased model.
Parity	None is set by default	Select None / Even / Odd for Parity bit.
Action	N/A	Click Edit button to change the operation mode, or modify the parameters mentioned above for the serial interface communication.
Save	N/A	Click Save button to save the settings.
Undo	N/A	Click Undo button to cancel the settings.

4G IIoT LoRa Gateway

4.1.2 Virtual COM

Create a virtual COM port on user's PC/Host to provide access to serial device connected to the serial port on gateway. Therefore, users can access, control, and manage the connected serial device through Internet (fixed line, or cellular network) anywhere. This application is also known as Ethernet pass-through communication.

Operation Mode Definition for each Serial Port									
Serial Port	Operation Mode	Listen Port	Trust Type	Max Connection	Connection Control	Connection Idle Timeout	Alive Check Timeout	Enable	Action
SPort-0	Disable	N/A	N/A	N/A	N/A	N/A	N/A	<input type="checkbox"/>	Edit

Virtual COM setting screen enables user to connect a Virtual COM port based device to the Internet. It allows user to access serial data remotely. There are Disable, TCP Client, TCP Server, UDP, and RFC2217 modes for remote accessing the connected serial device. These operation modes are illustrated as below.

TCP Client Mode

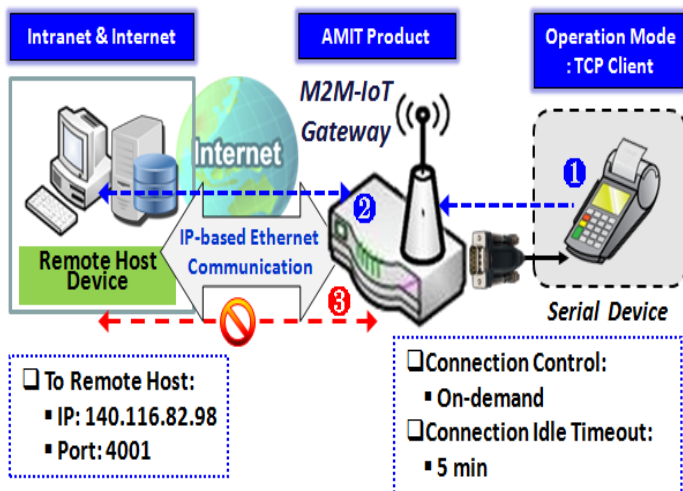

- ① Gateway get Data received from Serial Device.
- ② Establish a TCP Connection and Transmit Data to Remote Host.
- ③ Terminate this TCP Connection once Idle Timeout reached 5 mins.

When the administrator expects the gateway to actively establish a TCP connection to a pre-defined host computer when serial data arrives, the operation mode for the "Virtual COM" function is required to be "TCP Client" and when the connection control of virtual COM is "On-demand", once the gateway receives data from the connected serial device, it will establish a TCP connection to transfer the received serial data to the remote host. Besides, after the data has been transferred, the gateway automatically disconnects the established TCP session from the host computer by using the TCP alive check timeout or idle timeout settings.

4G IIoT LoRa Gateway

TCP Server Mode

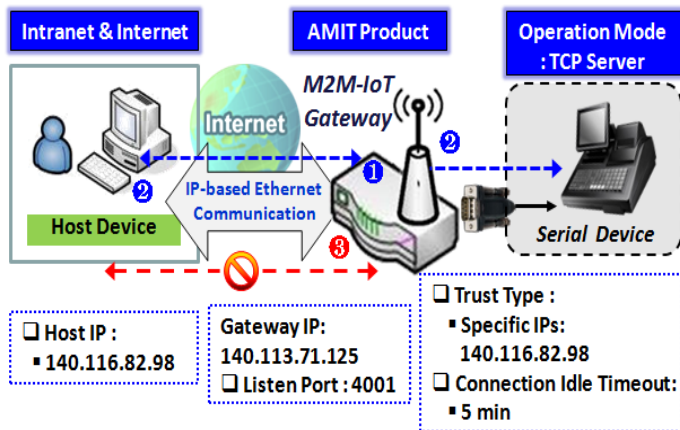

- ① Gateway remain Listening and Host will Establish a TCP Connection with it.
- ② Host Send Data then Gateway Transmit it to the Serial Device.
- ③ Terminate this TCP Connection once Idle Timeout reached 5 mins.

When the administrator expects the gateway to wait passively for the serial data requests from the Host Device (usually we use a computer to play as a Host), and the Host will establish a TCP connection to get data from the serial device, the operation mode for the "Virtual COM" function is required to be "TCP Server". In this mode, the gateway provides a unique "IP: Port" address on a TCP/IP network. It supports up to 4 simultaneous connections, so that multiple hosts can collect data from the same serial device at the same time. After the data has been transferred, the TCP connection will be automatically disconnected from the host computer by using the TCP alive check timeout or idle timeout settings.

UDP Mode

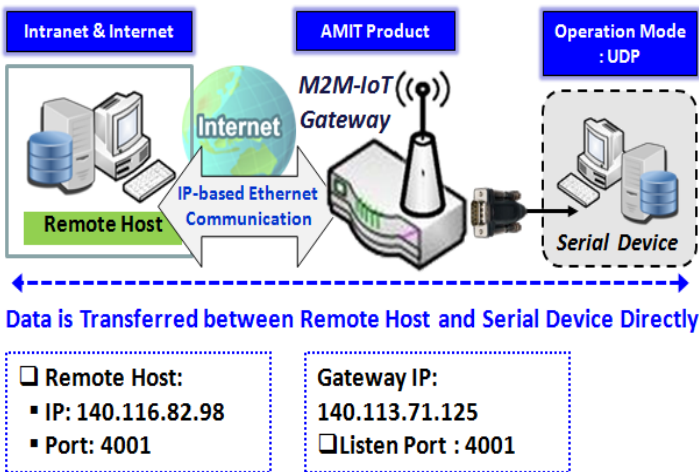

Data is Transferred between Remote Host and Serial Device Directly

If both the Remote Host Computer and the serial device are expected to initiate a data transfer when it requires doing that, the operation mode for the "Virtual COM" function in the gateway is required to be "UDP". In this mode, the UDP data can be transferred between the gateway and multiple host computers from either peer, making this mode ideal for message display applications.

The remote host computer can directly send UDP data to the serial device via the gateway, and also receive UDP data from the serial device via the gateway at the same time. The gateway supports up to 4 legal hosts to connect simultaneously to the serial device via the gateway.

4G IIoT LoRa Gateway

RFC-2217 Mode

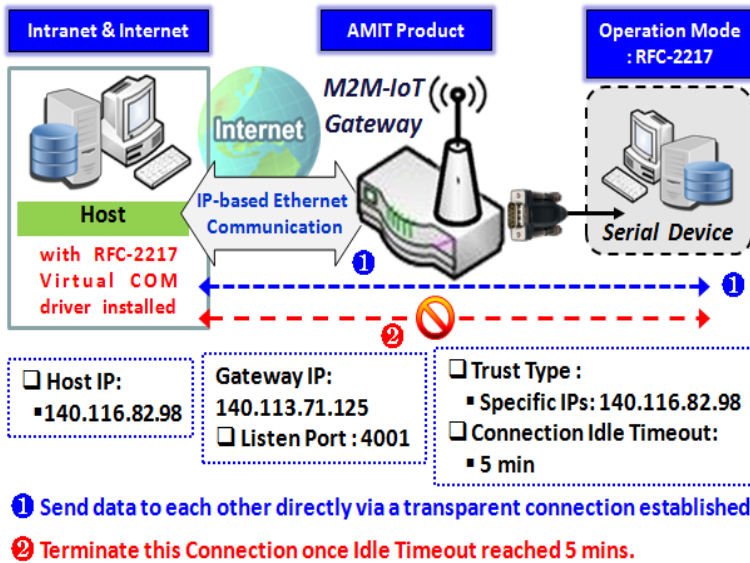

RFC-2217 defines general COM port control options based on telnet protocol. A host computer with RFC-2217 driver installed can monitor and manage the remote serial device attached to the gateway's serial port, as though they were connected to the local serial port. When a virtual serial port on the local serial device is being created, it is required to specify the IP-address of the host computers to establish connection with.

Any 3rd party driver supporting RFC2217 can be used to install in the host computer, the driver establishes a transparent connection between host and serial device by mapping the IP:Port of the gateway's serial port to a virtual local COM

port on the host computer.

The host computer can directly send data to the serial device via the gateway, and also receive data from the serial device via the gateway at the same time. The gateway supports up to 4 Internet host computers.

4G IIoT LoRa Gateway

Virtual COM Setting

Virtual COM setting screen enables user to connect a Virtual COM port based device to the Internet. It allows user to access serial data remotely. There are Disable, TCP Client, TCP Server, UDP, and RFC2217 modes for remote accessing the connected serial device. By default, it is configured in Disable mode.

To use the Virtual COM function, you have to specify the operation mode for the multi-function serial port first. Go to **Field Communication > Bus & Protocol > Port Configuration** tab, select the Virtual COM as expected operation mode, and finish the related port configuration as well.

After that, go to **Field Communication > Bus & Protocol > Virtual COM** tab for detailed configuration of Virtual COM setting.

Enable TCP Client Mode

Configure the gateway as the TCP (Transmission Control Protocol) Client. In TCP Client mode, device initiates a TCP connection with a TCP server when there is data to transmit. Device disconnects from the server when the connection is Idle for a specified period. You may also enable full time connection with the TCP server.

Operation Mode Definition for each Serial Port									
Serial Port	Operation Mode	Listen Port	Trust Type	Max Connection	Connection Control	Connection Idle Timeout	Alive Check Timeout	Enable	Action
SPort-0	TCP Client	4001 (1~65535)	Allow All	1	Always on	0 (0-3600secs)	0 (0-3600secs)	<input type="checkbox"/>	Edit

Enable TCP Client Mode Window		
Item	Value setting	Description
Operation Mode	A Must filled setting	Select TCP Client .
Connection Control	Always on is set by default	Choose Always on for a TCP full time connection. Otherwise, choose On-Demand to initiate TCP connection only when required to transmit and disconnect at idle timeout.
Connection Idle Timeout	1. 0 is set by default 2. Range 0 to 3600 sec.	Enter the idle timeout in minutes. The idle timeout is used to disconnect the TCP connection when idle time elapsed . Idle timeout is only available when On-Demand is selected in the Connection Control field. Value Range: 0 ~ 3600 seconds.
Alive Check Timeout	1. 0 is set by default 2. Range 0 to 3600 sec.	Enter the time period of alive check timeout. The TCP connection will be terminated if it doesn't receive response of alive-check longer than this timeout setting Alive check timeout is only available when On-Demand is selected in the Connection Control field. Value Range: 0 ~ 3600 seconds.
Enable	The box is unchecked by default.	Check the Enable box to activate the corresponding serial port in specified operation mode.
Save	N/A	Click the Save button to save the configuration

4G IIoT LoRa Gateway

Specify Data Packing Parameters

Data Packing (for TCP Client, TCP Server and UDP operation mode)				
Serial Port	Data Buffer Length	Delimiter Character 1	Delimiter Character 2	Data Timeout Transmit
SPort-0	<input type="text" value="0"/> (0~1024)	<input type="text" value="0"/> (Hex) <input type="checkbox"/> Enable	<input type="text" value="0"/> (Hex) <input type="checkbox"/> Enable	<input type="text" value="0"/> (0~1000ms)

Data Packing Configuration		
Item	Value setting	Description
Data Buffer Length	1.An optional filled setting 2.Default value is 0	Enter the data buffer length for the serial port. Value Range: 0 ~ 1024.
Delimiter Character 1	1.An optional filled setting 2.Default value is 0	Check the Enable box to activate the Delimiter character 1, and enter the Hex code for it. Value Range: 0x00 ~ 0xFF.
Delimiter Character 2	1.An optional filled setting 2.Default value is 0	Check the Enable box to activate the Delimiter character 2, and enter the Hex code for it. Value Range: 0x00 ~ 0xFF.
Data Timeout Transmit	1.An optional filled setting 2.Default value is 0	Enter the data timeout interval for transmitting serial data through the port. By default, it is set to 0 and the timeout function is disabled. Value Range: 0 ~ 1000ms.
Save	N/A	Click the Save button to save the configuration

Specify Remote TCP Server

Legal Host IP/ FQDN Definition (for TCP Client operation mode)					
ID	To Remote Host	Remote Port	Serial Port	Definition Enable	Action
1		4001	SPort-0	<input type="checkbox"/>	<input type="button" value="Edit"/>
2		4001	SPort-0	<input type="checkbox"/>	<input type="button" value="Edit"/>
3		4001	SPort-0	<input type="checkbox"/>	<input type="button" value="Edit"/>
4		4001	SPort-0	<input type="checkbox"/>	<input type="button" value="Edit"/>

Specify TCP Server Window		
Item	Value setting	Description
To Remote Host	A Must filled setting	Press Edit button to enter IP address or FQDN of the remote TCP server to transmit serial data.
Remote Port	1.A Must filled setting 2.Default value is 4001	Enter the TCP port number. This is the listen port of the remote TCP server. Value Range: 1 ~ 65535.
Serial Port	SPort-0 is set by default	Apply the TCP server connection for a selected serial port. Up to 4 TCP servers can be configured at the same time for each serial port.
Definition Enable	The box is unchecked by default	Check the Enable box to enable the TCP server configuration.
Save	N/A	Click the Save button to save the configuration

4G IIoT LoRa Gateway

Enable TCP Server Mode

Configure the gateway as the TCP (Transmission Control Protocol) Server. The TCP Server waits for connections to be initiated by a remote TCP client device to receive serial data. The setting allows user to specify specific TCP clients or allow any to send serial data for serial data transmission bandwidth control and access control. The TCP Server supports up to 128 simultaneous connections to receive serial data from multiple TCP clients.

Operation Mode Definition for each Serial Port									
Serial Port	Operation Mode	Listen Port	Trust Type	Max Connection	Connection Control	Connection Idle Timeout	Alive Check Timeout	Enable	Action
SPort-0	TCP Server ▼	4001 (1~65535)	Allow All ▼	1	Always on ▼	0 (0-3600secs)	0 (0-3600secs)	<input type="checkbox"/>	Edit

Enable TCP Server Mode Window		
Item	Value setting	Description
Operation Mode	A Must filled setting	Select TCP Server mode.
Listen Port	4001 is set by default	Indicate the listening port of TCP connection. Value Range: 1 ~ 65535.
Trust Type	Allow All is set by default	Choose Allow All to allow any TCP clients to connect. Otherwise choose Specific IP to limit certain TCP clients.
Max Connection	1. Max. 128 connections 2. 1 is set by default	Set the maximum number of concurrent TCP connections. Up to 128 simultaneous TCP connections can be established. Value Range: 1 ~ 128.
Connection Idle Timeout	1. 0 is set by default 2. Range 0 to 3600 sec.	Enter the idle timeout in minutes. The idle timeout is used to disconnect the TCP connection when idle time elapsed . Idle timeout is only available when On-Demand is selected in the Connection Control field. Value Range: 0 ~ 3600 seconds.
Alive Check Timeout	1. 0 is set by default 2. Range 0 to 3600 sec.	Enter the time period of alive check timeout. The TCP connection will be terminated if it doesn't receive response of alive-check longer than this timeout setting Alive check timeout is only available when On-Demand is selected in the Connection Control field. Value Range: 0 ~ 3600 seconds.
Enable	The box is unchecked by default.	Check the Enable box to activate the corresponding serial port in specified operation mode.
Save	N/A	Click Save button to save the settings.

4G IIoT LoRa Gateway

Specify TCP Clients for TCP Server Access

If you selected **Specific IPs** as the trust Type, the Trusted IP Definition window appears. The settings are valid for both TCP Server and RFC-2217 modes.

Trusted IP Definition (for TCP Server & RFC-2217 operation mode)				
ID	Host	Serial Port	Definition Enable	Action
1			<input type="checkbox"/>	Edit
2			<input type="checkbox"/>	Edit
3			<input type="checkbox"/>	Edit
4			<input type="checkbox"/>	Edit
5			<input type="checkbox"/>	Edit
6			<input type="checkbox"/>	Edit
7			<input type="checkbox"/>	Edit
8			<input type="checkbox"/>	Edit

Specify TCP Clients Window		
Item	Value setting	Description
Host	A Must filled setting	Enter the IP address range of allowed TCP clients.
Serial Port	The box is unchecked by default	Check the box to specify the rule for selected Serial Port.
Definition Enable	The box is unchecked by default	Check the Enable box to enable the rule.
Save	N/A	Click Save to save the settings
Undo	N/A	Click Undo to cancel the settings

4G IIoT LoRa Gateway

Enable UDP Mode

UDP (User Datagram Protocol) enables applications using UDP socket programs to communicate with the serial ports on the serial server. The UDP mode provides connectionless communications, which enable you to multicast data from the serial device to multiple host computers, and vice versa, making this mode ideal for message display applications.

Operation Mode Definition for each Serial Port									
Serial Port	Operation Mode	Listen Port	Trust Type	Max Connection	Connection Control	Connection Idle Timeout	Alive Check Timeout	Enable	Action
SPort-0	UDP	4001 (1~65535)	Allow All	1	Always on	0 (0-3600secs)	0 (0-3600secs)	<input type="checkbox"/>	Edit

Enable UDP Mode Window		
Item	Value setting	Description
Operation Mode	A Must filled setting	Select UDP mode.
Listen Port	4001 is set by default	Indicate the listening port of UDP connection. Value Range: 1 ~ 65535
Enable	The box is unchecked by default.	Check the Enable box to activate the corresponding serial port in specified operation mode.
Save	N/A	Click Save to save the settings
Undo	N/A	Click Undo to cancel the settings

Specify Remote UDP

Legal Host IP Definition (for UDP operation mode)					
ID	Remote Host	Remote Port	Serial Port	Definition Enable	Action
1		4001	SPort-0	<input type="checkbox"/>	Edit
2		4001	SPort-0	<input type="checkbox"/>	Edit
3		4001	SPort-0	<input type="checkbox"/>	Edit
4		4001	SPort-0	<input type="checkbox"/>	Edit

Specify Remote UDP hosts Window		
Item	Value setting	Description
Host	A Must filled setting	Press Edit button to enter IP address range of remote UDP hosts.
Remote Port	4001 is set by default	Indicate the UDP port of peer UDP hosts. Value Range: 1 ~ 65535
Serial Port	SPort-0 is set by default	Apply the UDP hosts for a selected serial port. Up to 4 UDP servers can be configured at the same time for each serial port.
Definition Enable	The box is unchecked by default	Check the Enable box to enable the rule.
Save	N/A	Click Save to save the settings
Undo	N/A	Click Undo to cancel the settings

4G IIoT LoRa Gateway

Enable RFC-2217 Mode

RFC-2217 defines general COM port control options based on telnet protocol. With the RFC-2217 mode, remote host can monitor and manage remote serially attached devices, as though they were connected to the local serial port. When a virtual serial port on the local serial device is being created, it is required to specify the IP-address of the remote hosts to establish connection with.

Operation Mode Definition for each Serial Port									
Serial Port	Operation Mode	Listen Port	Trust Type	Max Connection	Connection Control	Connection Idle Timeout	Alive Check Timeout	Enable	Action
SPort-0	RFC-2217 ▼	4001 (1~65535)	Allow All ▼	1	Always on ▼	0 (0-3600secs)	0 (0-3600secs)	<input type="checkbox"/>	Edit

Enable RFC-2217 Mode Window		
Item	Value setting	Description
Operation Mode	A Must filled setting	Select RFC-2217 mode.
Listen Port	4001 is set by default	Indicate the listening port of RFC-2217 connection. Value Range: 1 ~ 65535
Trust Type	Allow All is set by default	Choose Allow All to allow any clients to connect. Otherwise choose Specific IP to limit certain clients.
Connection Idle Timeout	1. 0 is set by default 2. Range 0 to 3600 sec.	Enter the idle timeout in minutes. The idle timeout is used to disconnect the TCP connection when idle time elapsed . Idle timeout is only available when On-Demand is selected in the Connection Control field. Value Range: 0 ~ 3600 seconds.
Alive Check Timeout	1. 0 is set by default 2. Range 0 to 3600 sec.	Enter the time period of alive check timeout. The TCP connection will be terminated if it doesn't receive response of alive-check longer than this timeout setting Alive check timeout is only available when On-Demand is selected in the Connection Control field. Value Range: 0 ~ 3600 seconds.
Enable	The box is unchecked by default.	Check the Enable box to activate the corresponding serial port in specified operation mode.
Save	N/A	Click Save to save the settings
Undo	N/A	Click Undo to cancel the settings

4G IIoT LoRa Gateway

Specify Remote Host for Access

If you selected **Specific IPs** as the trust Type, the Trusted IP Definition window appears. The settings are valid for both TCP Server and RFC-2217 modes.

Trusted IP Definition (for TCP Server & RFC-2217 operation mode)				
ID	Host	Serial Port	Definition Enable	Action
1			<input type="checkbox"/>	Edit
2			<input type="checkbox"/>	Edit
3			<input type="checkbox"/>	Edit
4			<input type="checkbox"/>	Edit
5			<input type="checkbox"/>	Edit
6			<input type="checkbox"/>	Edit
7			<input type="checkbox"/>	Edit
8			<input type="checkbox"/>	Edit

Specify RFC-2217 Clients for Access Window		
Item	Value setting	Description
Host	A Must filled setting	Enter the IP address range of allowed clients.
Serial Port	The box is unchecked by default	Check the box to specify the rule for selected Serial Port.
Definition Enable	The box is unchecked by default	Check the Enable box to enable the rule.
Save	N/A	Click Save to save the settings
Undo	N/A	Click Undo to cancel the settings

4G IIoT LoRa Gateway

4.1.3 Modbus

Modbus is one of the most popular automation protocols in the world, supporting traditional RS-232/422/485 devices and recently developed Ethernet devices. Many industrial devices, such as PLCs, DCSs, HMIs, instruments, and smart meters, use Modbus protocol as the communication standard. It is used to establish master-slave communication between intelligent devices.

However, the Ethernet-based Modbus protocol is so different from the original serial-based protocols. In order to integrate Modbus networks, the IoT Gateway, including one or more serial ports that support RS-232 and RS-485 communication interface, can automatically and intelligently translate between Modbus TCP (Ethernet) and Modbus RTU/ASCII (serial) protocols, allowing Ethernet-based PLCs to control instruments over RS-485 without additional programming or effort.

Serial Port Definition								
Serial Port	Operation Mode	Interface	Baud Rate	Data Bits	Stop Bits	Flow Control	Parity	Action
SPort-0	Modbus	RS-485	9600	8	1	None	None	Edit

NOTE: When Modbus devices are connected to/under the same serial port of IoT Modbus Gateway, those Modbus devices must use the same protocol with the same configuration (i.e., either Modbus RTU or Modbus ASCII with same Baud Rate setting).

Modbus Gateway Scenario

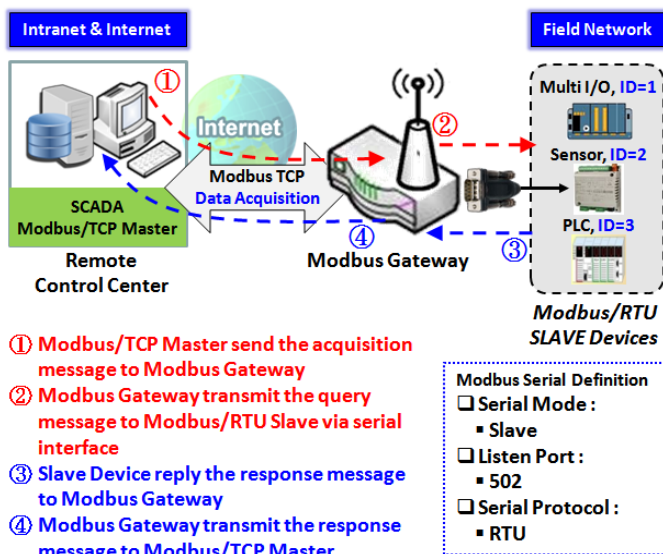

The IoT Gateway serves as a Modbus gateway to communicate with the Modbus TCP Master, the SCADA Server, located at remote control center for Modbus device accessing.

The Modbus TCP Master requests the IoT Gateway for Modbus devices' information, e.g., Data Acquisition or Register/Value Modification, via general Internet accessing, and the IoT Gateway serves as the gateway for data forwarding.

Under such configuration, the Modbus TCP Master requests the information from or sending control commands to various Modbus/RTU Slave devices that attached to the Modbus Gateway. And the Modbus gateway executes corresponding processes and replies the Modbus/TCP Master with the results.

4G IIoT LoRa Gateway

Modbus Slave Scenario

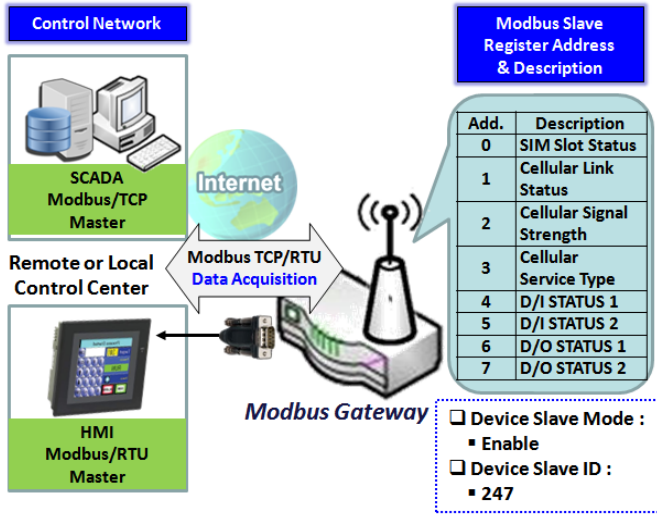

In addition to behave as a Modbus Gateway, there is an integrated Modbus Slave option for providing some device status, like Cellular Network Status, device DI/DO status, to remote Modbus Master via Modbus communication.

With the Slave option enabled, the Modbus Master device can request the information or sending control commands to the IoT Gateway, the Modbus TCP/RTU Slave device. And IoT Gateway executes corresponding processes and replies the Modbus Master devices.

4G IIoT LoRa Gateway

Modbus Setting

Go to **Field Communication > Bus & Protocol > Modbus** tab.

The Modbus setting page enables user to configure the gateway to operate as a Modbus gateway, and allow access among Modbus TCP devices (which are connected to Ethernet network) and Modbus RTU/ASCII devices (which are connected to the Serial Port of the gateway). Once completed the Modbus settings in this section, ensure to select Modbus Operation Mode in Port Configuration screen to enable Modbus communication on the serial port.

Define Modbus Gateway function for each Serial Port

Modbus Gateway Definition						
Serial Port	Gateway Mode	Device Slave Mode	Listen Port	Serial Protocol	Enable	Action
▶ SPort-0	Disable	Slave Mode: Disable	502	RTU	<input checked="" type="checkbox"/>	Edit

Modbus Gateway Definition		
Item	Value setting	Description
Serial Port	N/A	It displays the name of the serial port used. E.g. SPort-0. The number of serial ports varies from the purchased model.
Gateway Mode	Disable is set by default	Specify the Modbus gateway mode for the selected serial port. It can be Disable , Serial as Slave or Serial as Master . A serial port can be attached with one Modbus Master, or daisy-chained a group of Modbus Slave devices. Disable: Select this to disable the respective Modbus gateway function for the selected serial port. Serial as Slave: Select this when the attached serial device(s) are all Modbus Slave devices. Serial as Master: Select this when the attached serial device is a Modbus Master device.
Device Slave Mode	Disable is set by default	Check the Enable box to activate the integrated Modbus Slave function, and enter the preferred ID for the integrated Modbus slave. So that, it can function as a Modbus Slave device, and can be accessed with legacy Modbus Function Code from a SCADA management system. Supported Modbus commands are listed in the following Table. Value Range: 1 ~ 247.
Listen Port	1. 502 is set by default 2. Range 1 to 65535	Specify the Listen Port number if Slave device(s) is attached to the selected serial port. It is a don't care setting if a Master device is attached. Value Range: 1 ~ 65535.

4G IIoT LoRa Gateway

		Note: Use different port number among the serial ports for the product with multiple serial ports.
Serial Protocol	RTU is set by default	Select the serial protocol that is adopted by the attached Modbus device(s). It can be RTU or ASCII .
Enable	N/A	It displays whether the specific Modbus serial port is enabled or disabled. To enable or disable Modbus serial port, go to Field Communication > Bus & Protocol > Port Configuration tab, and set the operation mode as Modbus .

Specify Gateway Configuration

Gateway Mode Configuration for SPort-0	
Item	Setting
▶ Response Timeout	<input type="text" value="1000"/> ms (1~65535)
▶ Timeout Retries	<input type="text" value="0"/> times (0~5)
▶ 0Bh Exception	<input type="checkbox"/> Enable
▶ Tx Delay	<input type="checkbox"/> Enable
▶ TCP Connection Idle Time	<input type="text" value="300"/> sec (1~65535)
▶ Maximum TCP Connections	<input type="text" value="1"/> connections (1~4)
▶ TCP Keep-alive	<input type="checkbox"/> Enable
▶ Modbus Master IP Access	<input type="text" value="Allow All"/> ▼
▶ Message Buffering	<input type="checkbox"/> Enable

Gateway Mode Configuration for SPort-n		
Item	Value setting	Description
Response Timeout	1000 ms is set by default	This sets the response timeout of the slave after master request sent. If the slave does not response within the specified time, data would be discarded. This applies to the serially attached Master sent request over to the remote Slave or requests send from the remote Master sent to the serially attached Slave. <u>Value Range:</u> 1 ~ 65535.
Timeout Retries	0 is set by default	If the slave does not respond to the Master's request, the gateway will resend the request stored in the buffer. If Timeout retries is set to null (value zero), the gateway would not buffer Master requests. If a value other than zero is specified, the gateway would store the Master request in the buffer and retries to send the request in a number of specified times. Once the retries are exhausted, the gateway will send a Modbus error message to the Master. However, if the 0Bh exception box is checked (see below), a 0Bh hex code based-error message will be send instead. <u>Value Range:</u> 0 ~ 5.

4G IIoT LoRa Gateway

0Bh Exception	The box is unchecked by default.	Check the Enable box to enable gateway to send a 0Bh exception code message to Modbus Master to indicate that the slave device does not respond within the timeout interval.
Tx Delay	The box is unchecked by default.	Check the Enable box to activate to the minimum amount of time after receiving a response before the next message can be sent out. When Tx Delay is enabled the Gateway would insert a Tx delay between Master requests. The delay gives sufficient time for the slave devices to turn their transmitters off and their receivers back on.

Setup TCP/IP Connection for Receiving Modbus Master Request

The following Modbus TCP Configuration items allow user to set up the TCP connection settings so that the remote Modbus Master can access to the Modbus gateway. Besides, it also allows user to specify authorized masters on the TCP network.

Item	Value setting	Description
TCP Connection Idle Time	1. 300 is set by default 2. Range 1 to 65535	Enter the idle timeout in seconds. If the gateway does not receive another TCP request before the idle timeout elapsed, the TCP session will be terminated automatically. Value Range: 1 ~ 65535.
Maximum TCP Connections	1. 4 is set by default 2. Range 1 to 4	Enter the allowed maximum simultaneous TCP connections. Value Range: 1 ~ 4.
TCP Keep-alive	The box is unchecked by default.	Check the Enable box to ensure to keep the TCP session connected.
Modbus Master IP Access	Allow All is selected by default.	Specify authorized masters on the TCP network. Select Allow All to allow any Modbus Master to reach the attached Slave(s). Otherwise, limit only specific Master to reach the Slave(s) by selecting Specific IPs . When Specific IPs is selected, a Trusted IP Definition dialog will appear.

Specify Trusted Modbus Masters on the TCP network

When **Specific IPs** is selected, user has to specify the Master(s) by their IP addresses to reach the serially attached Slave(s).

▶ Modbus Master IP Access	Specific IPs ▼			
▶ Trusted IP Definition	ID	Source IP	Enable	Action
	1	Specific IP Address ▼ <input type="text"/>	<input type="checkbox"/>	Edit
	2	<input type="text"/>	<input type="checkbox"/>	Edit
	3	<input type="text"/>	<input type="checkbox"/>	Edit
	4	<input type="text"/>	<input type="checkbox"/>	Edit

Item	Value setting	Description
------	---------------	-------------

4G IIoT LoRa Gateway

Source IP	A Must fill setting	<p>Select Specific IP Address to only allow an IP address of the allowed Master to access the attached Slave(s).</p> <p>Select IP Range to only allow a set range of IP addresses of the allowed Master to access the attached Slave(s).</p> <p>Select IP Address-based Group to only allow pre-defined group of IP address of the allowed Master to access the attached Slave(s).</p> <p>Note: group must be pre-defined before this selection become available. Refer to Object Definition > Grouping > Host grouping. You may also access to create a group by the Add Rule shortcut button. Setting done through the Add Rule button will also appear in the Host grouping setting screen.</p> <p>Then check Enable box to enable this rule.</p>
Enable	Unchecked by default	Check the Enable box to enable this rule.

Modbus Priority Definition

Message Buffering must be enabled to prioritize Master request queue to transmit to Modbus Slave as mentioned in the above. Click the **Edit** button to fill in the priority settings.

▶ Message Buffering	<input checked="" type="checkbox"/> Enable																				
▶ Modbus Priority Definition	<table border="1"> <thead> <tr> <th>Modbus Priority</th> <th>Priority Base</th> <th>Enable</th> <th>Action</th> </tr> </thead> <tbody> <tr> <td>▶ Modbus Priority 1</td> <td>IP Address ▼ <input type="text"/></td> <td><input type="checkbox"/></td> <td>Edit</td> </tr> <tr> <td>▶ Modbus Priority 2</td> <td></td> <td><input type="checkbox"/></td> <td>Edit</td> </tr> <tr> <td>▶ Modbus Priority 3</td> <td></td> <td><input type="checkbox"/></td> <td>Edit</td> </tr> <tr> <td>▶ Modbus Priority 4</td> <td></td> <td><input type="checkbox"/></td> <td>Edit</td> </tr> </tbody> </table>	Modbus Priority	Priority Base	Enable	Action	▶ Modbus Priority 1	IP Address ▼ <input type="text"/>	<input type="checkbox"/>	Edit	▶ Modbus Priority 2		<input type="checkbox"/>	Edit	▶ Modbus Priority 3		<input type="checkbox"/>	Edit	▶ Modbus Priority 4		<input type="checkbox"/>	Edit
Modbus Priority	Priority Base	Enable	Action																		
▶ Modbus Priority 1	IP Address ▼ <input type="text"/>	<input type="checkbox"/>	Edit																		
▶ Modbus Priority 2		<input type="checkbox"/>	Edit																		
▶ Modbus Priority 3		<input type="checkbox"/>	Edit																		
▶ Modbus Priority 4		<input type="checkbox"/>	Edit																		

Item	Value setting	Description
Message Buffering	<ol style="list-style-type: none"> 1. Unchecked by default 2. Buffer up to 32 requests 	<p>Check the Enable box to buffer up to 32 requests from Modbus Master.</p> <p>If the Enable box is checked, a Modbus Priority Definition dialog will appear consequently. So that, the buffered Master requests can further be configured to prioritize request queue to transmit to Slave based on Master's IP address if requests are coming from remote Master, or based on remote Slave ID if requests are coming from serially attached Master, or based on Function Code.</p>
Modbus Priority	N/A	<p>A Priority List for setting the priority of specified Modbus identity.</p> <p>Modbus Priority 1 ~ Modbus Priority 4.</p>
Priority Base	IP Address by Default	<p>User can specify a Modbus identity with IP Address, Slave ID, or Function Code.</p> <p>The buffered Modbus message that matched the specified identity will be handled with given priority.</p> <p>The Modbus Master requests can be buffered to a certain priority queue according to the Master's IP address if requests are coming from remote Master, or the remote Slave's device ID if requests are coming from serially attached Master, or the specific Function Code that issued by Master.</p>

4G IIoT LoRa Gateway

Enable	Unchecked by default	Check the Enable box to enable the priority settings.
Save	N/A	Click the Save button to save the settings.

Specify Modbus TCP Slave device(s)

If there is a Modbus Master device is attached to a certain serial port of the Modbus Gateway, user has to further specify the Modbus TCP Slave device(s) to send requests to from the attached Modbus RTU/ASCII Master device.

ID	IP	Port	ID Range	Enable	Actions
----	----	------	----------	--------	---------

When the **Add** button is applied, a **Modbus TCP Slave Configuration** screen will appear.

Item	Setting
▶ IP	<input type="text"/>
▶ Port	<input type="text"/> (1~65535)
▶ ID Range	<input type="text"/> (1~247) ~ <input type="text"/> (1~247)
▶ Enable	<input type="checkbox"/>

Modbus Remote Slave Configuration		
Item	Value setting	Description
IP	A Must fill setting	Enter the IP address of the remote Modbus TCP Slave device.
Port	1. A Must fill setting 2. Range 1 to 65535	Enter the TCP port on which the remote Modbus TCP Slave device listens (to the TCP client session request). Value Range: 1 ~ 65535.
ID Range	Range 1 to 247	Enter the Modbus ID range for the Modbus TCP Slave(s) that will respond to the Master's request. In addition to specify the Slave IP and Port, for accessing those Remote Modbus RTU Slave(s) located behind another Modbus Gateway, user has to specify the Modbus ID range of the Modbus RTU Slave(s). Value Range: 1 ~ 247.
Enable	It is unchecked by default.	Check the Enable box to enable this rule.
Save	N/A	Click the Save button to save the settings.

4G IIoT LoRa Gateway

Supported Function Code for Integrated Modbus Slave

This setting can setup the Gateway as a standalone Modbus Slave Device. Local SCADA Management System can treat the Gateway as a Slave device, and hence is able to read its information for device monitoring.

Currently, the integrated Modbus Slave device supports the following commands for accessing the 3G/4G Modem Status of the Gateway.

Function Code: 0x03(/Read). 0x06(/Write)

Address: 0 ~ 9999

Register Address	Register Name	R / W	Register Range / Description
0	WAN-1 Connection Status	R	0 ~ 6, 0=Disconnected, 1=Connecting..., 2=Connected, 3=Disconnecting..., 5=Wait for Traffic..., 6=Diconnected
1	WAN-2 Connection Status	R	0 ~ 6, 0=Disconnected, 1=Connecting..., 2=Connected, 3=Disconnecting..., 5=Wait for Traffic..., 6=Diconnected
2	WAN-3 Connection Status	R	0 ~ 6, 0=Disconnected, 1=Connecting..., 2=Connected, 3=Disconnecting..., 5=Wait for Traffic..., 6=Diconnected
3	WAN-4 Connection Status	R	0 ~ 6, 0=Disconnected, 1=Connecting..., 2=Connected, 3=Disconnecting..., 5=Wait for Traffic..., 6=Diconnected
10	3G/4G_SERVICE_TYPE	R	0 ~ 7, 0=2G, 1=none, 2=3G, 3=3.5G, 4~6=3.75G, 7=LTE
11	3G/4G_LINK_STATUS	R	0 ~ 6, 0=Disconnected, 1=Connecting..., 2=Connected, 3=Disconnecting..., 5=Wait for Traffic..., 6=Diconnected
12	3G/4G_SIGNAL_STRENGTH	R	0 ~ 100
13	3G/4G_SIM_STATUS	R	0 : SIM card with PIN code insert 1 : SIM card ready 2 : No SIM card
14	3G/4G_MCC	R	MCC Value
15	3G/4G_MNC	R	MNC Value
16	3G/4G_CS Register Status	R	0 : Unregistered, 1: Registered
17	3G/4G_PS Register Status	R	0 : Unregistered, 1: Registered
18	3G/4G_Roaming Status	R	0 : Not Roaming, 1: Roaming
19	3G/4G_RSSI	R	RSSI Value
20	3G/4G_RSRP	R	RSRP Value
21	3G/4G_RSRQ	R	RSRQ Value
30	3G/4G_Module-2_SERVICE_TYPE	R	0 ~ 7, 0=2G, 1=none, 2=3G, 3=3.5G, 4~6=3.75G, 7=LTE
31	3G/4G_Module-2_LINK_STATUS	R	0 ~ 6, 0=Disconnected, 1=Connecting..., 2=Connected, 3=Disconnecting..., 5=Wait for Traffic..., 6=Diconnected
32	3G/4G_Module-2_SIGNAL_STRENGTH	R	0 ~ 100

4G IIoT LoRa Gateway

Register Address	Register Name	R / W	Register Range / Description
33	3G/4G_Module-2_SIM_STATUS	R	0 : SIM card with PIN code insert 1 : SIM card ready 2 : No SIM card
34	3G/4G_Module-2_MCC	R	MCC Value
35	3G/4G_Module-2_MNC	R	MNC Value
36	3G/4G_Module-2_CS Register Status	R	0 : Unregistered, 1: Registered
37	3G/4G_Module-2_PS Register Status	R	0 : Unregistered, 1: Registered
38	3G/4G_Module-2_Roaming Status	R	0 : Not Roaming, 1: Roaming
39	3G/4G_Module-2_RSSI	R	RSSI Value
40	3G/4G_Module-2_RSRP	R	RSRP Value
41	3G/4G_Module-2_RSRQ	R	RSRQ Value
70	ADSL_Download_Data rate	R	ADSL Download Data rate value (kbps)
71	ADSL_Upload_Data rate	R	ADSL Upload Data rate value (kbps)
72	ADSL SNR_Download	R	ADSL SNR Download value (dB)
73	ADSL SNR_Upload	R	ADSL SNR Upload value (dB)
74	ADSL modem link status	R	0 : Disconnected, 1: Connected
101	VPN IPSec tunnel 1 status	R	1 : Connected, 2 : Wait for traffic , 3 : Disconnected , 9 : Connecting
102	VPN IPSec tunnel 2 status	R	1 : Connected, 2 : Wait for traffic , 3 : Disconnected , 9 : Connecting
103	VPN IPSec tunnel 3 status	R	1 : Connected, 2 : Wait for traffic , 3 : Disconnected , 9 : Connecting
104	VPN IPSec tunnel 4 status	R	1 : Connected, 2 : Wait for traffic , 3 : Disconnected , 9 : Connecting
105	VPN IPSec tunnel 5 status	R	1 : Connected, 2 : Wait for traffic , 3 : Disconnected , 9 : Connecting
106	VPN IPSec tunnel 6 status	R	1 : Connected, 2 : Wait for traffic , 3 : Disconnected , 9 : Connecting
107	VPN IPSec tunnel 7 status	R	1 : Connected, 2 : Wait for traffic , 3 : Disconnected , 9 : Connecting
108	VPN IPSec tunnel 8 status	R	1 : Connected, 2 : Wait for traffic , 3 : Disconnected , 9 : Connecting
109	VPN IPSec tunnel 9 status	R	1 : Connected, 2 : Wait for traffic , 3 : Disconnected , 9 : Connecting
110	VPN IPSec tunnel 10 status	R	1 : Connected, 2 : Wait for traffic , 3 : Disconnected , 9 : Connecting
111	VPN IPSec tunnel 11 status	R	1 : Connected, 2 : Wait for traffic , 3 : Disconnected , 9 : Connecting
112	VPN IPSec tunnel 12 status	R	1 : Connected, 2 : Wait for traffic , 3 : Disconnected , 9 : Connecting
113	VPN IPSec tunnel 13 status	R	1 : Connected, 2 : Wait for traffic , 3 : Disconnected , 9 : Connecting
114	VPN IPSec tunnel 14 status	R	1 : Connected, 2 : Wait for traffic , 3 : Disconnected , 9 : Connecting
115	VPN IPSec tunnel 15 status	R	1 : Connected, 2 : Wait for traffic , 3 : Disconnected , 9 : Connecting
116	VPN IPSec tunnel 16 status	R	1 : Connected, 2 : Wait for traffic , 3 : Disconnected , 9 : Connecting

4G IIoT LoRa Gateway

Register Address	Register Name	R / W	Register Range / Description
150	DI_STATUS_1	R	0 : OFF, 1 : ON
151	DO_STATUS_1	R/W	0 : OFF, 1 : ON
152	DI_STATUS_2	R	0 : OFF, 1 : ON
153	DO_STATUS_2	R/W	0 : OFF, 1 : ON
154	DI_STATUS_3	R	0 : OFF, 1 : ON
155	DO_STATUS_3	R/W	0 : OFF, 1 : ON
156	DI_STATUS_4	R	0 : OFF, 1 : ON
157	DO_STATUS_4	R/W	0 : OFF, 1 : ON
201	Serial Port-0_Interface	R	1 : RS-232, 3 : RS-485
202	Serial Port-0_Baud Rate	R	Baud Rate Value
203	Serial Port-0_Data Bits	R	7 or 8
204	Serial Port-0_Stop Bits	R	1 or 2
205	Serial Port-0_Flow Control	R	0 : None, 2 : RTS,CTS, 3 : DTR,DSR
206	Serial Port-0_Parity	R	0 : None, 1 : Odd, 2 : Even
211	Serial Port-1_Interface	R	1 : RS-232, 3 : RS-485
212	Serial Port-1_Baud Rate	R	Baud Rate Value
213	Serial Port-1_Data Bits	R	7 or 8
214	Serial Port-1_Stop Bits	R	1 or 2
215	Serial Port-1_Flow Control	R	0 : None, 2 : RTS,CTS, 3 : DTR,DSR
216	Serial Port-1_Parity	R	0 : None, 1 : Odd, 2 : Even
221	Serial Port-2_Interface	R	1 : RS-232, 3 : RS-485
222	Serial Port-2_Baud Rate	R	Baud Rate Value
223	Serial Port-2_Data Bits	R	7 or 8
224	Serial Port-2_Stop Bits	R	1 or 2
225	Serial Port-2_Flow Control	R	0 : None, 2 : RTS,CTS, 3 : DTR,DSR
226	Serial Port-2_Parity	R	0 : None, 1 : Odd, 2 : Even
231	Serial Port-3_Interface	R	1 : RS-232, 3 : RS-485
232	Serial Port-3_Baud Rate	R	Baud Rate Value
233	Serial Port-3_Data Bits	R	7 or 8
234	Serial Port-3_Stop Bits	R	1 or 2
235	Serial Port-3_Flow Control	R	0 : None, 2 : RTS,CTS, 3 : DTR,DSR
236	Serial Port-3_Parity	R	0 : None, 1 : Odd, 2 : Even
9999	System_Reboot	W	Set 1 for System reboot.

4G IIoT LoRa Gateway

4.2 Data Logging

Data logging is the process of collecting and storing data over a period of time in order to analyze specific trends or record the data-based events/actions of a system, or connected devices. Data logging function is a very useful and also important feature for SCADA telemetry; it makes the monitoring and analyzing tasks easier by checking the status and historical data during whole data acquisition period.

Even facing the network connection problems with remote NOC/SCADA side, you can also enable the data logging proxy function provided by the purchased gateway and keep doing the data acquisition and storing the collected data in local storage (in .CSV file format). When the network connection recovered, admin/user can download the data log files manually via FTP or web UI for further reference and maintenance.

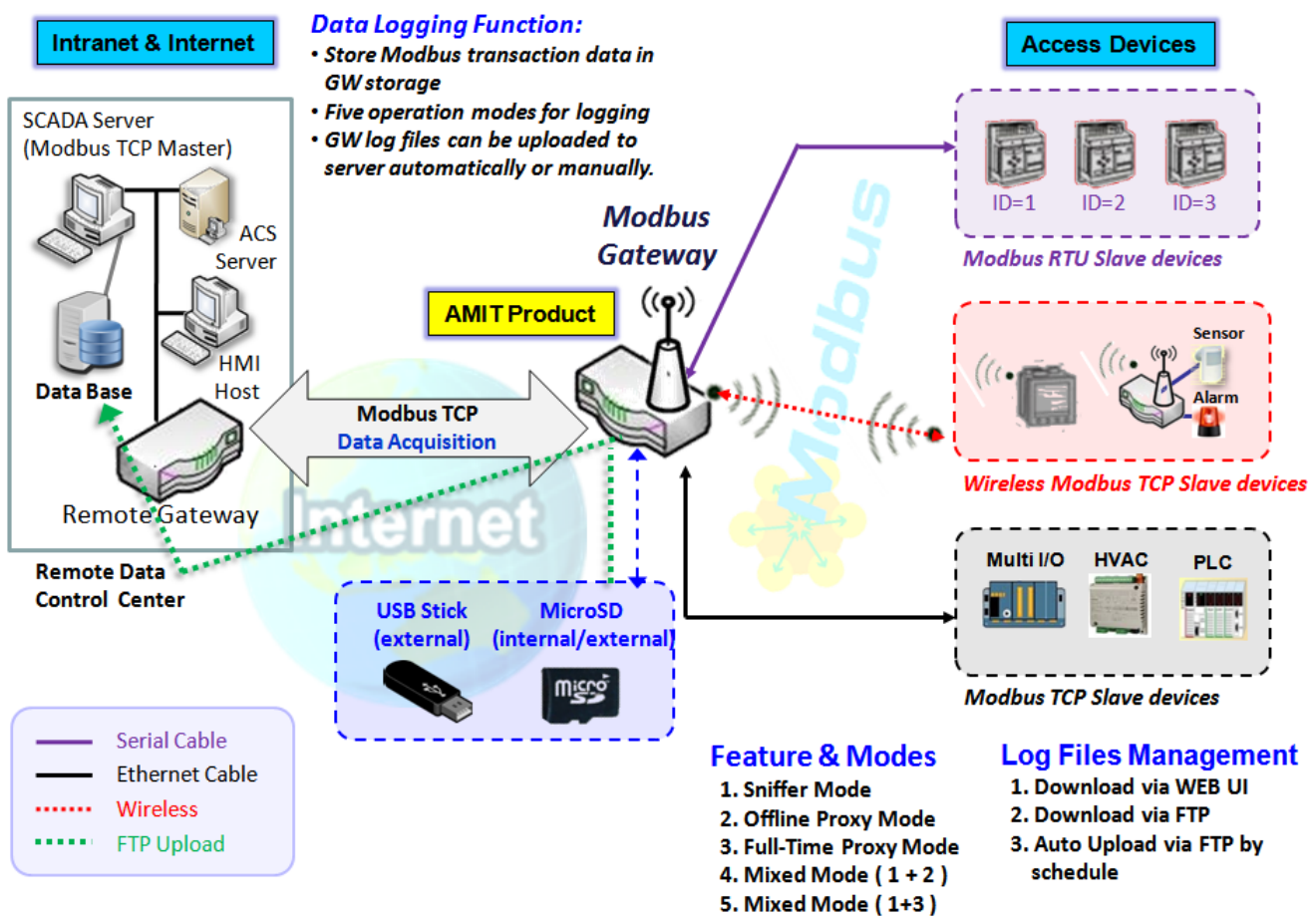

The Modbus Cellular Gateway provides a complete data logging function for collecting the Modbus transaction data for application requirements. There are some data logging schemes to meet different management requirements. They are the Sniffer Mode, Offline Proxy Mode, Full-Time Proxy Mode, and the mixed modes for sniffer and proxy combinations.

With the Sniffer mode enabled, the gateway will monitor and record the communication among a specific Modbus Master and related slaves. It will store the Modbus communication as log files and administrator can check what Modbus communication went over the Modbus gateway, and if there is any communication loss

4G IIoT LoRa Gateway

among the Master and Slave sides or not.

However, if there is any network connection problem between the Modbus gateway and remote NOC/SCADA, the remote Modbus server can't reach the Slave devices attached to the Modbus gateway, and consequently, nothing can be monitored and stored under such situation.

With the Proxy mode option enabled, when the Modbus gateway lost the connection with specified Modbus server, it will take over the data acquisition task and keep collecting the required data from Slave devices automatically. Once the connection is recovered, the Modbus gateway may stop the data log proxy function. Remote Modbus server can keep its data acquisition process, and if required, the administrator can also get the stored data log files to tell if everything goes well or not.

Under the Data Logging Proxy mode, user has to create some data acquisition rules via "Proxy Mode Rule Configuration" for collecting the Slave devices data by the Gateway when required. Once the network connection to remote SCADA was lost unexpectedly, the Data Logging Proxy function will be triggered and begin to do the data polling tasks by those pre-defined rules running in background.

➤ Scenario for Sniffer Mode Data Logging

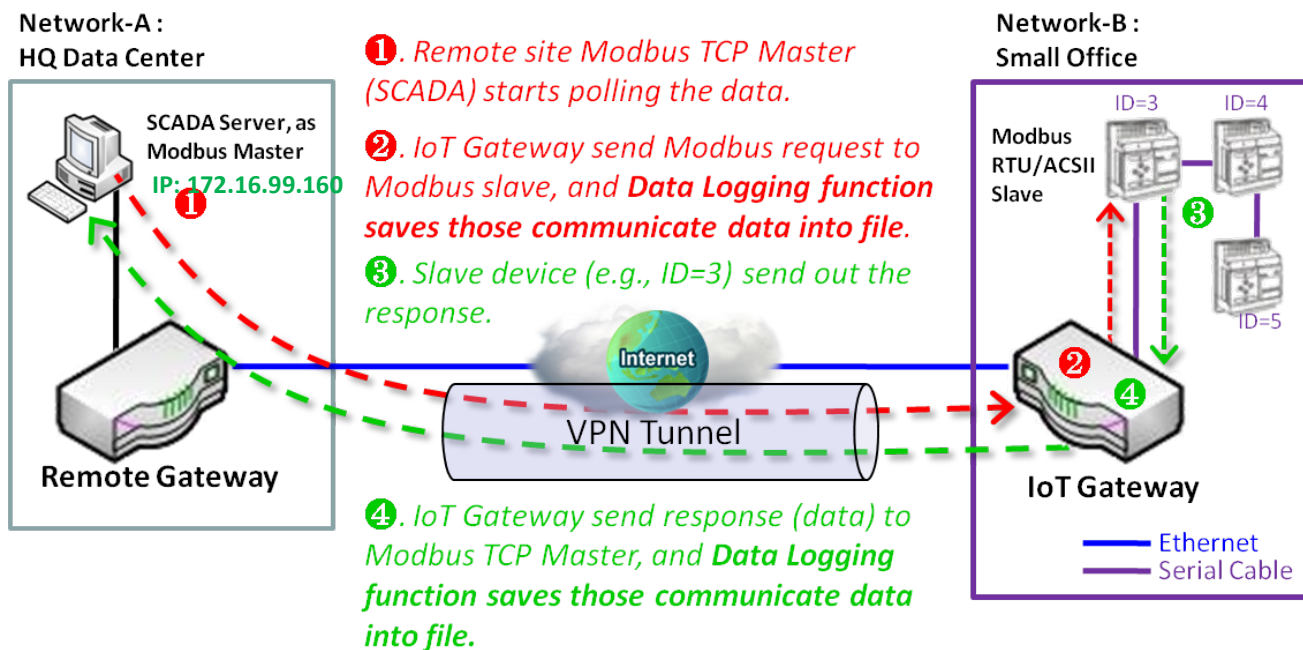

As Illustrated in the diagram, the Modbus gateway will store the following Modbus activities into a log file.

- The Modbus request sent from Remote Modbus TCP Master.
- The response (data) that sent out from the polled Slave device (ID=3)

➤ Scenario for Off-Line Proxy Mode Data Logging

4G IIoT LoRa Gateway

Network-A:
HQ Data Center

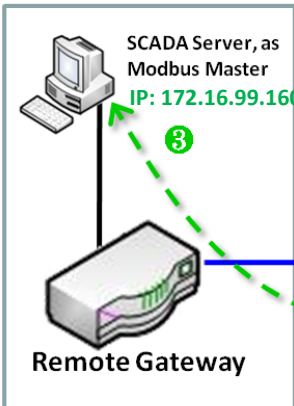

- 1 To do the Data-Acquisition by IoT Gateway itself automatically.
- 2 Save those data as files to internal or external storage unit (e.g., Micro-SD card).
- 3 Data Logging Files Downloading via FTP or WEB UI.

Network-B:
Small Office

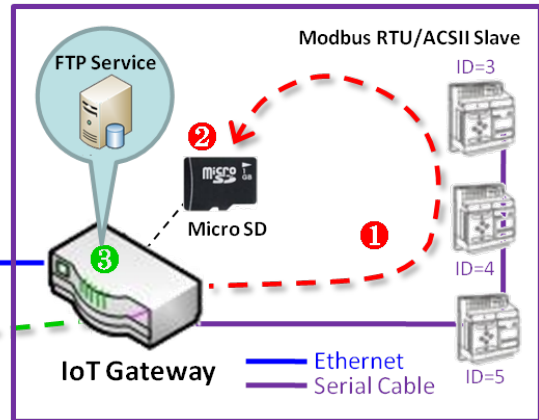

As illustrated, when the connection to a remote Modbus Master broken, the Modbus Gateway will activate the data logging proxy function and execute the pre-defined data acquisition task by itself.

- The Modbus request issued by the Modbus Gateway (Data Logging Proxy).
- The response (data) that sent out from the polled Slave device (ID=3)

Repeat above data acquisition and data logging activities on every 5 sec interval until the connection recovered.

4G IIoT LoRa Gateway

4.2.1 Data Logging Configuration

Data Logging is commonly used in monitoring systems to collect and analyze the field data. With proper configuration, the Gateway will record Modbus messages according to the specified rule list.

Go to **Field Communication > Data Logging > Configuration** tab.

Enable Data Logging

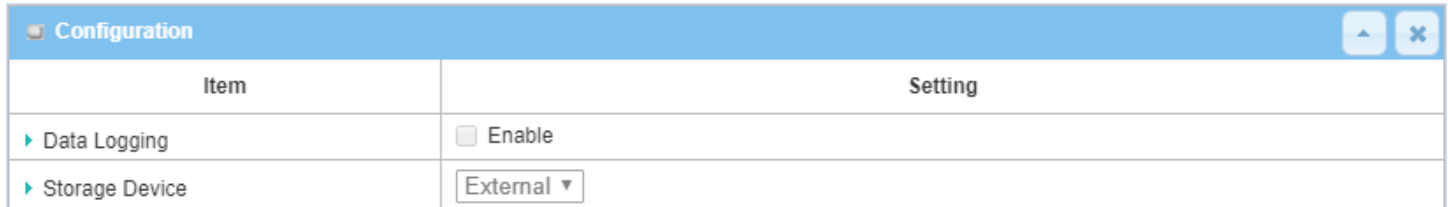

Item	Setting
▶ Data Logging	<input type="checkbox"/> Enable
▶ Storage Device	External ▾

Configuration Item	Value setting	Description
Data Logging	The box is unchecked by default.	Check the Enable box to activate to data logging function.
Storage Device	External is set by default	Choose the sotrage device to store the log files. It can be External or Internal , depends on the product specification.
Save	NA	Click the Save button to save the settings.

Note:

1. If there is no available storage device, the Enable checkbox will be grayed, and you can't enable it for the data logging. That is, if you selected External Storage, plug-in the storage first, and then enable the function and also make the required configuration.
2. Make sure the Modbus Operation Mode is selected and enabled, or there will be no Modbus transactions to be logged. Please refer to **Field Communication > Bus & Protocol > Port Configuration** and **Modbus** tabs.

Create/Edit Modbus Proxy Rules

The Gateway allows you to customize your proxy mode rule list. It supports up to a maximum of 20 rules.

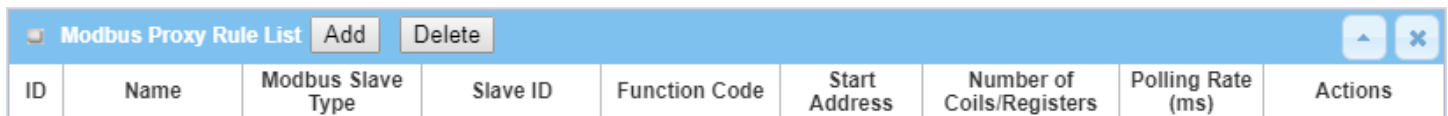

ID	Name	Modbus Slave Type	Slave ID	Function Code	Start Address	Number of Coils/Registers	Polling Rate (ms)	Actions
----	------	-------------------	----------	---------------	---------------	---------------------------	-------------------	---------

When the **Add** button is applied, **Modbus Proxy Rule Configuration** screen will appear.

4G IIoT LoRa Gateway

Modbus Proxy Rule List Configuration
Save Undo
×

Item	Setting
▶ Name	<input style="width: 80%;" type="text"/>
▶ Modbus Slave Type	IP Address:Port ▼ <input style="width: 150px;" type="text"/> : <input style="width: 50px;" type="text"/>
▶ Slave ID	<input style="width: 50px;" type="text"/> (1~247) - <input style="width: 50px;" type="text"/> (1~247)
▶ Function Code	Read Coils (0x01) ▼
▶ Start Address	<input style="width: 50px;" type="text"/> (0~65535)
▶ Number of Coils/Registers	<input style="width: 50px;" type="text"/> (1~125)
▶ Polling Rate (ms)	<input style="width: 50px;" type="text" value="1000"/> (500~99999)

Modbus Proxy Rule Configuration		
Item	Value setting	Description
Name	A Must filled setting.	Specify a name as the identifier of the Modbus proxy rule. Value Range: 1 ~ 32 characters.
Modbus Slave Type	IP Address :Port is selected by default.	Specify the Modbus Slave devices to apply with the Modbus proxy rule. It can be IP Address:Port for Modbus TCP slaves or Local Serial Port for local attached Modbus RTU/ASCII slaves. Value Range: 1 ~ 65535 for port number
Slave ID	1. A Must filled setting. 2. Range 1 to 247	Specify the ID range for the slave device(s) to apply with the Modbus proxy rule. Value Range: 1 ~ 247.
Function Code	Read Coils (0x01) is selected by default.	Specify a certain read function for the Data Logging Proxy to issue and record the responses from device(s).
Start Address	1. A Must filled setting. 2. Range 0 to 65535	Specify the Start Address of registers to apply with the specified function code. Value Range: 0 ~ 65535.
Number of Coils/Registers	1. A Must filled setting. 2. Range 1 to 125	Specify the number of coils/registers to apply with the specified function code. Value Range: 1 ~ 125. Note: Start Address plus Number must be smaller than 65536.
Polling Rate (ms)	1. A Must filled setting. 2. 1000 ms is set by default	Enter the poll time in milliseconds to apply the Proxy Mode Rule. Once the proxy mode is activated, the Modbus Gateway will issue pre-defined Modbus message on each Poll Time interval accordingly. Value Range: 500 ~ 99999.
Save	N/A	Click the Save button to save the settings.
Undo	N/A	Click the Undo button to cancel the changes.

4G IIoT LoRa Gateway

4.2.2 Scheme Setup

There are five data logging schemes to meet different management requirements. They are the Sniffer Mode, Offline Proxy Mode, Full-Time Proxy Mode, and the mixed modes for sniffer and proxy combinations. User has to configure the required data logging rules with selected scheme in this Scheme Setup page.

Go to **Field Communication > Data Logging > Scheme Setup** tab.

Create/Edit Data Logging Rules

Scheme List <input type="button" value="Add"/> <input type="button" value="Delete"/>							
ID	Name	Mode	Master Type	Master Query Timeout (sec)	Proxy Rules	Enable	Actions

When the **Add** button is applied, **Scheme Configuration** screen will appear.

Scheme Configuration <input type="button" value="Save"/> <input type="button" value="Undo"/>	
Item	Setting
▶ Name	<input type="text"/>
▶ Mode	Sniffer ▼
▶ Master Type	IP Address ▼ <input type="text"/>
▶ Enable	<input type="checkbox"/>

Scheme Configuration		
Item	Value setting	Description
Name	A Must filled setting.	Specify a name as the identifier of the data logging rule. Value Range: 1 ~ 16 characters.
Mode	Sniffer is selected by default.	Select an expected data logging scheme for the data logging rule. There are five available schemes : Sniffer : The Modbus gateway will record all the Modbus transacations between the Master and Slave devices. Off-Line Proxy : When the connection between the Modbus gateway and Master is lost, the pre-defined proxy rule will be triggered and the Modbus gateway will issue specified function code to collect and record the data / status from the slave devices Full-Time Proxy : The pre-defined proxy rule will be triggered all the time and the Modbus gateway will issue specified function code to collect and record the data / status from the slave devices Sniffer & Off-Line Proxy : This is a mixed mode for both Sniffer and Off-Line Proxy modes. Sniffer & Full-Time Proxy : This is a mixed mode for both Sniffer and Full-Time Proxy modes.

4G IIoT LoRa Gateway

Master Type	IP Address is selected by default.	Specify the Modbus master device to apply with the data logging rule. It can be IP Address for Modbus TCP master, or Local Serial Port for local attached Modbus RTU/ASCII master.
Master Query Timeout (sec.)	1. An Optional setting. 2. 60 sec is set by default 3. Range 1 to 99999	Specify the timeout value for querying Modbus Master. If no response from the master for the specified timeout setting, selected proxy rule will be triggered and applied with the data logging rule. Note: If Off-Line proxy scheme is selected, the timeout setting will be used to check. Otherwise, it is a don't care value.
Proxy Rules	An Optional setting.	Select the Proxy rule to be applied with the data logging rule. Note: If any proxy scheme is selected, please create the required Proxy rules in advance, and select from the list.
Enable	The box is unchecked by default.	Check the box to activate the data logging rule.
Save	N/A	Click the Save button to save the settings.
Undo	N/A	Click the Undo button to cancel the changes.

4G IIoT LoRa Gateway

4.2.3 Log File Management

There are five data logging schemes to meet different management requirements. They are the Sniffer Mode, Off-Line Proxy Mode, Full-Time Proxy Mode, and the mixed modes for sniffer and proxy combinations. User has to configure the required data logging rules with selected scheme in this Scheme Setup page.

Go to **Field Communication > Data Logging > Log File Management** tab.

If user had created data log rules in the **Field Communication > Data Logging > Scheme Setup** tab, there will be a log file list shown in the following Log File list screen. The default Log File management settings will be applied if user didn't change it via the **Edit** button.

Log File List								
ID	Name	File Content Format	Split File by	Auto Upload	Log File Compression	Delete File After Upload	When Storage Full	Actions
1	Sniffer Log	Raw Data	200 KB	Disabled	N/A	N/A	Remove the Oldest	<input type="button" value="Edit"/> <input type="button" value="Download Log"/>

When the **Edit** button is applied, **Log File Configuration** screen will appear.

Log File List Configuration	
Item	Setting
File Content Format	Raw Data
Split File by	Size 200 KB
Auto Upload	<input checked="" type="checkbox"/> Enable --- Option --- Add Object
Log File Compression	<input type="checkbox"/> Enable
Delete File After Upload	<input type="checkbox"/> Enable
When Storage Full	Remove the Oldest

Log File Configuration		
Item	Value setting	Description
Name	N/A	The name of corresponding data log rule will be displayed. The default log file name will be named as ' Name_ yyyyMMddHHmmSS.csv '.
File Content Format	Raw Data is selected by default	Select the data format for the log files. It can be Raw Data , or Modbus Type .
Split File by	Size and 200 KB are set by default	Specify the split file methodology. It can be by Size , or by Time Interval . User has to specify a certain file size or time interval for splitting the data logs into a series of files. Value Range: 1 ~ 99999.
Auto Upload	1. An Optional filled setting 2. The box is unchecked	Check the Enable box to activate the auto upload function for logged files. Once been enabled, user has to specify an external FTP server from the dropdown list for auto uploading the log files to the server. Refer to Object

4G IIoT LoRa Gateway

	by default.	Definition > External Server > External Server tab, or create the FTP server with the Add Object button.
Log File Compression	1. An Optional filled setting 2. The box is unchecked by default	If Auto Upload is activated, user can further specify whether to compress the log file prior it is uploaded or not. Check the Enable button to activate the Log File Compression function...
Delete File After Upload	1. An Optional filled setting 2. The box is unchecked by default	If Auto Upload is activated, user can further specify whether to delete the transferred log from the gateway storage or not. Check the Enable button to activate the function.
When Storage Full	Remove the Oldest is selected by default	Specify the operation to take when the storage is full. It can be Remove the Oldest log file, or Stop Recording . When Remove the Oldest is selected, the gateway will delete the oldest file once the storage is full, and keep on the data logging activity; When Stop Recording is selected, the gateway will stop the data logging activity once the storage is full.
Save	NA	Click the Save button to save the settings.
Undo	NA	Click the Undo button to cancel the changes.

When the **Download Log** button is applied, the web browser will download a file named as 'log.tar' to the managing host computer.

4.3 Data Interchange

4.3.1 MQTT

MQTT (Message Queuing Telemetry Transport) is an ISO standard (ISO/IEC PRF 20922) publish-subscribe based messaging protocol. It works on top of the TCP/IP protocol. MQTT is a simple messaging protocol, designed for constrained devices with low-bandwidth. So, it's the perfect solution for IoT applications. An MQTT system consists of clients communicating with a server, often called a "broker". A client may be either a publisher of information or a subscriber. Each client can connect to the broker.¹⁰

MQTT allows you to send commands to control outputs, read and publish data from sensor nodes, etc... Information is organized in a hierarchy of topics. When a publisher has a new item of data to distribute, it sends a control message with the data to the connected broker. The broker then distributes the information to any clients that have subscribed to that topic. The publisher does not need to have any data on the number or locations of subscribers, and subscribers in turn do not have to be configured with any data about the publishers. Therefore, it makes it really easy to establish a communication among multiple devices.¹¹

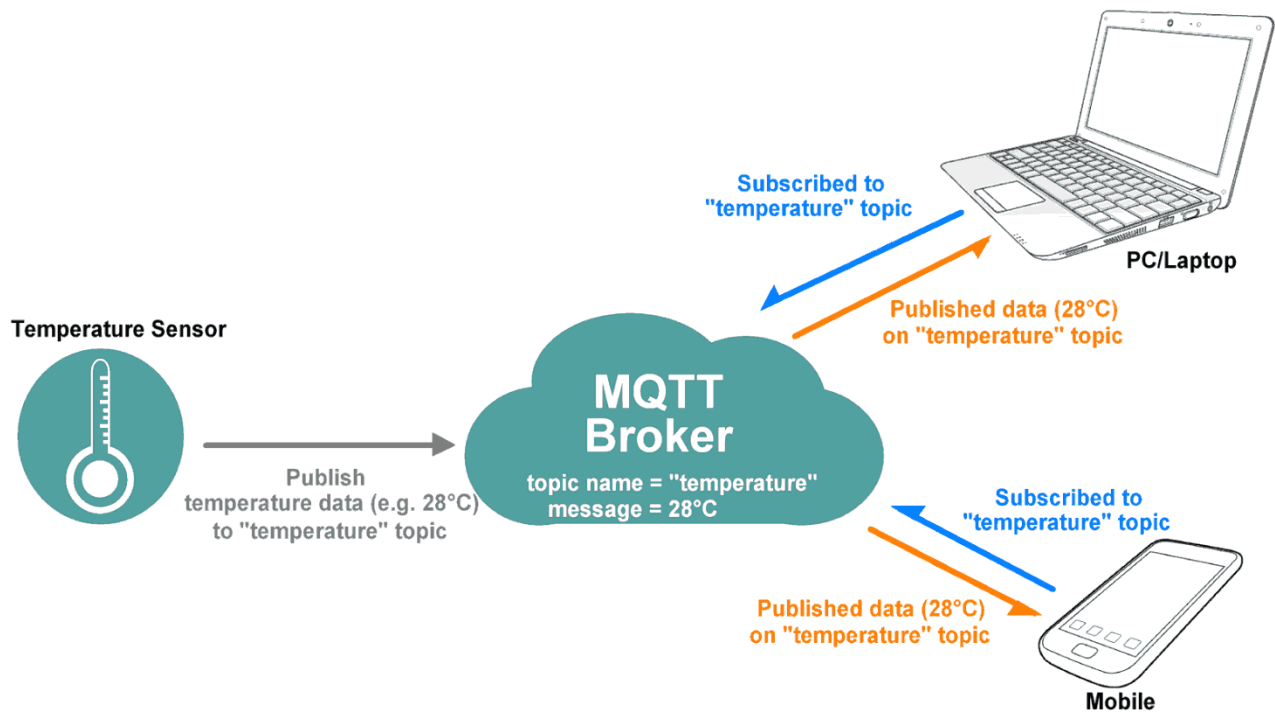

If a broker receives a topic for which there are no current subscribers, it will discard the topic unless the publisher indicates that the topic is to be retained. This allows new subscribers to a topic to receive the most current value rather than waiting for the next update from a publisher.

10 <https://en.wikipedia.org/wiki/MQTT>

11 <https://randomnerdtutorials.com/what-is-mqtt-and-how-it-works/>

4G IIoT LoRa Gateway

When a publishing client first connects to the broker, it can set up a default message to be sent to subscribers if the broker detects that the publishing client has unexpectedly disconnected from the broker.

Clients only interact with a broker, but a system may contain several broker servers that exchange data based on their current subscribers' topics.

In MQTT there are a few basic concepts that you need to understand:

MQTT - Publish and Subscribe

The first concept is the Publish and subscribe system. In a MQTT publish and subscribe based system, a client device can publish a message on a topic, or it can be subscribed to a particular topic to receive messages.

MQTT - Broker

The broker is primarily responsible for receiving all messages, filtering the messages, decide who is interested in them, and then publishing the message to all subscribed clients.

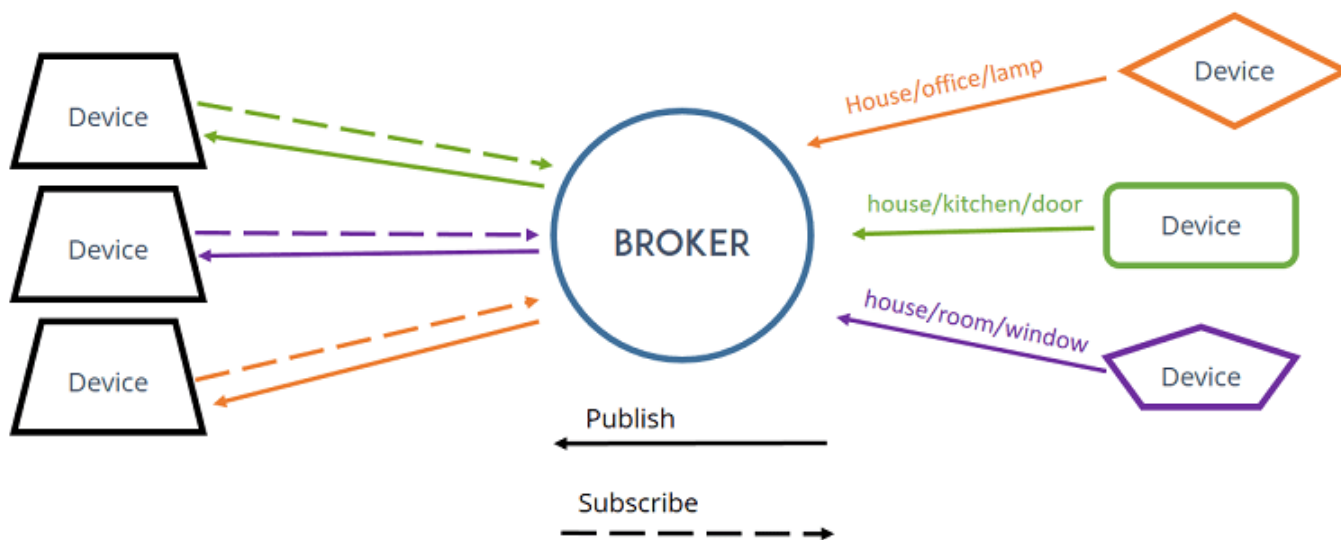

MQTT - Messages

Messages are the information that you want to exchange among your devices. Whether it is a command or data.

A minimal MQTT control message can be as little as two bytes of data. There are fourteen defined message types used to connect and disconnect a client from a broker, to publish data, to acknowledge receipt of data, and to supervise the connection between client and server.

MQTT – Topics

Topics are the way you register interest for incoming messages or how you specify where you want to publish the message.

4G IIoT LoRa Gateway

Topics are represented with strings separated by a forward slash '/'. Each forward slash indicates a topic level. Here's an example on how you would create a topic for a lamp in your home office:

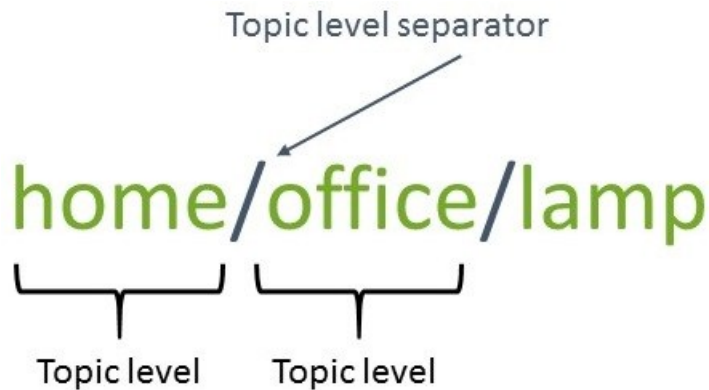

Note: topics are case-sensitive!

If you would like to turn on a lamp in your home office using MQTT, you can imagine the following scenario:

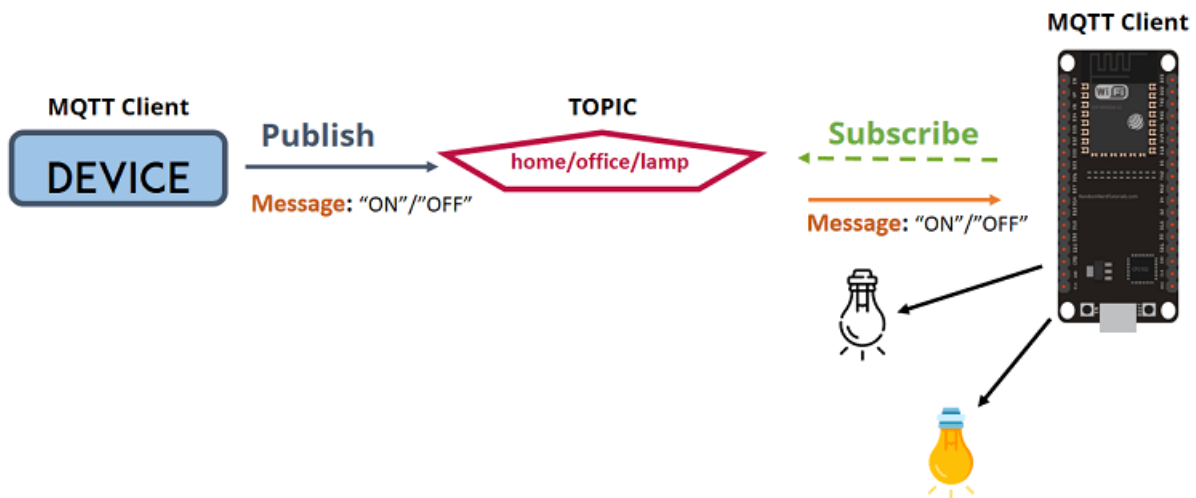

1. You have a device that published "on" and "off" message on the `home/office/lamp` topic.
2. You have a device that controls a lamp. And the device is subscribed to that topic: `home/office/lamp`.
3. So, when a new message is published on that topic, the subscriber received the "on" or "off" message and turns the lamp on or off.

Besides, there are two wildcard characters '+', and '#'. You can use the wildcard characters to subscribe similar topics at the same time easily.

'+' is single level wildcard; A '+' characters represents a single level of hierarchy, and is used between delimiters. For example, you can subscribe the topic `home/+/lamp` for all the lamps in a home.

4G IIoT LoRa Gateway

'#' is the multi-level wildcard; A '#' character represents a complete sub-tree of the hierarchy and must be the last character in a subscription topic string. For example, you can subscribe the topic "home/#" for all the related message in a home.

This product is provided with MQTT functionality, both MQTT borker and MQTT client functions are supported. You can configure it for your IoT application scanrio.

Go to **Field Communication > Data Interchange > MQTT** tab.

Play as a MQTT Broker

MQTT Broker Configuration	
Item	Setting
▶ Broker	<input type="checkbox"/> Enable
▶ Listening Port	<input type="text" value="1883"/> (1~65535)
▶ Authentication	<input type="checkbox"/> Enable
▶ Security	<input type="text" value="None"/> ▼

MQTT Broker Configuration		
Item	Value setting	Description
Broker	The box is unchecked by default.	Check the box to activate the MQTT Broker function.
Listening Port	1. An Optional setting. 2. 1883 is set by default	Specify a port as the listening port for MQTT broker. The MQTT broker will monitor the activity on that port and collect those valid packets from MQTT clients. If there is any MQTT client(s) that subscribing the received topic, the MQTT broker will forward the packet to the correspondig subscriber(s). Value Range: 1 ~ 65535.
Security	1. An Optional setting. 2. None is set by default	Select the security scheme for the MQTT packets. None: no encryption is involved for the MQTT packets. SSL/TLS: SSL/TLS encryption is applied for security. You have to further specify required certificate files. Note: If SSL/TLS is selected, the listen port will be changed to 8883 accordingly by default.
Certificate	1. An Optional setting. 2. None is set by default	Select CA File / CERT File / Key File from the dropdown lists. If you don't have available items in the dropdown list, you have to define or create it first. Please refer to Object Definition > Certificate > Trusted Certificate . CA File could be defined in Trusted Certificate List. CERT File could be defined in Trusted Client Certificate List. KEY File could be defined in Trusted Client Key List.
Authentication	1. An Optional setting. 2. The box is unchecked by default.	Check the box if user (account) authentication is required for subscribing the MQTT messages from the MQTT Broker. With the box checked, you can define up to five user accounts for permitted subscribers.

4G IIoT LoRa Gateway

Save	N/A	Click the Save button to save the settings.
-------------	-----	--

4G IIoT LoRa Gateway

Create/Edit User List

User List <input type="button" value="Add"/> <input type="button" value="Delete"/>			
ID	Username	Password	Action

When the **Add** button is applied, **User List Configuration** screen will appear.

User List Configuration <input type="button" value="Save"/> <input type="button" value="Undo"/>	
Item	Setting
▶ Username	<input type="text"/>
▶ Password	<input type="text"/>

Scheme Configuration		
Item	Value setting	Description
Username	A Must filled setting.	Specify a name as the identifier of the MQTT subscriber. Value Range: 1 ~ 32 characters.
Password	A Must filled setting.	Specify a password for the user account. Value Range: 1 ~ 32 characters.
Save	N/A	Click the Save button to save the settings.
Undo	N/A	Click the Undo button to cancel the changes.

Play as a MQTT Client

In addition to paly as a MQTT Borker, the gateway also support MQTT Client function. It can play as a MQTT client and publish message to MQTT borker, or subscribe interested topic(s) from MQTT Borker(s).

MQTT Client Function	
Item	Setting
▶ MQTT Client	<input type="checkbox"/> Enable

MQTT Broker Configuration		
Item	Value setting	Description
MQTT Client	The box is unchecked by default.	Check the box to activate the MQTT Client function. With the MQTT Client enabled, the gateway play as a MQTT client and publish message to MQTT borker, or subscribe interested topic(s) from MQTT Borker(s)
Save	N/A	Click the Save button to save the settings.

4G IIoT LoRa Gateway

Create/Edit MQTT Client List

MQTT Client List <input type="button" value="Add"/> <input type="button" value="Delete"/>							
ID	Connection Name	Address	Authentication	Security	Port	Enable	Action
1	Broker01	1.2.3.4	<input checked="" type="checkbox"/>	None	1883	<input checked="" type="checkbox"/>	<input type="button" value="Subscriptions Received List"/> <input type="button" value="Edit"/> <input type="checkbox"/> Select

When the **Add** button is applied, a sequence of configuration screens will appear. They are **MQTT Client Configuration**, **MQTT Message Configuration**, **Publish Message List**, and **Subscribe Message List**.

Besides, there is a “**Subscriptions Received List**” button for you to access the subscribed & received message list. When the “**Subscriptions Received List**” button is applied, a message list will appear, and you can browse it page by page, download the messages to a file, or delete the messages.

Define MQTT Client Configuration

MQTT Client Configuration	
Item	Setting
▶ Connection Name	<input type="text"/>
▶ Address	<input type="text"/>
▶ Port	<input type="text" value="1883"/> (1~65535)
▶ Authentication	<input type="checkbox"/>
▶ Security	<input type="text" value="None"/> ▼
▶ Client ID	<input type="text" value="005018758506"/>
▶ Keep Alive	<input type="text" value="60"/> (5~86400 sec)
▶ Enable	<input type="checkbox"/>

MQTT Client Configuration		
Item	Value setting	Description
Connection Name	The box is unchecked by default.	Specify a name as the identifier of the MQTT Client. It can be identified with the Broker Name, or interested message (topic) Value Range: 1 ~ 64 characters.
Address	1. A Must-filled setting. 2. Blank by default	Specify the host name or IP address of the MQTT broker that the client is going to publish message to it, or subscribe messages from it.
Port	1. An Optional setting. 2. 1883 is set by	Specify a port as the port for MQTT connection.

4G IIoT LoRa Gateway

	default	<u>Value Range:</u> 1 ~ 65535.
Security	1. An Optional setting. 2. None is set by default	Select the security scheme for the MQTT connection. None: no encryption is involved for the MQTT connection. SSL/TLS: SSL/TLS encryption is applied for security. You have to further specify required certificate files. Note: If SSL/TLS is selected, the listen port will be changed to 8883 accordingly by default.
Certificate	1. An Optional setting. 2. None is set by default	Select CA File / CERT File / Key File from the dropdown lists. If you don't have available items in the dropdown list, you have to define or create it first. Please refer to Object Definition > Certificate > Trusted Certificate . CA File could be defined in Trusted Certificate List. CERT File could be defined in Trusted Client Certificate List. KEY File could be defined in Trusted Client Key List.
Client ID	1. A Must-filled setting. 2. ID with device MAC is set by default	Specify an unique ID for the MQTT client. By default the MAC address is used as the ID string.
Authentication	1. An Optional setting. 2. The box is unchecked by default.	Check the box if user (account) authentication is required for subscribing the MQTT messages. With the box checked, you have to further specify Username and Password for the connection.
Username	A Must filled setting.	Specify a name as the identifier of the MQTT client. <u>Value Range:</u> 1 ~ 32 characters.
Password	A Must filled setting.	Specify a password for the user account. <u>Value Range:</u> 1 ~ 32 characters.
Keep Alive	1. An Optional setting. 2. 60 sec is set by default.	Specify a keep alive interval to keep the connection alive while the connection is idle. <u>Value Range:</u> 5 ~ 86400 sec.
Enable	The box is unchecked by default.	Check the box to activate this MQTT Client configuration
Save	N/A	Click the Save button to save the settings.
Undo	N/A	Click the Undo button to cancel the changes.
Back	N/A	Click the Back button to go back to previous configuration screen.

Define MQTT Message

You can define the Last Will Message, and optional Topic Prefix for publishing / subscribing MQTT messages.

4G IIoT LoRa Gateway

MQTT Message Configuration	
Item	Setting
▶ Last Will	<input checked="" type="checkbox"/> Enable
▶ Topic	<input type="text"/>
▶ Message	<input type="text"/>
▶ QoS	<input checked="" type="radio"/> 0 (At most once) <input type="radio"/> 1 (At least once) <input type="radio"/> 2 (Exactly once)
▶ Topic prefix (Optional)	<input type="text"/>

MQTT Message Configuration		
Item	Value setting	Description
Enable	The box is unchecked by default.	Check the box to activate this Last Will message configuration. If the box is checked, you have to further specify Topic, Message, and QoS settings. When the MQTT broker detected that the MQTT client is disconnected, it will send the Last Will message to the interested MQTT subscribers.
Topic	1. A Must-filled setting. 2. Blank by default	Specify the topic for the Last Will message. Value Range: 1 ~ 64 characters, including the topic level separator '/', but excluding the wildcards '+' and '#'.
Message	1. A Must-filled setting. 2. Blank by default	Specify the message content for the Last Will message. Value Range: 1 ~ 256 characters.
QoS	1. An Optional setting. 2. 0 (At most once) is set by default	Select the QoS type for the Last Will message. 0 (At most once): the message will be published only once, and the broker and subscribed client(s) take no additional steps to acknowledge the delivery, no matter it is received or not. 1 (At least once): the message will be published at least once until acknowledgement is received from the broker or subscribed client(s). 2 (Exactly once): the message will be published to subscriber(s) once in a two-level handshake to ensure only one copy of the message is received.
Topic prefix (Optional)	1. An Optional-filled setting. 2. Blank by default	Specify the topic prefix for MQTT message. Value Range: 1 ~ 64 characters.
Save	N/A	Click the Save button to save the settings.
Undo	N/A	Click the Undo button to cancel the changes.
Back	N/A	Click the Back button to go back to previous configuration screen.

4G IIoT LoRa Gateway

Publish Message List

Publish Message List <input type="button" value="Add"/> <input type="button" value="Delete"/>				
ID	Topic	QoS	Enable	Action

Up to 64 published messages will be shown in the message list. When the **Add** button is applied, **Publish Message Configuration** screen will appear.

Publish Message Configuration <input type="button" value="Save"/> <input type="button" value="Undo"/>	
Item	Setting
▶ Topic	<input type="text"/>
▶ Topics prefix	<input type="checkbox"/> Enable
▶ Message Style	Manual ▼
▶ Message	<input type="text"/>
▶ QoS	<input checked="" type="radio"/> 0 (At most once) <input type="radio"/> 1 (At least once) <input type="radio"/> 2 (Exactly once)
▶ Retained	<input type="checkbox"/> Enable
▶ Publish Behavior	<input type="checkbox"/> Auto Publish
▶ Enable	<input type="checkbox"/>

Publish Message Configuration		
Item	Value setting	Description
Topic	1. A Must-filled setting. 2. Blank by default	Specify the topic for the message to be published. Value Range: 1 ~ 64 characters, including the topic level separator '/', but excluding the wildcards '+' and '#'.
Topic prefix	The box is unchecked by default.	Check the box to add the predefined topic prefix into a MQTT message.
Message Style	1. An Optional-filled setting. 2. Manual is selected by default	Select a message style from the dropdown list. The supported styles are : Manual: The message is create manually, and you can specify the message content below. System Log: The message to be published are the System log of the device. Data Logging: The message to be published are the Data Logging recorded in the designated storage
Message	1. A Must-filled setting. 2. Blank by default	Specify the message content for the Manual publish message. Value Range: 1 ~ 256 characters.

4G IIoT LoRa Gateway

QoS	1. An Optional setting. 2. 0 (At most once) is set by default	Select the QoS type for publishing a message. 0 (At most once) : the message will be published only once, and the broker and subscribed client(s) take no additional steps to acknowledge the delivery, no matter it is received or not. 1 (At least once) : the message will be published at least once until acknowledgement is received from the broker or subscribed client(s). 2 (Exactly once) : the message will be published to subscriber(s) once in a two-level handshake to ensure only one copy of the message is received.
Retained	The box is unchecked by default.	Check the box to activate this message retaining function.
Publish Behavior	The box is unchecked by default.	Check the box(es) for the expected publish behavior: Auto Publish : auto publish a message with specified time interval (1~65535 sec). When the Message or Data variation more than <input type="checkbox"/> lines. : publish a new message that varies from previous one for specified changes. Note: if Message style is set to Manual, only Auto Publish is available.
Enable	The box is unchecked by default.	Check the box to activate this publish message configuration.
Save	N/A	Click the Save button to save the settings.
Undo	N/A	Click the Undo button to cancel the changes.
Back	N/A	Click the Back button to go back to previous configuration screen.

Subscribe Message List

Subscribe Message List
Add
Delete

ID	Topic	QoS	Enable	Action
----	-------	-----	--------	--------

Up to 64 subscribed messages will be shown in the message list. When the **Add** button is applied, **Subscribe Message Configuration** screen will appear.

Subscribe Message Configuration
Save
Undo

Item	Setting
▶ Topic	<input style="width: 100%; height: 30px;" type="text"/>
▶ Topics prefix	<input type="checkbox"/> Enable
▶ QoS	<input checked="" type="radio"/> 0 (At most once) <input type="radio"/> 1 (At least once) <input type="radio"/> 2 (Exactly once)
▶ Enable	<input type="checkbox"/>

Subscribe Message Configuration		
Item	Value setting	Description
Topic	1. A Must-filled setting.	Specify the topic for the message to be subscribed.

4G IIoT LoRa Gateway

	2. Blank by default	<u>Value Range:</u> 1 ~ 64 characters, including the topic level separator '/', and wildcards '+', '#.
Topic prefix	The box is unchecked by default.	Check the box to enable the topic prefix for subscribed message.
QoS	1. An Optional setting. 2. 0 (At most once) is set by default	Select the QoS type for subscribing a message. 0 (At most once): the message will be published only once, and the broker and subscribed client(s) take no additional steps to acknowledge the delivery, no matter it is received or not. 1 (At least once): the message will be published at least once until acknowledgement is received from the broker or subscribed client(s). 2 (Exactly once): the message will be published to subscriber(s) once in a two-level handshake to ensure only one copy of the message is received.
Enable	The box is unchecked by default.	Check the box to activate this subscribe message configuration
Save	N/A	Click the Save button to save the settings.
Undo	N/A	Click the Undo button to cancel the changes.
Back	N/A	Click the Back button to go back to previous configuration screen.

Chapter 5 Security

5.1 VPN

A virtual private network (VPN) extends a private network across a public network, such as the Internet. It enables a computer to send and receive data across shared or public networks as if it were directly connected to the private network, while benefitting from the functionality, security and management policies of the private network. This is done by establishing a virtual point-to-point connection through the use of dedicated connections, encryption, or a combination of the two. The tunnel technology supports data confidentiality, data origin authentication and data integrity of network information by utilizing encapsulation protocols, encryption algorithms, and hashing algorithms.

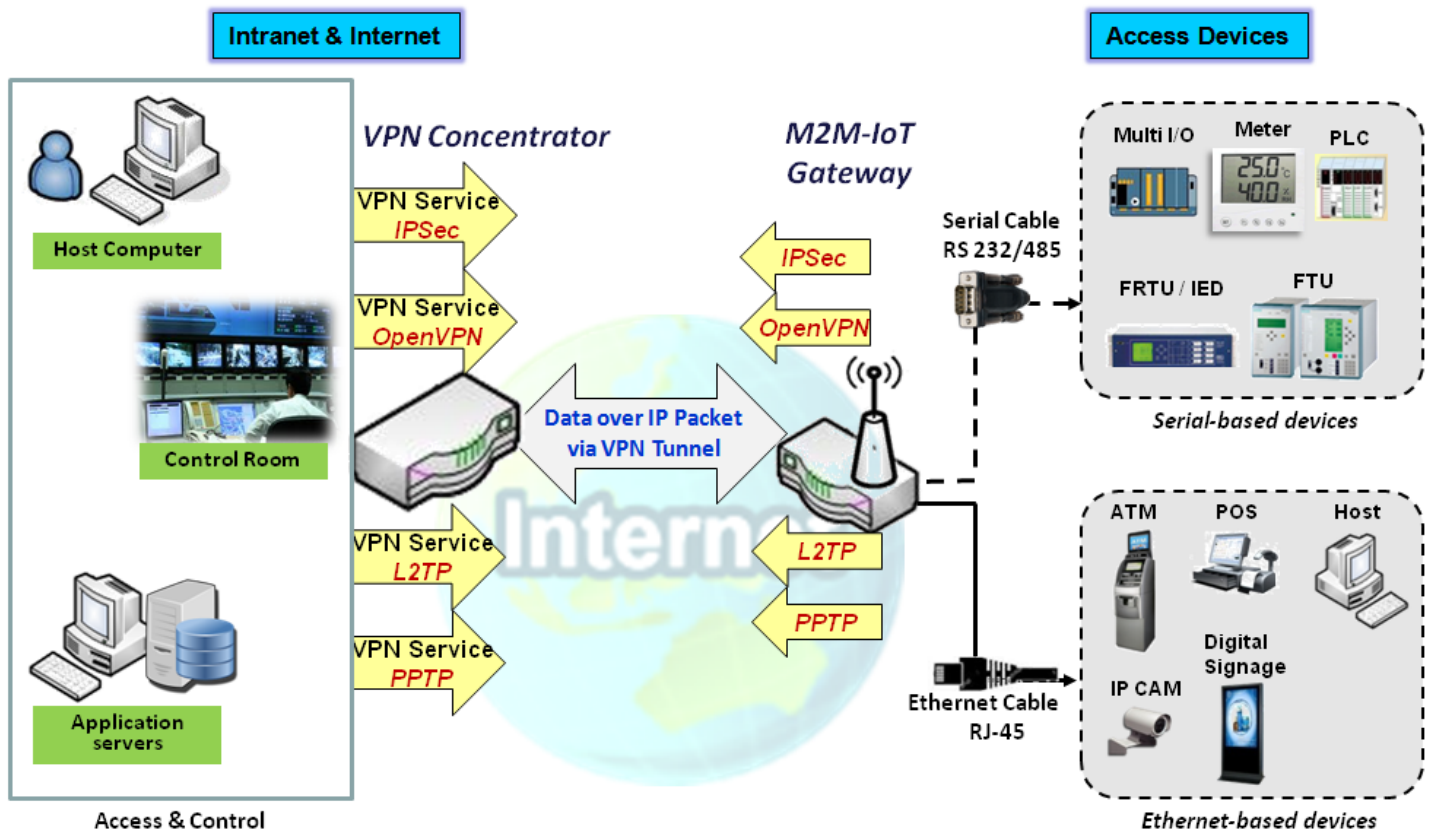

The product series supports different tunneling technologies to establish secure tunnels between multiple sites for data transferring, such as IPsec, OpenVPN, L2TP (over IPsec), PPTP and GRE. Besides, some advanced functions, like Full Tunnel, Tunnel Failover, Tunnel Load Balance, NetBIOS over IPsec, NAT Traversal and Dynamic VPN, are also supported.

4G IIoT LoRa Gateway

5.1.1 IPsec

Internet Protocol Security (IPsec) is a protocol suite for securing Internet Protocol (IP) communications by authenticating and encrypting each IP packet of a communication session. IPsec includes protocols for establishing mutual authentication between agents at the beginning of the session and negotiation of cryptographic keys to be used during the session.

An IPsec VPN tunnel is established between IPsec client and server. Sometimes, we call the IPsec VPN client as the initiator and the IPsec VPN server as the responder. This gateway can be configured as different roles and establish number of tunnels with various remote devices. Before going to setup the VPN connections, you may need to decide the scenario type for the tunneling.

IPsec Tunnel Scenarios

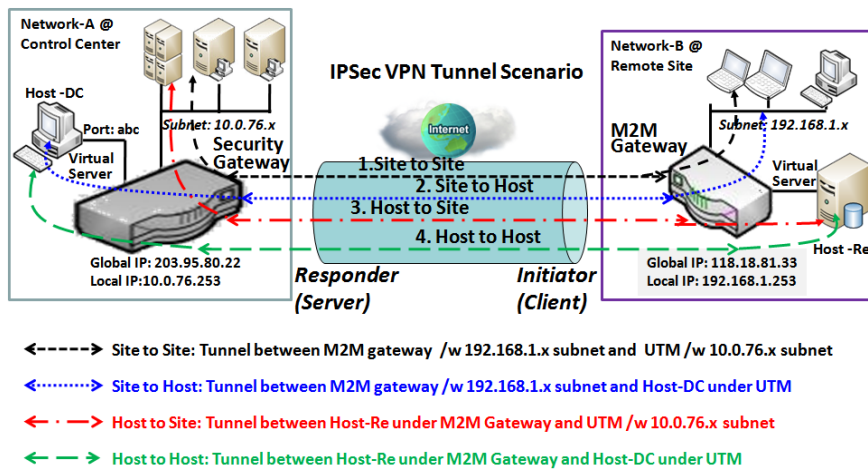

To build IPsec tunnel, you need to fill in remote gateway global IP, and optional subnet if the hosts behind IPsec peer can access to remote site or hosts. Under such configuration, there are four scenarios:

Site to Site: You need to setup remote gateway IP and subnet of both gateways. After the IPsec tunnel established, hosts behind both gateways can communication each other through the tunnel.

Site to Host: Site to Host is suitable for tunneling between clients in a subnet and an application server (host). As in the diagram, the clients behind the M2M gateway can access to the host "Host-DC" located in the control center through Site to Host VPN tunnel.

Host to Site: On the contrast, for a single host (or mobile user to) to access the resources located in an intranet, the Host to Site scenario can be applied.

Host to Host: Host to Host is a special configuration for building a VPN tunnel between two single hosts.

4G IIoT LoRa Gateway

IPSec Setting

Go to **Security > VPN > IPSec** tab.

The IPSec Setting allows user to create and configure IPSec tunnels.

Enable IPSec

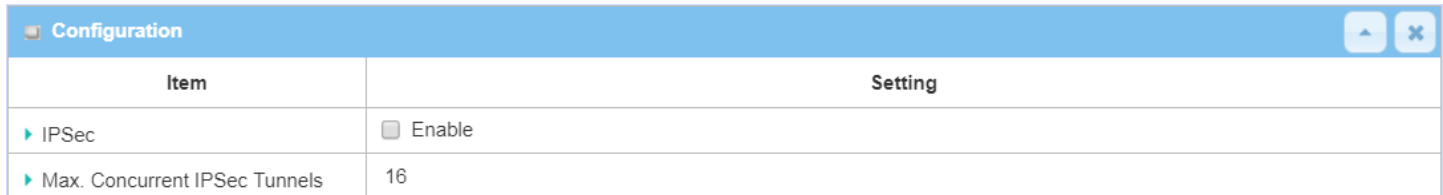

Item	Setting
▶ IPSec	<input type="checkbox"/> Enable
▶ Max. Concurrent IPSec Tunnels	16

Configuration Window		
Item	Value setting	Description
IPsec	Unchecked by default	Click the Enable box to enable IPSec function.
Max. Concurrent IPSec Tunnels	Depends on Product specification.	The specified value will limit the maximum number of simultaneous IPSec tunnel connection. The default value can be different for the purchased model.
Save	N/A	Click Save to save the settings
Undo	N/A	Click Undo to cancel the settings

Create/Edit IPSec tunnel

Ensure that the IPSec enable box is checked to enable before further configuring the IPSec tunnel settings.

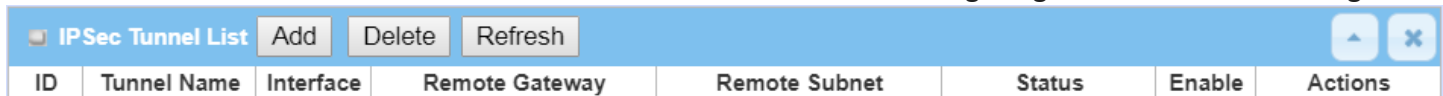

ID	Tunnel Name	Interface	Remote Gateway	Remote Subnet	Status	Enable	Actions
----	-------------	-----------	----------------	---------------	--------	--------	---------

When **Add/Edit** button is applied, a series of configuration screens will appear. They are Tunnel Configuration, Local & Remote Configuration, Authentication, IKE Phase, IKE Proposal Definition, IPSec Phase, and IPSec Proposal Definition. You have to configure the tunnel details for both local and remote VPN devices.

4G IIoT LoRa Gateway

Tunnel Configuration	
Item	Setting
▶ Tunnel	<input type="checkbox"/> Enable
▶ Tunnel Name	IPSec #1
▶ Interface	WAN1 ▼
▶ Tunnel Scenario	Site-to-Site(Tunnel mode) ▼
▶ Tunnel TCP MSS	Auto ▼ 0 (64~1500 Bytes)
▶ Encapsulation Protocol	ESP ▼
▶ IKE Version	v1 ▼

Tunnel Configuration Window		
Item	Value setting	Description
Tunnel	Unchecked by default	Check the Enable box to activate the IPSec tunnel
Tunnel Name	1. A Must fill setting 2. String format can be any text	Enter a tunnel name. Enter a name that is easy for you to identify. Value Range: 1 ~ 19 characters.
Interface	1. A Must fill setting 2. WAN 1 is selected by default	Select the interface on which IPSec tunnel is to be established. It can be the available WAN and LAN interfaces.
Tunnel Scenario	1. A Must fill setting 2. Site to site is selected by default	Select an IPSec tunneling scenario from the dropdown box for your application. Select Site-to-Site , Site-to-Host , Host-to-Site , or Host-to-Host . If LAN interface is selected, only Host-to-Host scenario is available. With Site-to-Site or Site-to-Host or Host-to-Site , IPSec operates in tunnel mode. The difference among them is the number of subnets. With Host-to-Host , IPSec operates in transport mode.
Tunnel TCP MSS	1. An optional setting 2. Auto is set by default	Select from the dropdown box to define the size of Tunnel TCP MSS. Select Auto , and all devices will adjust this parameter automatically. Select Manual , and specify an expected value for Tunnel TCP MSS. Value Range: 64 ~ 1500 bytes.
Encapsulation Protocol	1. A Must fill setting 2. ESP is selected by default	Select the Encapsulation Protocol from the dropdown box for this IPSec tunnel. Available encapsulations are ESP and AH .
IKE Version	1. A Must fill setting 2. v1 is selected by default	Specify the IKE version for this IPSec tunnel. Select v1 or v2 .

4G IIoT LoRa Gateway

Local & Remote Configuration				
Item	Setting			
▶ Local Subnet List	ID	Subnet IP Address	Subnet Mask	Actions
	1	<input type="text" value="192.168.66.0"/>	<input type="text" value="255.255.255.0/(24)"/>	<input type="button" value="Delete"/>
	<input type="button" value="Add"/>			
▶ Remote Subnet List	ID	Subnet IP Address	Subnet Mask	Actions
	1	<input type="text"/>	<input type="text" value="255.255.255.0/(24)"/>	<input type="button" value="Delete"/>
	<input type="button" value="Add"/>			
▶ Remote Gateway	<input type="text"/> (IP Address/FQDN)			

Local & Remote Configuration Window		
Item	Value setting	Description
Local Subnet List	A Must fill setting	<p>Specify the Local Subnet IP address and Subnet Mask. Click the Add or Delete button to add or delete a Local Subnet.</p> <p>Note_1: When Dynamic VPN option in Tunnel Scenario is selected, there will be only one subnet available. Note_2: When Host-to-Site or Host-to-Host option in Tunnel Scenario is selected, Local Subnet will not be available. Note_3: When Hub and Spoke option in Hub and Spoke is selected, there will be only one subnet available.</p>
Remote Subnet List	A Must fill setting	<p>Specify the Remote Subnet IP address and Subnet Mask. Click the Add or Delete button to add or delete Remote Subnet setting.</p>
Remote Gateway	<ol style="list-style-type: none"> A Must fill setting. Format can be a ipv4 address or FQDN 	Specify the Remote Gateway.

Authentication	
Item	Setting
▶ Key Management	<input type="text" value="IKE+Pre-shared Key"/> (Min. 8 characters)
▶ Local ID	Type: <input type="text" value="User Name"/> ID: <input type="text"/> (Optional)
▶ Remote ID	Type: <input type="text" value="User Name"/> ID: <input type="text"/>

Authentication Configuration Window		
Item	Value setting	Description
Key Management	<ol style="list-style-type: none"> A Must fill setting Pre-shared Key 8 to 32 characters. 	<p>Select Key Management from the dropdown box for this IPsec tunnel.</p> <p>IKE+Pre-shared Key: user needs to set a key (8 ~ 32 characters). IKE+X.509: user needs Certificate to authenticate. IKE+X.509 will be available only when Certificate has been configured properly. Refer to Certificate section of this manual and also Object Definition > Certificate in web-based utility.</p>
Local ID	An optional setting	<p>Specify the Local ID for this IPsec tunnel to authenticate.</p> <p>Select User Name for Local ID and enter the username. The username may include but can't be all numbers.</p> <p>Select FQDN for Local ID and enter the FQDN.</p> <p>Select User@FQDN for Local ID and enter the User@FQDN.</p>

4G IIoT LoRa Gateway

	Select Key ID for Local ID and enter the Key ID (English alphabet or number).
Remote ID	An optional setting Specify the Remote ID for this IPSec tunnel to authenticate. Select User Name for Remote ID and enter the username. The username may include but can't be all numbers. Select FQDN for Local ID and enter the FQDN. Select User@FQDN for Remote ID and enter the User@FQDN. Select Key ID for Remote ID and enter the Key ID (English alphabet or number). Note: Remote ID will be not available when Dynamic VPN option in Tunnel Scenario is selected.

4G IIoT LoRa Gateway

IKE Phase	
Item	Setting
▶ Negotiation Mode	Main Mode ▾
▶ X-Auth	None ▾ X-Auth Account (Optional) User Name : <input type="text"/> Password : <input type="text"/>
▶ Dead Peer Detection (DPD)	<input checked="" type="checkbox"/> Enable Timeout : <input type="text" value="180"/> (seconds) Delay : <input type="text" value="30"/> (seconds)
▶ Phase1 Key Life Time	<input type="text" value="3600"/> (seconds) (Max. 86400)

IKE Phase Window		
Item	Value setting	Description
Negotiation Mode	Main Mode is set by default default	Specify the Negotiation Mode for this IPsec tunnel. Select Main Mode or Aggressive Mode .
X-Auth	None is selected by default	Specify the X-Auth role for this IPsec tunnel. Select Server, Client, or None. Selected None no X-Auth authentication is required. Selected Server this gateway will be an X-Auth server. Click on the X-Auth Account button to create remote X-Auth client account. Selected Client this gateway will be an X-Auth client. Enter User name and Password to be authenticated by the X-Auth server gateway. Note: X-Auth Client will not be available for Dynamic VPN option selected in Tunnel Scenario.
Dead Peer Detection (DPD)	1. Checked by default 2. Default Timeout 180s and Delay 30s	Click Enable box to enable DPD function. Specify the Timeout and Delay time in seconds. Value Range: 0 ~ 999 seconds for Timeout and Delay.
Phase1 Key Life Time	1. A Must fill setting 2. Default 3600s 3. Max. 86400s	Specify the Phase1 Key Life Time. Value Range: 30 ~ 86400.

IKE Proposal Definition				
ID	Encryption	Authentication	DH Group	Definition
1	AES-128 ▾	SHA1 ▾	Group 2 ▾	<input checked="" type="checkbox"/> Enable
2	AES-128 ▾	MD5 ▾	Group 2 ▾	<input checked="" type="checkbox"/> Enable
3	DES ▾	SHA1 ▾	Group 2 ▾	<input checked="" type="checkbox"/> Enable
4	3DES ▾	SHA1 ▾	Group 2 ▾	<input checked="" type="checkbox"/> Enable

IKE Proposal Definition Window		
Item	Value setting	Description
IKE Proposal Definition	A Must fill setting	Specify the Phase 1 Encryption method. It can be DES / 3DES / AES-128 / AES-192 / AES-256. Specify the Authentication method. It can be None / MD5 / SHA1 / SHA2-256. Specify the DH Group. It can be None / Group1 / Group2 / Group5 / Group14 / Group15 / Group16 / Group17 / Group18. Check Enable box to enable this setting

4G IIoT LoRa Gateway

IPSec Phase	
Item	Setting
Phase2 Key Life Time	<input type="text" value="28800"/> (seconds) (Max. 86400)

IPSec Phase Window		
Item	Value setting	Description
Phase2 Key Life Time	1. A Must fill setting 2. 28800s is set by default 3. Max. 86400s	Specify the Phase2 Key Life Time in second. Value Range: 30 ~ 86400.

IPSec Proposal Definition				
ID	Encryption	Authentication	PFS Group	Definition
1	<input type="text" value="AES-128"/>	<input type="text" value="SHA1"/>	<input type="text" value="Group 2"/>	<input checked="" type="checkbox"/> Enable
2	<input type="text" value="AES-128"/>	<input type="text" value="MD5"/>		<input checked="" type="checkbox"/> Enable
3	<input type="text" value="DES"/>	<input type="text" value="SHA1"/>		<input checked="" type="checkbox"/> Enable
4	<input type="text" value="3DES"/>	<input type="text" value="SHA1"/>		<input checked="" type="checkbox"/> Enable

IPSec Proposal Definition Window		
Item	Value setting	Description
IPSec Proposal Definition	A Must fill setting	Specify the Encryption method. It can be DES / 3DES / AES-128 / AES-192 / AES-256. Note: None is available when Encapsulation Protocol is set as AH . Specify the Authentication method. It can be None / MD5 / SHA1 / SHA2-256. Note: None and SHA2-256 are available only when Encapsulation Protocol is set as ESP ; they are not available for AH Encapsulation. Specify the PFS Group. It can be None / Group1 / Group2 / Group5 / Group14 / Group15 / Group16 / Group17 / Group18. Click Enable to enable this setting
Save	N/A	Click Save to save the settings
Undo	N/A	Click Undo to cancel the settings
Back	N/A	Click Back to return to the previous page.

4G IIoT LoRa Gateway

Create/Edit Dynamic VPN Server List



Similar to create an IPsec VPN Tunnel for site/host to site/host scenario, when **Add / Edit** button is applied a series of configuration screen will appear. They are Tunnel Configuration, Local & Remote Configuration, Authentication, IKE Phase, IKE Proposal Definition, IPsec Phase, and IPsec Proposal Definition. You have to configure the tunnel details for the gateway as a Dynamic VPN server.

Note: For the purchased gateway, you can configure one Dynamic VPN server for each WAN interface.

Tunnel Configuration	
Item	Setting
Tunnel	<input type="checkbox"/> Enable
Tunnel Name	Dynamic IPsec1
Interface	WAN1 ▼
Tunnel Scenario	Tunnel Mode ▼
Encapsulation Protocol	ESP ▼
IKE Version	v1 ▼

Tunnel Configuration Window		
Item	Value setting	Description
Tunnel	Unchecked by default	Check the Enable box to activate the Dynamic IPsec VPN tunnel.
Tunnel Name	1. A Must fill setting 2. String format can be any text	Enter a tunnel name. Enter a name that is easy for you to identify. Value Range: 1 ~ 19 characters.
Interface	1. A Must fill setting 2. WAN 1 is selected by default	Select WAN interface on which IPsec tunnel is to be established.
Tunnel Scenario	1. A Must fill setting 2. Tunnel Mode is selected by default	Select the Dynamic IPsec tunneling scenario. It can be Tunnel Mode or Transport Mode .
Encapsulation Protocol	1. A Must fill setting 2. ESP is selected by default	Select the Encapsulation Protocol from the dropdown box for this IPsec tunnel. Available encapsulations are ESP and AH .
IKE Version	1. A Must fill setting 2. v1 is selected by default	Specify the IKE version for this IPsec tunnel.

Local & Remote Configuration	
Item	Setting
Local Subnet	192.168.66.0
Local Netmask	255.255.255.0(/24) ▼

Local & Remote Configuration Window

4G IIoT LoRa Gateway

Item	Value setting	Description
Local Subnet	A Must fill setting	Specify the Local Subnet IP address.
Local Netmask	A Must fill setting	Specify the Local Subnet Mask.

Authentication	
Item	Setting
▶ Key Management	IKE+Pre-shared Key ▼ <input type="text"/> (Min. 8 characters)
▶ Local ID	Type: User Name ▼ ID: <input type="text"/> (Optional)
▶ Remote ID	Type: User Name ▼ ID: <input type="text"/>

Authentication Configuration Window		
Item	Value setting	Description
Key Management	1. A Must fill setting 2. Pre-shared Key 8 to 32 characters.	Select Key Management from the dropdown box for this IPSec tunnel. IKE+Pre-shared Key : user needs to set a key (8 ~ 32 characters).
Local ID	An optional setting	Specify the Local ID for this IPSec tunnel to authenticate. Select User Name for Local ID and enter the username. The username may include but can't be all numbers. Select FQDN for Local ID and enter the FQDN. Select User@FQDN for Local ID and enter the User@FQDN. Select Key ID for Local ID and enter the Key ID (English alphabet or number).
Remote ID	An optional setting	Specify the Remote ID for this IPSec tunnel to authenticate. Select User Name for Remote ID and enter the username. The username may include but can't be all numbers. Select FQDN for Local ID and enter the FQDN. Select User@FQDN for Remote ID and enter the User@FQDN. Select Key ID for Remote ID and enter the Key ID (English alphabet or number). Note: Remote ID will be not available when Dynamic VPN option in Tunnel Scenario is selected.

For the rest IKE Phase, IKE Proposal Definition, IPSec Phase, and IPSec Proposal Definition settings, they are the same as that of creating an IPSec Tunnel described in previous section. Please refer to the related description.

4G IIoT LoRa Gateway

5.1.2 OpenVPN

OpenVPN is an application that implements virtual private network (VPN) techniques for creating secure point-to-point or site-to-site connections in routed or bridged configurations and remote access facilities. It uses a custom security protocol that utilizes SSL/TLS for key exchange. It is capable of traversing network address translators (NATs) and firewalls.

OpenVPN allows peers to authenticate each other using a Static Key (pre-shared key) or certificates. When used in a multi-client-server configuration, it allows the server to release an authentication certificate for every client, using signature and certificate authority. It uses the OpenSSL encryption library extensively, as well as the SSLv3/TLSv1 protocol, and contains many security and control features.

OpenVPN Tunneling is a Client and Server based tunneling technology. The OpenVPN Server must have a Static IP or a FQDN, and maintain a Client list. The OpenVPN Client may be a mobile user or mobile site with public IP or private IP, and requesting the OpenVPN tunnel connection. The product supports both OpenVPN Server and OpenVPN Client features to meet different application requirements.

There are two OpenVPN connection scenarios. They are the TAP and TUN scenarios. The product can create either a layer-3 based IP tunnel (TUN), or a layer-2 based Ethernet TAP that can carry any type of Ethernet traffic. In addition to configuring the device as a Server or Client, you have to specify which type of OpenVPN connection scenario is to be adopted.

OpenVPN TUN Scenario

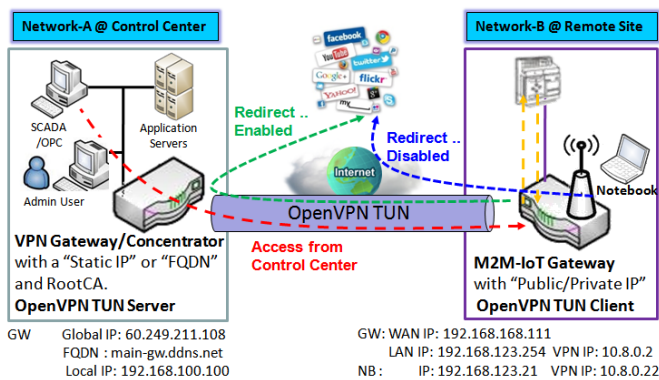

1. M2M-IoT Gateway (as OpenVPN TUN Client) connects to peer VPN Gateway/Concentrator (as OpenVPN TUN Server).
2. M2M-IoT Gateway will be assigned 10.8.0.2 IP Address after OpenVPN TUN Connection established. (10.8.0.x is a virtual subnet)
3. Local networked device will get a virtual IP 10.8.0.x if its traffic goes through the OpenVPN TUN connection (when NAT disabled & Redirect Internet Traffic enabled).
4. SCADA Server in Control Center can access remote attached device(s) with the assigned IP Address 10.8.0.2.

solution.

The term "TUN" mode is referred to routing mode and operates with layer 3 packets. In routing mode, the VPN client is given an IP address on a different subnet than the local LAN under the OpenVPN server. This virtual subnet is created for connecting to any remote VPN computers. In routing mode, the OpenVPN server creates a "TUN" interface with its own IP address pool which is different to the local LAN. Remote hosts that dial-in will get an IP address inside the virtual network and will have access only to the server where OpenVPN resides.

If you want to offer remote access to a VPN server from client(s), and inhibit the access to remote LAN resources under VPN server, OpenVPN TUN mode is the simplest

As shown in the diagram, the M2M-IoT Gateway is configured as an OpenVPN TUN Client, and connects to an

4G IIoT LoRa Gateway

OpenVPN UN Server. Once the OpenVPN TUN connection is established, the connected TUN client will be assigned a virtual IP (10.8.0.2) which is belong to a virtual subnet that is different to the local subnet in Control Center. With such connection, the local networked devices will get a virtual IP 10.8.0.x if its traffic goes through the OpenVPN TUN connection when Redirect Internet Traffic settings is enabled; Besides, the SCADA Server in Control Center can access remote attached serial device(s) with the virtual IP address (10.8.0.2).

OpenVPN TAP Scenario

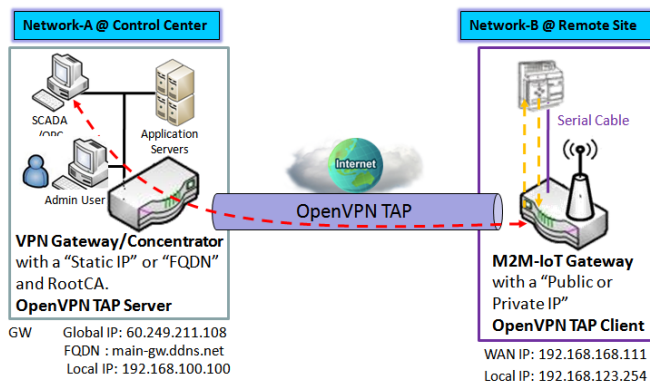

1. M2M-IoT Gateway (as OpenVPN TAP Client) connects to peer VPN Gateway/Concentrator (as OpenVPN TAP Server).
2. M2M-IoT Gateway will be assigned **192.168.100.210** IP Address after OpenVPN TAP Connection established. **(same subnet as in Control Center)**
3. SCADA Server in Control Center can access remote attached device(s) with the assigned IP Address 192.168.100.210.

The term "TAP" is referred to bridge mode and operates with layer 2 packets. In bridge mode, the VPN client is given an IP address on the same subnet as the LAN resided under the OpenVPN server. Under such configuration, the OpenVPN client can directly access to the resources in LAN. If you want to offer remote access to the entire remote LAN for VPN client(s), you have to setup OpenVPN in "TAP" bridge mode.

As shown in the diagram, the M2M-IoT Gateway is configured as an OpenVPN TAP Client, and connects to an OpenVPN TAP Server. Once the OpenVPN TAP connection is established, the connected TAP client will be assigned a virtual IP (192.168.100.210) which is the same subnet as

that of local subnet in Control Center. With such connection, the SCADA Server in Control Center can access remote attached serial device(s) with the virtual IP address (192.168.100.210).

4G IIoT LoRa Gateway

Open VPN Setting

Go to **Security > VPN > OpenVPN** tab.

The OpenVPN setting allows user to create and configure OpenVPN tunnels.

Enable OpenVPN

Enable OpenVPN and select an expected configuration, either server or client, for the gateway to operate.

Configuration	
Item	Setting
▶ OpenVPN	<input checked="" type="checkbox"/> Enable
▶ Server / Client	Server ▼

Configuration		
Item	Value setting	Description
OpenVPN	The box is unchecked by default	Check the Enable box to activate the OpenVPN function.
Server/Client	Server Configuration is selected by default.	When Server is selected, as the name indicated, server configuration will be displayed below for further setup. When Client is selected, you can specify the client settings in another client configuration window.

4G IIoT LoRa Gateway

As an OpenVPN Server

If **Server** is selected, an OpenVPN Server Configuration screen will appear. **OpenVPN Server Configuration** window can let you enable the OpenVPN server function, specify the virtual IP address of OpenVPN server, when remote OpenVPN clients dial in, and the authentication protocol.

The OpenVPN Server supports up to 4 TUN / TAP tunnels at the same time.

OpenVPN Server Configuration	
Item	Setting
▶ OpenVPN Server	<input type="checkbox"/> Enable
▶ Protocol	TCP ▼
▶ Port	4430
▶ Tunnel Scenario	TUN ▼
▶ Authorization Mode	TLS ▼ CA Cert.: amit-IDG761AM-JH.crt ▼ Server Cert.: LocalCert1 ▼
▶ Server Virtual IP	10.8.0.0
▶ DHCP-Proxy Mode	<input checked="" type="checkbox"/> Enable
▶ IP Pool	Starting Address: <input type="text"/> ~ Ending Address: <input type="text"/>
▶ Gateway	<input type="text"/>
▶ Netmask	255.255.255.0(/24) ▼
▶ Redirect Default Gateway	<input type="checkbox"/> Enable
▶ Encryption Cipher	Blowfish ▼
▶ Hash Algorithm	SHA-1 ▼
▶ LZO Compression	Adaptive ▼
▶ Persist Key	<input checked="" type="checkbox"/> Enable
▶ Persist Tun	<input checked="" type="checkbox"/> Enable
▶ Advanced Configuration	Edit

OpenVPN Server Configuration		
Item	Value setting	Description
OpenVPN Server	The box is unchecked by default.	Click the Enable to activate OpenVPN Server functions.
Protocol	<ol style="list-style-type: none"> A Must filled setting By default TCP is selected. 	Define the selected Protocol for connecting to the OpenVPN Server. <ul style="list-style-type: none"> Select TCP, or UDP -> The TCP protocol will be used to access the OpenVPN Server, and Port will be set as 4430 automatically.

4G IIoT LoRa Gateway

		<ul style="list-style-type: none"> • Select UDP <p>-> The UDP protocol will be used to access the OpenVPN Server, and Port will be set as 1194 automatically.</p>
Port	<ol style="list-style-type: none"> 1. A Must filled setting 2. By default 4430 is set. 	<p>Specify the Port for connecting to the OpenVPN Server.</p> <p>Value Range: 1 ~ 65535.</p>
Tunnel Scenario	<ol style="list-style-type: none"> 1. A Must filled setting 2. By default TUN is selected. 	<p>Specify the type of Tunnel Scenario for connecting to the OpenVPN Server. It can be TUN for TUN tunnel scenario, or TAP for TAP tunnel scenario.</p>
Authorization Mode	<ol style="list-style-type: none"> 1. A Must filled setting 2. By default TLS is selected. 	<p>Specify the authorization mode for the OpenVPN Server.</p> <ul style="list-style-type: none"> • TLS <p>->The OpenVPN will use TLS authorization mode, and the following items CA Cert., Server Cert. and DH PEM will be displayed. CA Cert. could be generated in Certificate. Refer to Object Definition > Certificate > Trusted Certificate. Server Cert. could be generated in Certificate. Refer to Object Definition > Certificate > My Certificate.</p> <ul style="list-style-type: none"> • Static Key <p>->The OpenVPN will use static key (pre-shared) authorization mode, and the following items Local Endpoint IP Address, Remote Endpoint IP Address and Static Key will be displayed. Note: Static Key will be available only when TUN is chosen in Tunnel Scenario.</p>
Local Endpoint IP Address	A Must filled setting	<p>Specify the virtual Local Endpoint IP Address of this OpenVPN gateway.</p> <p>Value Range: The IP format is 10.8.0.x, the range of x is 1~254.</p> <p>Note: Local Endpoint IP Address will be available only when Static Key is chosen in Authorization Mode.</p>
Remote Endpoint IP Address	A Must filled setting	<p>Specify the virtual Remote Endpoint IP Address of the peer OpenVPN gateway.</p> <p>Value Range: The IP format is 10.8.0.x, the range of x is 1~254.</p> <p>Note: Remote Endpoint IP Address will be available only when Static Key is chosen in Authorization Mode.</p>
Static Key	A Must filled setting	<p>Specify the Static Key.</p> <p>Note: Static Key will be available only when Static Key is chosen in Authorization Mode.</p>
Server Virtual IP	A Must filled setting	<p>Specify the Server Virtual IP.</p> <p>Value Range: The IP format is 10.y.0.0, the range of y is 1~254.</p> <p>Note: Server Virtual IP will be available only when TLS is chosen in Authorization Mode.</p>
DHCP-Proxy Mode	<ol style="list-style-type: none"> 1. A Must filled setting 2. The box is checked by default. 	<p>Check the Enable box to activate the DHCP-Proxy Mode.</p> <p>Note: DHCP-Proxy Mode will be available only when TAP is chosen in Tunnel Device.</p>
IP Pool	A Must filled setting	<p>Specify the virtual IP pool setting for the OpenVPN server. You have to specify the Starting Address and Ending Address as the IP address pool for the OpenVPN clients.</p> <p>Note: IP Pool will be available only when TAP is chosen in Tunnel Device, and DHCP-Proxy Mode is unchecked (disabled).</p>
Gateway	A Must filled setting	<p>Specify the Gateway setting for the OpenVPN server. It will be assigned to the connected OpenVPN clients.</p> <p>Note: Gateway will be available only when TAP is chosen in Tunnel Device, and DHCP-Proxy Mode is unchecked (disabled).</p>
Netmask	By default - select one - is selected.	<p>Specify the Netmask setting for the OpenVPN server. It will be assigned to the connected OpenVPN clients.</p> <p>Value Range: 255.255.255.0/24 (only support class C)</p>

4G IIoT LoRa Gateway

		Note_1: Netmask will be available when TAP is chosen in Tunnel Device, and DHCP-Proxy Mode is unchecked (disabled). Note_2: Netmask will also be available when TUN is chosen in Tunnel Device.
Redirect Default Gateway	1. An Optional setting. 2. The box is unchecked by default.	Check the Enable box to activate the Redirect Default Gateway function.
Encryption Cipher	1. A Must filled setting. 2. By default Blowfish is selected.	Specify the Encryption Cipher from the dropdown list. It can be Blowfish/AES-256/AES-192/AES-128/None .
Hash Algorithm	By default SHA-1 is selected.	Specify the Hash Algorithm from the dropdown list. It can be SHA-1/MD5/MD4/SHA2-256/SHA2-512/None/Disable .
LZO Compression	By default Adaptive is selected.	Specify the LZO Compression scheme. It can be Adaptive/YES/NO/Default .
Persis Key	1. An Optional setting. 2. The box is checked by default.	Check the Enable box to activate the Persis Key function.
Persis Tun	1. An Optional setting. 2. The box is checked by default.	Check the Enable box to activate the Persis Tun function.
Advanced Configuration	N/A	Click the Edit button to specify the Advanced Configuration setting for the OpenVPN server. If the button is clicked, Advanced Configuration will be displayed below.
Save	N/A	Click Save to save the settings.
Undo	N/A	Click X to cancel the changes and return to last page.

4G IIoT LoRa Gateway

When **Advanced Configuration** is selected, an OpenVPN Server Advanced Configuration screen will appear.

OpenVPN Server Advanced Configuration
✕

Item	Setting
▶ TLS Cipher	<input type="text" value="None"/>
▶ TLS Auth. Key	<input style="height: 30px;" type="text"/> (Optional)
▶ Client to Client	<input checked="" type="checkbox"/> Enable
▶ Duplicate CN	<input checked="" type="checkbox"/> Enable
▶ Tunnel MTU	<input type="text" value="1500"/>
▶ Tunnel UDP Fragment	<input type="text" value="0"/>
▶ Tunnel UDP MSS-Fix	<input type="checkbox"/> Enable
▶ CCD-Dir Default File	<input style="height: 30px;" type="text"/>
▶ Client Connection Script	<input style="height: 30px;" type="text"/>
▶ Additional Configuration	<input style="height: 30px;" type="text"/>

OpenVPN Server Advanced Configuration		
Item	Value setting	Description
TLS Cipher	1. A Must filled setting. 2. TLS-RSA-WITH-AES128-SHA is selected by default	Specify the TLS Cipher from the dropdown list. It can be None / TLS-RSA-WITH-RC4-MD5 / TLS-RSA-WITH-AES128-SHA / TLS-RSA-WITH-AES256-SHA / TLS-DHE-DSS-AES128-SHA / TLS-DHE-DSS-AES256-SHA . Note: TLS Cipher will be available only when TLS is chosen in Authorization Mode.
TLS Auth. Key	1. An Optional setting. 2. String format: any text	Specify the TLS Auth. Key . Note: TLS Auth. Key will be available only when TLS is chosen in Authorization Mode.
Client to Client	The box is checked by default	Check the Enable box to enable the traffics among different OpenVPN Clients. Note: Client to Client will be available only when TLS is chosen in Authorization Mode
Duplicate CN	The box is checked by default	Check the Enable box to activate the Duplicate CN function. Note: Duplicate CN will be available only when TLS is chosen in Authorization Mode
Tunnel MTU	1. A Must filled setting 2. The value is 1500 by default	Specify the Tunnel MTU . Value Range: 0 ~ 1500.
Tunnel UDP	1. A Must filled setting	Specify the Tunnel UDP Fragment . By default, it is equal to Tunnel MTU .

4G IIoT LoRa Gateway

Fragment	2. The value is 1500 by default	<i>Value Range:</i> 0 ~ 1500. Note: Tunnel UDP Fragment will be available only when UDP is chosen in Protocol.
Tunnel UDP MSS-Fix	1. An Optional setting. 2. The box is unchecked by default.	Check the Enable box to activate the Tunnel UDP MSS-Fix Function. Note: Tunnel UDP MSS-Fix will be available only when UDP is chosen in Protocol.
CCD-Dir Default File	1. An Optional setting. 2. String format: any text	Specify the CCD-Dir Default File . <i>Value Range:</i> 0 ~ 256 characters.
Client Connection Script	1. An Optional setting. 2. String format: any text	Specify the Client Connection Script . <i>Value Range:</i> 0 ~ 256 characters.
Additional Configuration	1. An Optional setting. 2. String format: any text	Specify the Additional Configuration . <i>Value Range:</i> 0 ~ 256 characters.

4G IIoT LoRa Gateway

As an OpenVPN Client

If **Client** is selected, the configuration screen will be changed as below and an OpenVPN Client List screen appear.

Configuration	
Item	Setting
▶ OpenVPN	<input checked="" type="checkbox"/> Enable
▶ Server / Client	Client ▾
▶ OpenVPN Configuration file	<input type="checkbox"/> Enable Upgrade

OpenVPN Configuration		
Item	Value setting	Description
OpenVPN Configuration file	1. An Optional setting. 2. The box is unchecked by default.	Click the Enable box to activate the OpenVPN Client configuration via a pre-defined configuration file. You have to further click the Upgrade button to upload the configuration from a .ovpn file. If you enabled this function, you can't add any OpenVPN clients manually.

OpenVPN Client List														
ID	Client Name	Interface	Protocol	Port	Tunnel Scenario	Remote IP/FQDN	Remote Subnet	Redirect Internet Traffic	NAT	Authorization Mode	Encryption Cipher	Hash Algorithm	Enable	Actions

When **Add** button is applied, OpenVPN Client Configuration screen will appear. **OpenVPN Client Configuration** window let you specify the required parameters for an OpenVPN VPN client, such as "OpenVPN Client Name", "Interface", "Protocol", "Tunnel Scenario", "Remote IP/FQDN", "Remote Subnet", "Authorization Mode", "Encryption Cipher", "Hash Algorithm" and tunnel activation.

OpenVPN Client Configuration	
Item	Setting
▶ OpenVPN Client Name	OpenVPN Client #1
▶ Interface	WAN 1 ▾
▶ Protocol	TCP ▾ Port: 443
▶ Tunnel Scenario	TUN ▾
▶ Remote IP/FQDN	
▶ Remote Subnet	<input type="checkbox"/> Enable <input checkbox"="" type="text" value="255.255.255.0/(24) ▾</td> </tr> <tr> <td>▶ Redirect Internet Traffic</td> <td><input type="/> Enable
▶ NAT	<input checked="" type="checkbox"/> Enable
▶ Authorization Mode	TLS ▾ CA Cert.: ▾ Client Cert.: ▾ Client Key.: ▾ Please set the Certificate.
▶ Encryption Cipher	Blowfish ▾
▶ Hash Algorithm	SHA-1 ▾

4G IIoT LoRa Gateway

▶ LZO Compression	Adaptive ▼
▶ Persist Key	<input checked="" type="checkbox"/> Enable
▶ Persist Tun	<input checked="" type="checkbox"/> Enable
▶ Advanced Configuration	Edit
▶ Tunnel	<input type="checkbox"/> Enable

OpenVPN Client Configuration		
Item	Value setting	Description
OpenVPN Client Name	A Must filled setting	The OpenVPN Client Name will be used to identify the client in the tunnel list. Value Range: 1 ~ 32 characters.
Interface	1. A Must filled setting 2. By default WAN-1 is selected.	Define the physical interface to be used for this OpenVPN Client tunnel.
Protocol	1. A Must filled setting 2. By default TCP is selected.	Define the Protocol for the OpenVPN Client. <ul style="list-style-type: none"> • Select TCP ->The OpenVPN will use TCP protocol, and Port will be set as 443 automatically. • Select UDP -> The OpenVPN will use UDP protocol, and Port will be set as 1194 automatically.
Port	1. A Must filled setting 2. By default 443 is set.	Specify the Port for the OpenVPN Client to use. Value Range: 1 ~ 65535.
Tunnel Scenario	1. A Must filled setting 2. By default TUN is selected.	Specify the type of Tunnel Scenario for the OpenVPN Client to use. It can be TUN for TUN tunnel scenario, or TAP for TAP tunnel scenario.
Remote IP/FQDN	A Must filled setting	Specify the Remote IP/FQDN of the peer OpenVPN Server for this OpenVPN Client tunnel. Fill in the IP address or FQDN.
Remote Subnet	1. An Optional setting. 2. The box is unchecked by default.	Check the Enable box to activate remote subnet function, and specify Remote Subnet of the peer OpenVPN Server for this OpenVPN Client tunnel. Fill in the remote subnet address and remote subnet mask.
Redirect Internet Traffic	1. An Optional setting. 2. The box is unchecked by default.	Check the Enable box to activate the Redirect Internet Traffic function.
NAT	1. An Optional setting. 2. The box is checked by default.	Check the Enable box to activate the NAT function.
Authorization Mode	1. A Must filled setting 2. By default TLS is selected.	Specify the authorization mode for the OpenVPN Server. <ul style="list-style-type: none"> • TLS ->The OpenVPN will use TLS authorization mode, and the following items CA Cert., Client Cert. and Client Key will be displayed. CA Cert. could be selected in Trusted CA Certificate List. Refer to Object Definition > Certificate > Trusted Certificate. Client Cert. could be selected in Local Certificate List. Refer to Object Definition > Certificate > My Certificate. Client Key could be selected in Trusted Client key List. Refer to Object Definition > Certificate > Trusted Certificate. • Static Key ->The OpenVPN will use static key authorization mode, and the following items Local Endpoint IP Address, Remote Endpoint IP Address and Static Key will be displayed.

4G IIoT LoRa Gateway

Local Endpoint IP Address	A Must filled setting	Specify the virtual Local Endpoint IP Address of this OpenVPN gateway. Value Range: The IP format is 10.8.0.x, the range of x is 1~254. Note: Local Endpoint IP Address will be available only when Static Key is chosen in Authorization Mode.
Remote Endpoint IP Address	A Must filled setting	Specify the virtual Remote Endpoint IP Address of the peer OpenVPN gateway. Value Range: The IP format is 10.8.0.x, the range of x is 1~254. Note: Remote Endpoint IP Address will be available only when Static Key is chosen in Authorization Mode.
Static Key	A Must filled setting	Specify the Static Key . Note: Static Key will be available only when Static Key is chosen in Authorization Mode.
Encryption Cipher	By default Blowfish is selected.	Specify the Encryption Cipher . It can be Blowfish/AES-256/AES-192/AES-128/None .
Hash Algorithm	By default SHA-1 is selected.	Specify the Hash Algorithm . It can be SHA-1/MD5/MD4/SHA2-256/SHA2-512/None/Disable .
LZO Compression	By default Adaptive is selected.	Specify the LZO Compression scheme. It can be Adaptive/YES/NO/Default .
Persis Key	1. An Optional setting. 2. The box is checked by default.	Check the Enable box to activate the Persis Key function.
Persis Tun	1. An Optional setting. 2. The box is checked by default.	Check the Enable box to activate the Persis Tun function.
Advanced Configuration	N/A	Click the Edit button to specify the Advanced Configuration setting for the OpenVPN server. If the button is clicked, Advanced Configuration will be displayed below.
Tunnel	The box is unchecked by default	Check the Enable box to activate this OpenVPN tunnel.
Save	N/A	Click Save to save the settings.
Undo	N/A	Click X to cancel the changes and return to last page.

4G IIoT LoRa Gateway

When **Advanced Configuration** is selected, an OpenVPN Client Advanced Configuration screen will appear.

OpenVPN Client Advanced Configuration	
Item	Setting
▶ TLS Cipher	None ▼
▶ TLS Auth. Key(Optional)	<input type="text"/> (Optional)
▶ User Name(Optional)	<input type="text"/> (Optional)
▶ Password(Optional)	<input type="text"/> (Optional)
▶ Bridge TAP to	VLAN 1 ▼
▶ Firewall Protection	<input type="checkbox"/> Enable
▶ Client IP Address	Dynamic IP ▼
▶ Tunnel MTU	1500
▶ Tunnel UDP Fragment	1500
▶ Tunnel UDP MSS-Fix	<input type="checkbox"/> Enable
▶ nsCertType Verification	<input type="checkbox"/> Enable
▶ TLS Renegotiation Time(seconds)	3600 (seconds)
▶ Connection Retry(seconds)	-1 (seconds)
▶ DNS	Automatically ▼
▶ Additional Configuration	<input type="text"/>

OpenVPN Advanced Client Configuration		
Item	Value setting	Description
TLS Cipher	1. A Must filled setting. 2. TLS-RSA-WITH-AES128-SHA is selected by default	Specify the TLS Cipher from the dropdown list. It can be None / TLS-RSA-WITH-RC4-MD5 / TLS-RSA-WITH-AES128-SHA / TLS-RSA-WITH-AES256-SHA / TLS-DHE-DSS-AES128-SHA / TLS-DHE-DSS-AES256-SHA . Note: TLS Cipher will be available only when TLS is chosen in Authorization Mode.
TLS Auth. Key	1. An Optional setting. 2. String format: any text	Specify the TLS Auth. Key for connecting to an OpenVPN server, if the server required it. Note: TLS Auth. Key will be available only when TLS is chosen in Authorization Mode.
User Name	An Optional setting.	Enter the User account for connecting to an OpenVPN server, if the server required it. Note: User Name will be available only when TLS is chosen in Authorization Mode.
Password	An Optional setting.	Enter the Password for connecting to an OpenVPN server, if the server required it. Note: User Name will be available only when TLS is chosen in Authorization Mode.
Bridge TAP to	By default VLAN 1 is selected	Specify the setting of "Bridge TAP to" to bridge the TAP interface to a certain local network interface or VLAN. Note: Bridge TAP to will be available only when TAP is chosen in Tunnel Scenario and NAT is unchecked.
Firewall Protection	The box is unchecked by default.	Check the box to activate the Firewall Protection function. Note: Firewall Protection will be available only when NAT is enabled.

4G IIoT LoRa Gateway

Client IP Address	By default Dynamic IP is selected	Specify the virtual IP Address for the OpenVPN Client. It can be Dynamic IP/Static IP .
Tunnel MTU	1.A Must filled setting 2.The value is 1500 by default	Specify the value of Tunnel MTU . Value Range: 0 ~ 1500.
Tunnel UDP Fragment	The value is 1500 by default	Specify the value of Tunnel UDP Fragment . Value Range: 0 ~ 1500. Note: Tunnel UDP Fragment will be available only when UDP is chosen in Protocol.
Tunnel UDP MSS-Fix	The box is unchecked by default.	Check the Enable box to activate the Tunnel UDP MSS-Fix function. Note: Tunnel UDP MSS-Fix will be available only when UDP is chosen in Protocol.
nsCerType Verification	The box is unchecked by default.	Check the Enable box to activate the nsCerType Verification function. Note: nsCerType Verification will be available only when TLS is chosen in Authorization Mode.
TLS Renegotiation Time (seconds)	The value is 3600 by default	Specify the time interval of TLS Renegotiation Time . Value Range: -1 ~ 86400.
Connection Retry(seconds)	The value is -1 by default	Specify the time interval of Connection Retry . The default -1 means that it is no need to execute connection retry. Value Range: -1 ~ 86400, and -1 means no retry is required.
DNS	By default Automatically is selected	Specify the setting of DNS . It can be Automatically/Manually .
Additional Configuration	An Optional setting.	Enter optional configuration string here. Up to 256 characters is allowable. Value Range: 0 ~ 256characters.
Save	N/A	Click Save to save the settings.
Undo	N/A	Click X to cancel the changes and return to last page.

4G IIoT LoRa Gateway

5.1.3 L2TP

Configuration	
Item	Setting
L2TP	<input type="checkbox"/> Enable
Client/Server	Server ▾

L2TP Server Configuration	
Item	Setting
L2TP Server	<input type="checkbox"/> Enable
Interface	All WANs ▾
L2TP over IPsec	<input type="checkbox"/> Enable Preshared Key <input type="text"/> (Min. 8 characters)
Server Virtual IP	<input type="text" value="192.168.10.1"/>
IP Pool Starting Address	<input type="text" value="10"/>
IP Pool Ending Address	<input type="text" value="17"/>
Authentication Protocol	<input type="checkbox"/> PAP <input type="checkbox"/> CHAP <input type="checkbox"/> MS-CHAP <input type="checkbox"/> MS-CHAP v2
MPPE Encryption	<input type="checkbox"/> Enable <input type="text" value="40 bits"/> ▾
Service Port	<input type="text" value="1701"/>

L2TP Server Status <input type="button" value="Refresh"/>				
User Name	Remote IP	Remote Virtual IP	Remote Call ID	Actions
No connection from remote				

User Account List <input type="button" value="Add"/> <input type="button" value="Delete"/>				
ID	User Name	Password	Enable	Actions

Layer 2 Tunneling Protocol (L2TP) is a tunneling protocol used to support virtual private networks (VPNs) or as part of the delivery of services by ISPs. It does not provide any encryption or confidentiality by itself. Rather, it relies on an encryption protocol that it passes within the tunnel to provide privacy. This Gateway can behave as a L2TP server and a L2TP client both at the same time.

L2TP Server: It must have a static IP or a FQDN for clients to create L2TP tunnels. It also maintains “User Account list” (user name/ password) for client login authentication; There is a virtual IP pool to assign virtual IP to each connected L2TP client.

L2TP Client: It can be mobile users or gateways in remote offices with dynamic IP. To setup tunnel, it should get “user name”, “password” and server’s global IP. In addition, it is required to identify the operation mode for each tunnel as main connection, failover for another tunnel, or load balance tunnel to increase overall bandwidth. It needs to decide “Default Gateway” or “Remote Subnet” for packet flow. Moreover, you can also define what kind of traffics will pass through the L2TP tunnel in the “Default Gateway / Remote Subnet” parameter.

4G IIoT LoRa Gateway

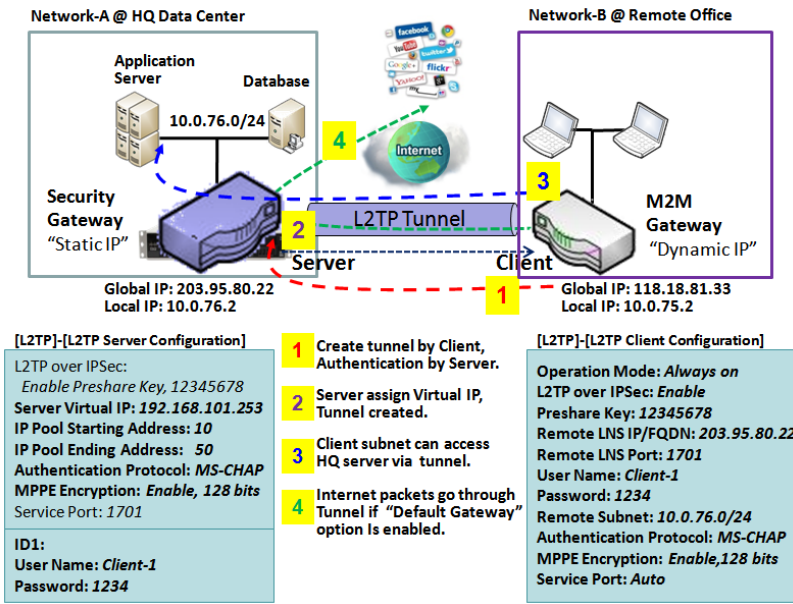

Besides, for the L2TP client peer, a Remote Subnet item is required. It is for the Intranet of L2TP server peer. So, at L2TP client peer, the packets whose destination is in the dedicated subnet will be transferred via the L2TP tunnel. Others will be transferred based on current routing policy of the gateway at L2TP client peer. But, if you entered 0.0.0.0/0 in the Remote Subnet field, it will be treated as a "Default Gateway" setting for the L2TP client peer, all packets, including the Internet accessing of L2TP client peer, will go through the established L2TP tunnel. That means the remote L2TP server peer controls the flow of any packets from the L2TP client peer. Certainly, those packets come through the L2TP tunnel.

4G IIoT LoRa Gateway

L2TP Setting

Go to **Security > VPN > L2TP** tab.

The L2TP setting allows user to create and configure L2TP tunnels.

Enable L2TP

Configuration	
Item	Setting
L2TP	<input type="checkbox"/> Enable
Client/Server	Server ▾

Enable L2TP Window		
Item	Value setting	Description
L2TP	Unchecked by default	Click the Enable box to activate L2TP function.
Client/Server	A Must filled setting	Specify the role of L2TP. Select Server or Client role your gateway will take. Below are the configuration windows for L2TP Server and for L2TP Client.
Save	N/A	Click Save button to save the settings

As a L2TP Server

When select **Server** in Client/Server, the L2TP server Configuration will appear.

L2TP Server Configuration	
Item	Setting
L2TP Server	<input type="checkbox"/> Enable
Interface	WAN1 ▾
L2TP over IPsec	<input type="checkbox"/> Enable Preshared Key <input type="text" value="1234567890"/> (Min. 8 characters)
Server Virtual IP	<input type="text" value="192.168.13.1"/>
IP Pool Starting Address	<input type="text" value="10"/>
IP Pool Ending Address	<input type="text" value="17"/>
Authentication Protocol	<input checked="" type="checkbox"/> PAP <input checked="" type="checkbox"/> CHAP <input type="checkbox"/> MS-CHAP <input type="checkbox"/> MS-CHAP v2
MPPE Encryption	<input type="checkbox"/> Enable <input type="text" value="40 bits"/> ▾
Service Port	<input type="text" value="1701"/>

4G IIoT LoRa Gateway

L2TP Server Configuration		
Item	Value setting	Description
L2TP Server	The box is unchecked by default	When click the Enable box It will active L2TP server
Interface	1. A Must fill setting 2. All WANs is selected by default	Select the interface on which L2TP tunnel is to be established. It can be the available WAN interfaces.
L2TP over IPSec	The box is unchecked by default	When click the Enable box. It will enable L2TP over IPSec and need to fill in the Pre-shared Key (8~32 characters).
Server Virtual IP	A Must filled setting	Specify the L2TP server Virtual IP It will set as this L2TP server local virtual IP
IP Pool Starting Address	1. A Must filled setting 2. 10 is set by default.	Specify the L2TP server starting IP of virtual IP pool It will set as the starting IP which assign to L2TP client Value Range: 1 ~ 254.
IP Pool Ending Address	1. A Must filled setting 2. 17 is set by default.	Specify the L2TP server ending IP of virtual IP pool It will set as the ending IP which assign to L2TP client Value Range: >= Starting Address, and < (Starting Address + 8) or 254.
Authentication Protocol	A Must filled setting	Select single or multiple Authentication Protocols for the L2TP server with which to authenticate L2TP clients. Available authentication protocols are PAP / CHAP / MS-CHAP / MS-CHAP v2 .
MPPE Encryption	A Must filled setting	Specify whether to support MPPE Protocol. Click the Enable box to enable MPPE and from dropdown box to select 40 bits / 56 bits / 128 bits . Note: when MPPE Encryption is enabled, the Authentication Protocol PAP / CHAP options will not be available.
Service Port	A Must filled setting	Specify the Service Port which L2TP server use. Value Range: 1 ~ 65535.
Save	N/A	Click the Save button to save the configuration.
Undo	N/A	Click the Undo button to recovery the configuration.

L2TP Server Status Refresh				
User Name	Remote IP	Remote Virtual IP	Remote Call ID	Actions
No connection from remote				

L2TP Server Status		
Item	Value setting	Description
L2TP Server Status	N/A	It displays the User Name, Remote IP, Remote Virtual IP, and Remote Call ID of the connected L2TP clients. Click the Refresh button to renew the L2TP client information.

4G IIoT LoRa Gateway

User Account List Add Delete				
ID	User Name	Password	Enable	Actions
User Account Configuration Save				
User Name		Password		Account
<input type="text"/>		<input type="text"/>		<input type="checkbox"/> Enable
Save				

User Account List Window		
Item	Value setting	Description
User Account List	Max.of 10 user accounts	<p>This is the L2TP authentication user account entry. You can create and add accounts for remote clients to establish L2TP VPN connection to the gateway device.</p> <p>Click Add button to add user account. Enter User name and password. Then check the enable box to enable the user.</p> <p>Click Save button to save new user account.</p> <p>The selected user account can permanently be deleted by clicking the Delete button.</p> <p><u>Value Range:</u> 1 ~ 32 characters.</p>

4G IIoT LoRa Gateway

As a L2TP Client

When select Client in Client/Server, a series L2TP Client Configuration will appear.

L2TP Client Configuration	
Item	Setting
L2TP Client	<input type="checkbox"/> Enable

Item Setting	Value setting	Description
L2TP Client	The box is unchecked by default	Check the Enable box to enable L2TP client role of the gateway.
Save	N/A	Click Save button to save the settings.
Undo	N/A	Click Undo button to cancel the settings.

Create/Edit L2TP Client

L2TP Client List & Status								
ID	Tunnel Name	Interface	Virtual IP	Remote IP/FQDN	Remote Subnet	Status	Enable	Actions
1	L2TP #1	WAN 1	0.0.0.0	192.168.127.72			<input type="checkbox"/>	<input type="button" value="Edit"/> <input type="checkbox"/> Select

When **Add/Edit** button is applied, a series of configuration screen will appear. You can add up to 8 L2TP Clients.

L2TP Client Configuration	
Item	Setting
Tunnel Name	<input type="text" value="L2TP #1"/>
Interface	<input type="text" value="WAN1"/>
L2TP over IPsec	<input type="checkbox"/> Enable Preshared Key <input type="text" value=""/> (Min. 8 characters)
Remote LNS IP/FQDN	<input type="text"/>
MTU	<input type="text" value="1500"/>
Remote LNS Port	<input type="text" value="1701"/>
User Name	<input type="text"/>
Password	<input type="text"/>
Tunneling Password (Optional)	<input type="text"/>
Remote Subnet	<input type="text"/>
Authentication Protocol	<input type="checkbox"/> PAP <input type="checkbox"/> CHAP <input type="checkbox"/> MS-CHAP <input type="checkbox"/> MS-CHAP v2

4G IIoT LoRa Gateway

▶ MPPE Encryption	<input type="checkbox"/> Enable
▶ NAT before Tunneling	<input type="checkbox"/> Enable
▶ LCP Echo Type	Auto Interval <input type="text" value="30"/> seconds Max. Failure Time <input type="text" value="6"/> times
▶ Service Port	Auto <input type="text" value="0"/>
▶ Tunnel	<input type="checkbox"/> Enable

L2TP Client Configuration		
Item Setting	Value setting	Description
Tunnel Name	A Must filled setting	Enter a tunnel name. Enter a name that is easy for you to identify. Value Range: 1 ~ 32 characters.
Interface	A Must filled setting	Define the selected interface to be the used for this L2TP tunnel (WAN-1 is available only when WAN-1 interface is enabled) The same applies to other WAN interfaces (e.g. WAN-2).
L2TP over IPSec	The box is unchecked by default	Check the Enable box to activate L2TP over IPSec, and further specify a Pre-shared Key (8~32 characters).
Remote LNS IP/FQDN	A Must filled setting	Enter the public IP address or the FQDN of the L2TP server.
MTU	1.A Must filled setting 2.The value is 1500 by default	Specify the MTU . Value Range: 0 ~ 1500.
Remote LNS Port	1. A Must filled setting 2. 1701 is set by default	Enter the Remote LNS Port for this L2TP tunnel. Value Range: 1 ~ 65535.
User Name	A Must filled setting	Enter the User Name for this L2TP tunnel to be authenticated when connect to L2TP server. Value Range: 1 ~ 32 characters.
Password	A Must filled setting	Enter the Password for this L2TP tunnel to be authenticated when connect to L2TP server.
Tunneling Password(Optional)	An Optional filled setting	Enter the Tunneling Password for this L2TP tunnel to authenticate.
Remote Subnet	A Must filled setting	Specify the remote subnet for this L2TP tunnel to reach L2TP server. The Remote Subnet format must be IP address/netmask (e.g. 10.0.0.2/24). It is for the Intranet of L2TP VPN server. So, at L2TP client peer, the packets whose destination is in the dedicated subnet will be transferred via the L2TP VPN tunnel. Others will be transferred based on current routing policy of the security gateway at L2TP client peer. If you entered 0.0.0.0/0 in the Remote Subnet field, it will be treated as a default gateway setting for the L2TP client peer, all packets, including the Internet accessing of L2TP Client peer, will go through the established L2TP VPN tunnel. That means the remote L2TP VPN server controls the flow of any packets from the L2TP client peer. Certainly, those packets come through the L2TP VPN tunnel.
Authentication Protocol	1. A Must filled setting 2. Unchecked by	Specify one ore multiple Authentication Protocol for this L2TP tunnel. Available authentication methods are PAP / CHAP / MS-CHAP / MS-CHAP v2 .

4G IIoT LoRa Gateway

	default	
MPPE Encryption	<ol style="list-style-type: none"> 1. Unchecked by default 2. an optional setting 	<p>Specify whether L2TP server supports MPPE Protocol. Click the Enable box to enable MPPE.</p> <p>Note: when MPPE Encryption is enabled, the Authentication Protocol PAP / CHAP options will not be available.</p>
NAT before Tunneling	<ol style="list-style-type: none"> 1. A Must filled setting 2. Unchecked by default 	Specify whether NAT is required or not for this L2TP tunnel.
LCP Echo Type	<ol style="list-style-type: none"> 1. Auto is set by default 	<p>Specify the LCP Echo Type for this L2TP tunnel. It can be Auto, User-defined, or Disable.</p> <p>Auto: the system sets the Interval and Max. Failure Time.</p> <p>User-defined: enter the Interval and Max. Failure Time. The default value for Interval is 30 seconds, and Maximum Failure Times is 6 Times.</p> <p>Disable: disable the LCP Echo.</p> <p>Value Range: 1 ~ 99999 for Interval Time, 1~999 for Failure Time.</p>
Service Port	A Must filled setting	<p>Specify the Service Port for this L2TP tunnel to use. It can be Auto, (1701) for Cisco, or User-defined.</p> <p>Auto: The system determines the service port.</p> <p>1701 (for Cisco): The system use port 1701 for connecting with CISCO L2TP Server.</p> <p>User-defined: Enter the service port. The default value is 0.</p> <p>Value Range: 0 ~ 65535.</p>
Tunnel	Unchecked by default	Check the Enable box to enable this L2TP tunnel.
Save	N/A	Click Save button to save the settings.
Undo	N/A	Click X button to cancel the settings and back to last page.

4G IIoT LoRa Gateway

5.1.4 PPTP

The screenshot displays a web-based configuration interface for PPTP. It is organized into four main sections:

- Configuration:** A table with two columns: 'Item' and 'Setting'. It shows 'PPTP' with an 'Enable' checkbox and 'Client/Server' set to 'Server'.
- PPTP Server Configuration:** A table with two columns: 'Item' and 'Setting'. It includes settings for 'PPTP Server' (Enable), 'Interface' (All WANs), 'Server Virtual IP' (192.168.0.1), 'IP Pool Starting Address' (10), 'IP Pool Ending Address' (17), 'Authentication Protocol' (PAP, CHAP, MS-CHAP, MS-CHAP v2), and 'MPPE Encryption' (Enable, 40 bits).
- PPTP Server Status:** A table with columns: 'User Name', 'Remote IP', 'Remote Virtual IP', 'Remote Call ID', and 'Actions'. It shows 'No connection from remote' and a 'Refresh' button.
- User Account List:** A table with columns: 'ID', 'User Name', 'Password', 'Enable', and 'Actions'. It includes 'Add' and 'Delete' buttons.

Point-to-Point Tunneling Protocol (PPTP) is a method for implementing virtual private networks. PPTP uses a control channel over TCP and a GRE tunnel operating to encapsulate PPP packets. It is a client-server based technology. There are various levels of authentication and encryption for PPTP tunneling, usually natively as standard features of the Windows PPTP stack. The security gateway can play either "PPTP Server" role or "PPTP Client" role for a PPTP VPN tunnel, or both at the same time for different tunnels. PPTP tunnel process is nearly the same as L2TP.

PPTP Server: It must have a static IP or a FQDN for clients to create PPTP tunnels. It also maintains "User Account list" (user name / password) for client login authentication; There is a virtual IP pool to assign virtual IP to each connected PPTP client. u

PPTP Client: It can be mobile users or gateways in remote offices with dynamic IP. To setup tunnel, it should get "user name", "password" and server's global IP. In addition, it is required to identify the operation mode for each tunnel as main connection, failover for another tunnel, or load balance tunnel to increase overall bandwidth. It needs to decide "Default Gateway" or "Remote Subnet" for packet flow. Moreover, you can also define what kind of traffics will pass through the PPTP tunnel in the "Default Gateway / Remote Subnet" parameter.

4G IIoT LoRa Gateway

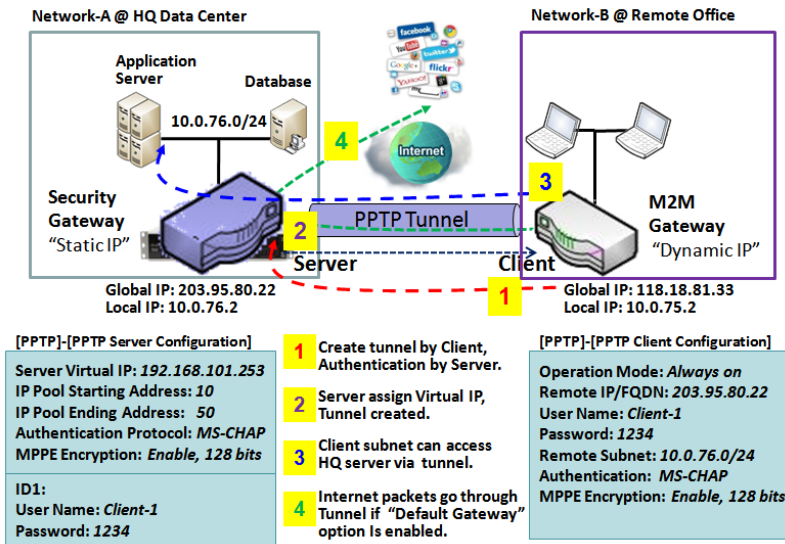

Besides, for the PPTP client peer, a Remote Subnet item is required. It is for the Intranet of PPTP server peer. So, at PPTP client peer, the packets whose destination is in the dedicated subnet will be transferred via the PPTP tunnel. Others will be transferred based on current routing policy of the gateway at PPTP client peer. But, if you entered 0.0.0.0/0 in the Remote Subnet field, it will be treated as a "Default Gateway" setting for the PPTP client peer, all packets, including the Internet accessing of PPTP client peer, will go through the established PPTP tunnel. That means the remote PPTP server peer controls the flow of any packets from the PPTP client peer.

Certainly, those packets come through the PPTP tunnel.

4G IIoT LoRa Gateway

PPTP Setting

Go to **Security > VPN > PPTP** tab.

The PPTP setting allows user to create and configure PPTP tunnels.

Enable PPTP

Configuration	
Item	Setting
PPTP	<input type="checkbox"/> Enable
Client/Server	Server ▾

Enable PPTP Window		
Item	Value setting	Description
PPTP	Unchecked by default	Click the Enable box to activate PPTP function.
Client/Server	A Must fill setting	Specify the role of PPTP. Select Server or Client role your gateway will take. Below are the configuration windows for PPTP Server and for Client.
Save	N/A	Click Save button to save the settings.

As a PPTP Server

The gateway supports up to a maximum of 10 PPTP user accounts.

When **Server** in the Client/Server field is selected, the PPTP server configuration window will appear.

PPTP Server Configuration	
Item	Setting
PPTP Server	<input type="checkbox"/> Enable
Interface	WAN1 ▾
Server Virtual IP	192.168.12.1
IP Pool Starting Address	10
IP Pool Ending Address	17
Authentication Protocol	<input type="checkbox"/> PAP <input type="checkbox"/> CHAP <input checked="" type="checkbox"/> MS-CHAP <input checked="" type="checkbox"/> MS-CHAP v2
MPPE Encryption	<input checked="" type="checkbox"/> Enable 40 bits ▾

4G IIoT LoRa Gateway

PPTP Server Configuration Window		
Item	Value setting	Description
PPTP Server	Unchecked by default	Check the Enable box to enable PPTP server role of the gateway.
Interface	1. A Must fill setting 2. All WANs is selected by default	Select the interface on which PPTP tunnel is to be established. It can be the available WAN interfaces.
Server Virtual IP	1. A Must fill setting 2. Default is 192.168.0.1	Specify the PPTP server Virtual IP address. The virtual IP address will serve as the virtual DHCP server for the PPTP clients. Clients will be assigned a virtual IP address from it after the PPTP tunnel has been established.
IP Pool Starting Address	1. A Must fill setting 2. Default is 10	This is the PPTP server's Virtual IP DHCP server. User can specify the first IP address for the subnet from which the PPTP client's IP address will be assigned. Value Range: 1 ~ 254.
IP Pool Ending Address	1. A Must fill setting 2. Default is 17	This is the PPTP server's Virtual IP DHCP server. User can specify the last IP address for the subnet from which the PPTP client's IP address will be assigned. Value Range: >= Starting Address, and < (Starting Address + 8) or 254.
Authentication Protocol	1. A Must fill setting 2. Unchecked by default	Select single or multiple Authentication Protocols for the PPTP server with which to authenticate PPTP clients. Available authentication protocols are PAP / CHAP / MS-CHAP / MS-CHAP v2.
MPPE Encryption	1. A Must fill setting 2. Unchecked by default	Specify whether to support MPPE Protocol. Click the Enable box to enable MPPE and from dropdown box to select 40 bits / 56 bits / 128 bits. Note: when MPPE Encryption is enabled, the Authentication Protocol PAP / CHAP options will not be available.
Save	N/A	Click Save button to save the settings.
Undo	N/A	Click Undo button to cancel the settings.

PPTP Server Status Refresh				
User Name	Remote IP	Remote Virtual IP	Remote Call ID	Actions
No connection from remote				

PPTP Server Status Window		
Item	Value setting	Description
PPTP Server Status	N/A	It displays the User Name, Remote IP, Remote Virtual IP, and Remote Call ID of the connected PPTP clients. Click the Refresh button to renew the PPTP client information.

User Account List Add Delete				
ID	User Name	Password	Enable	Actions

User Account Configuration Save		
User Name	Password	Account
<input type="text"/>	<input type="text"/>	<input type="checkbox"/> Enable

User Account List Window		
Item	Value setting	Description

4G IIoT LoRa Gateway

User Account List	Max.of 10 user accounts	<p>This is the PPTP authentication user account entry. You can create and add accounts for remote clients to establish PPTP VPN connection to the gateway device.</p> <p>Click Add button to add user account. Enter User name and password. Then check the enable box to enable the user.</p> <p>Click Save button to save new user account.</p> <p>The selected user account can permanently be deleted by clicking the Delete button.</p> <p><u>Value Range:</u> 1 ~ 32 characters.</p>
--------------------------	-------------------------	---

As a PPTP Client

When select Client in Client/Server, a series PPTP Client Configuration will appear.

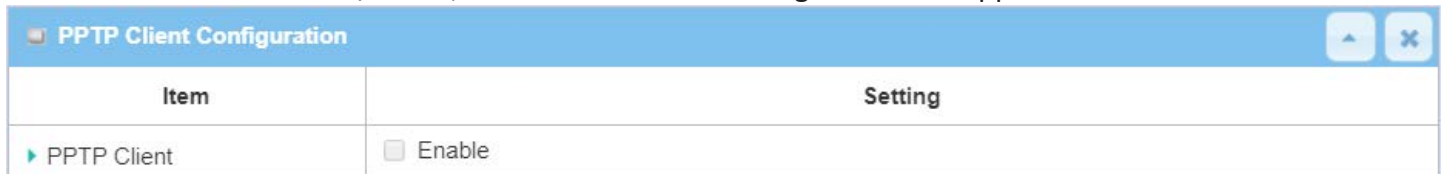

The screenshot shows a window titled "PPTP Client Configuration" with a blue header and a close button. Below the header is a table with two columns: "Item" and "Setting".

Item	Setting
PPTP Client	<input type="checkbox"/> Enable

PPTP Client Configuration		
Item	Value setting	Description
PPTP Client	Unchecked by default	Check the Enable box to enable PPTP client role of the gateway.
Save	N/A	Click Save button to save the settings.
Undo	N/A	Click Undo button to cancel the settings.

Create/Edit PPTP Client



The screenshot shows a window titled "PPTP Client List & Status" with a blue header containing "Add", "Delete", and "Refresh" buttons, and a close button. Below the header is a table with the following columns: ID, Tunnel Name, Interface, Virtual IP, Remote IP/FQDN, Remote Subnet, Status, Enable, and Actions.

ID	Tunnel Name	Interface	Virtual IP	Remote IP/FQDN	Remote Subnet	Status	Enable	Actions
----	-------------	-----------	------------	----------------	---------------	--------	--------	---------

When **Add/Edit** button is applied, a series PPTP Client Configuration will appear.

4G IIoT LoRa Gateway

PPTP Client Configuration	
Item	Setting
▶ Tunnel Name	<input type="text" value="PPTP #1"/>
▶ Interface	<input type="text" value="WAN1"/>
▶ Remote IP/FQDN	<input type="text"/>
▶ MTU	<input type="text" value="1500"/>
▶ User Name	<input type="text"/>
▶ Password	<input type="text"/>
▶ Remote Subnet	<input type="text"/>
▶ Authentication Protocol	<input type="checkbox"/> PAP <input type="checkbox"/> CHAP <input type="checkbox"/> MS-CHAP <input type="checkbox"/> MS-CHAP v2
▶ MPPE Encryption	<input type="checkbox"/> Enable
▶ NAT before Tunneling	<input type="checkbox"/> Enable
▶ LCP Echo Type	<input type="text" value="Auto"/>
▶ Tunnel	<input type="checkbox"/> Enable
	Interval <input type="text" value="30"/> seconds Max. Failure Time <input type="text" value="6"/> times

PPTP Client Configuration Window		
Item	Value setting	Description
Tunnel Name	A Must fill setting	Enter a tunnel name. Enter a name that is easy for you to identify. Value Range: 1 ~ 32 characters.
Interface	1. A Must fill setting 2. WAN1 is selected by default	Define the selected interface to be the used for this PPTP tunnel (WAN-1 is available only when WAN-1 interface is enabled) The same applies to other WAN interfaces (e.g. WAN-2).
Remote IP/FQDN	1. A Must fill setting. 2. Format can be a ipv4 address or FQDN	Enter the public IP address or the FQDN of the PPTP server.
MTU	1.A Must filled setting 2.The value is 1500 by default	Specify the MTU . Value Range: 0 ~ 1500.
User Name	A Must fill setting	Enter the User Name for this PPTP tunnel to be authenticated when connect to PPTP server. Value Range: 1 ~ 32 characters.
Password	A Must fill setting	Enter the Password for this PPTP tunnel to be authenticated when connect to PPTP server.
Remote Subnet	A Must fill setting	Specify the remote subnet for this PPTP tunnel to reach PPTP server. The Remote Subnet format must be IP address/netmask (e.g. 10.0.0.2/24). It is for the Intranet of PPTP VPN server. So, at PPTP client peer, the packets whose destination is in the dedicated subnet will be transferred via the PPTP VPN tunnel. Others will be transferred based on current routing policy of the security gateway at PPTP client peer. If you entered 0.0.0.0/0 in the Remote Subnet field, it will be treated as a default gateway setting for the PPTP client peer, all packets, including the Internet accessing of PPTP Client peer, will go through the established PPTP VPN tunnel. That means the remote PPTP VPN server controls the flow of any

4G IIoT LoRa Gateway

		packets from the PPTP client peer. Certainly, those packets come through the PPTP VPN tunnel.
Authentication Protocol	<ol style="list-style-type: none"> 1. A Must fill setting 2. Unchecked by default 	Specify one ore multiple Authentication Protocol for this PPTP tunnel. Available authentication methods are PAP / CHAP / MS-CHAP / MS-CHAP v2 .
MPPE Encryption	<ol style="list-style-type: none"> 1. Unchecked by default 2. an optional setting 	Specify whether PPTP server supports MPPE Protocol . Click the Enable box to enable MPPE. Note: when MPPE Encryption is enabled, the Authentication Protocol PAP / CHAP options will not be available.
NAT before Tunneling	<ol style="list-style-type: none"> 1. A Must filled setting 2. Unchecked by default 	Specify whether NAT is required or not for this PPTP tunnel.
LCP Echo Type	Auto is set by default	Specify the LCP Echo Type for this PPTP tunnel. It can be Auto , User-defined , or Disable . Auto : the system sets the Interval and Max. Failure Time. User-defined : enter the Interval and Max. Failure Time. The default value for Interval is 30 seconds, and Maximum Failure Times is 6 Times. Disable : disable the LCP Echo. Value Range : 1 ~ 99999 for Interval Time, 1~999 for Failure Time.
Tunnel	Unchecked by default	Check the Enable box to enable this PPTP tunnel.
Save	N/A	Click Save button to save the settings.
Undo	N/A	Click X button to cancel the settings and back to last page.

4G IIoT LoRa Gateway

5.1.5 GRE

Configuration	
Item	Setting
GRE Tunnel	<input type="checkbox"/> Enable
Max. Concurrent GRE Tunnels	32

GRE Tunnel List										
ID	Tunnel Name	Interface	Tunnel IP	Remote IP	MTU	Key	TTL	Remote Subnet	Enable	Actions

Generic Routing Encapsulation (GRE) is a tunneling protocol developed by Cisco Systems that encapsulates a wide variety of network layer protocols inside virtual point-to-point links over an Internet Protocol internetwork.

Deploy a M2M gateway for remote site and establish a virtual private network with control center by using GRE tunneling. So, all client hosts behind M2M gateway can make data communication with server hosts behind control center gateway.

GRE Tunneling is similar to IPsec Tunneling, client requesting the tunnel establishment with the server. Both the client and the server must have a Static IP or a FQDN. Any peer gateway can be worked as either a client or a server, even using the same set of configuration rule.

GRE Tunnel Scenario

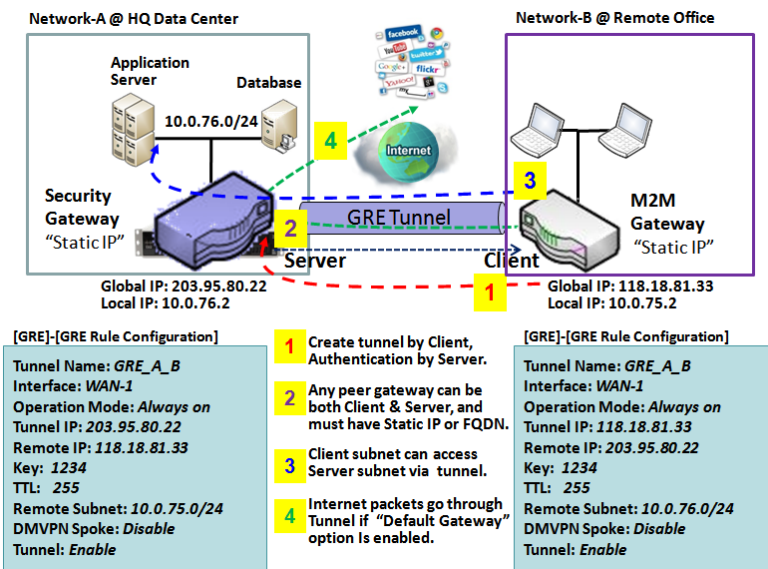

To setup a GRE tunnel, each peer needs to setup its global IP as tunnel IP and fill in the other's global IP as remote IP.

Besides, each peer must further specify the Remote Subnet item. It is for the Intranet of GRE server peer. So, at GRE client peer, the packets whose destination is in the dedicated subnet will be transferred via the GRE tunnel. Others will be transferred based on current routing policy of the gateway at GRE client peer. But, if you entered 0.0.0.0/0 in the Remote Subnet field, it will be treated as a "Default Gateway" setting for the GRE client peer, all packets, including the Internet accessing of GRE client peer, will go through the established GRE

tunnel. That means the remote GRE server peer controls the flow of any packets from the GRE client peer. Certainly, those packets come through the GRE tunnel.

If the GRE server supports DMVPN Hub function, like Cisco router as the VPN concentrator, the GRE client can active the DMVPN spoke function here since it is implemented by GRE over IPsec tunneling.

4G IIoT LoRa Gateway

GRE Setting

Go to **Security > VPN > GRE** tab.

The GRE setting allows user to create and configure GRE tunnels.

Enable GRE

Configuration	
Item	Setting
GRE Tunnel	<input type="checkbox"/> Enable
Max. Concurrent GRE Tunnels	32

Enable GRE Window		
Item	Value setting	Description
GRE Tunnel	Unchecked by default	Click the Enable box to enable GRE function.
Max. Concurrent GRE Tunnels	Depends on Product specification.	The specified value will limit the maximum number of simultaneous GRE tunnel connection. The default value can be different for the purchased model.
Save	N/A	Click Save button to save the settings
Undo	N/A	Click Undo button to cancel the settings

Create/Edit GRE tunnel

GRE Tunnel List										
ID	Tunnel Name	Interface	Tunnel IP	Remote IP	MTU	Key	TTL	Remote Subnet	Enable	Actions

When **Add/Edit** button is applied, a GRE Rule Configuration screen will appear.

4G IIoT LoRa Gateway

GRE Rule Configuration	
Item	Setting
▶ Tunnel Name	<input type="text" value="GRE #1"/>
▶ Interface	<input type="text" value="WAN1"/>
▶ Tunnel IP	IP: <input type="text"/> MASK: <input type="text" value="-- select one --"/> (Optional)
▶ Remote IP	<input type="text"/>
▶ MTU	<input type="text"/>
▶ Key	<input type="text"/> (Optional)
▶ TTL	<input type="text"/>
▶ Remote Subnet	<input type="text"/>
▶ Tunnel	<input type="checkbox"/> Enable

GRE Rule Configuration Window		
Item	Value setting	Description
Tunnel Name	A Must fill setting	Enter a tunnel name. Enter a name that is easy for you to identify. Value Range: 1 ~ 9 characters.
Interface	1. A Must fill setting 2. WAN 1 is selected by default	Select the interface on which GRE tunnel is to be established. It can be the available WAN and LAN interfaces.
Tunnel IP	An Optional setting	Enter the Tunnel IP address and corresponding subnet mask.
Remote IP	A Must fill setting	Enter the Remote IP address of remote GRE tunnel gateway. Normally this is the public IP address of the remote GRE gateway.
MTU	1. A Must filled setting 2. Auto (value zero or blank) is set by default	MTU refers to Maximum Transmission Unit. It specifies the largest packet size permitted for Internet transmission. When set to Auto (value '0' or blank), the router selects the best MTU for best Internet connection performance. Value Range: 0 ~ 1500.
Key	An Optional setting	Enter the Key for the GRE connection. Value Range: 0 ~ 9999999999.
TTL	1. A Must fill setting 2. 1 to 255 range	Specify TTL hop-count value for this GRE tunnel. Value Range: 1 ~ 255.
Remote Subnet	A Must fill setting	Specify the remote subnet for this GRE tunnel. The Remote Subnet format must be IP address/netmask (e.g. 10.0.0.2/24). It is for the Intranet of GRE server peer. So, at GRE client peer, the packets whose destination is in the dedicated subnet will be transferred via the GRE tunnel. Others will be transferred based on current routing policy of the security gateway at GRE client peer. If you entered 0.0.0.0/0 in the Remote Subnet field, it will be treated as a default gateway setting for the GRE client peer, all packets, including the

4G IIoT LoRa Gateway

		Internet accessing of GRE client peer, will go through the established GRE tunnel. That means the remote GRE server peer controls the flow of any packets from the GRE client peer. Certainly, those packets come through the GRE tunnel.
Tunnel	Unchecked by default	Check Enable box to enable this GRE tunnel.
Save	N/A	Click Save button to save the settings.
Undo	N/A	Click X button to cancel the settings and back to last page.

4G IIoT LoRa Gateway

5.2 Firewall

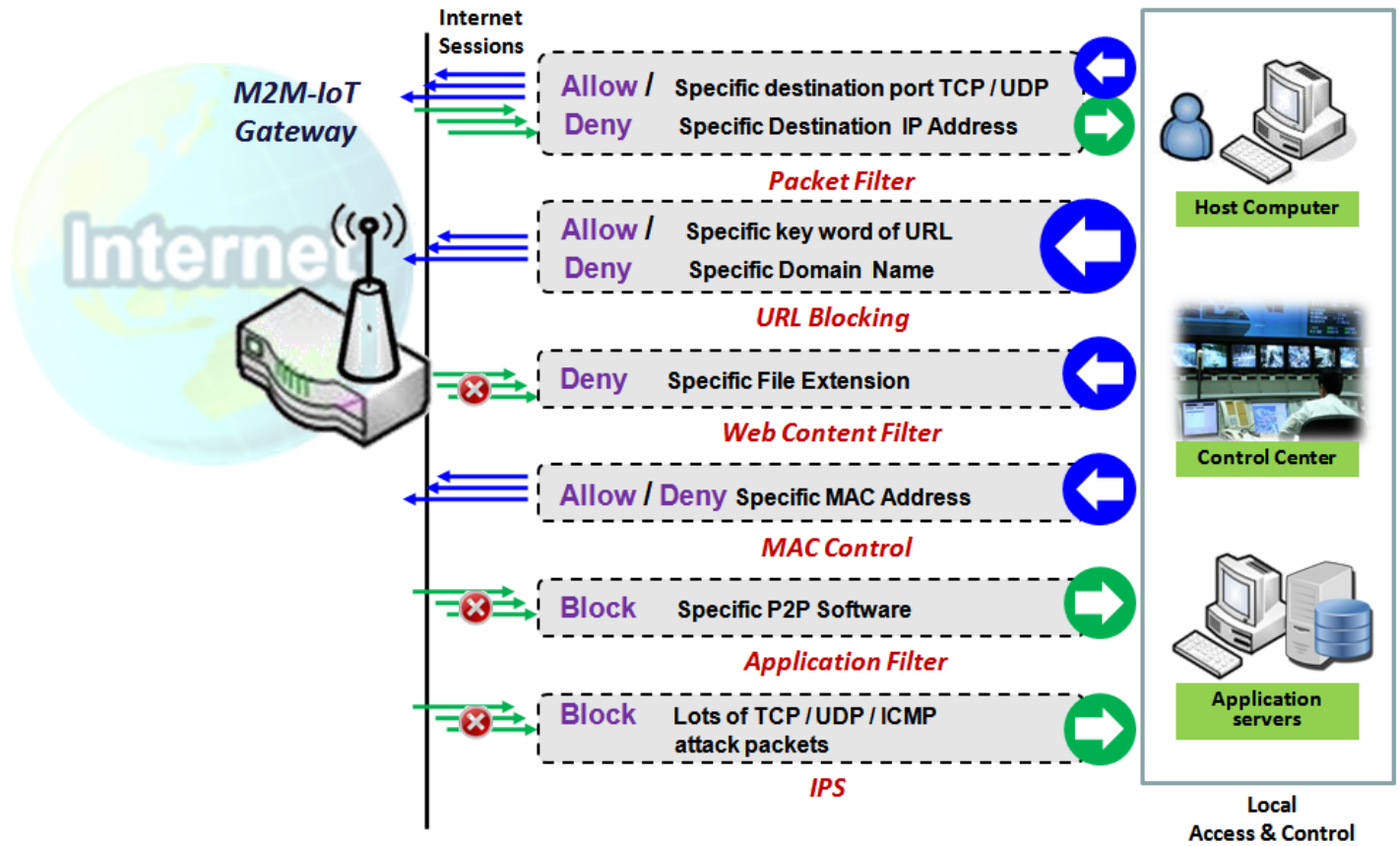

The firewall functions include Packet Filter, URL Blocking, Content Filter, MAC Control, Application Filter, IPS and some firewall options. The supported function can be different for the purchased gateway.

5.2.1 Packet Filter

Configuration												
Item	Setting											
▶ Packet Filters	<input checked="" type="checkbox"/> Enable											
▶ Black List / White List	Deny those match the following rules. ▼											
▶ Log Alert	<input type="checkbox"/> Log Alert											
Packet Filter List												
Add Delete												
ID	Rule Name	From Interface	To Interface	Source IP	Destination IP	Source MAC	Protocol	Source Port	Destination Port	Time Schedule	Enable	Actions

4G IIoT LoRa Gateway

"Packet Filter" function can let you define some filtering rules for incoming and outgoing packets. So the gateway can control what packets are allowed or blocked to pass through it. A packet filter rule should indicate from and to which interface the packet enters and leaves the gateway, the source and destination IP addresses, and destination service port type and port number. In addition, the time schedule to which the rule will be active.

Packet Filter with White List Scenario

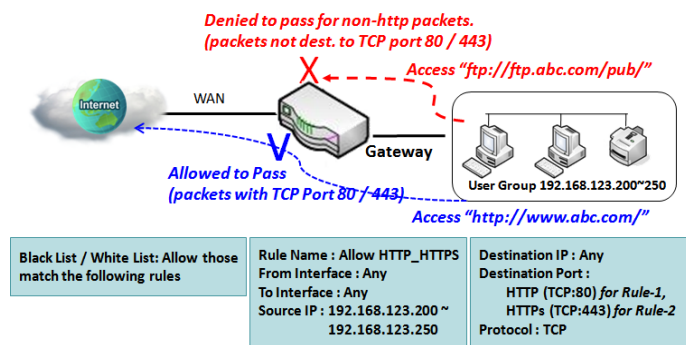

As shown in the diagram, specify "Packet Filter Rule List" as white list (Allow those match the following rules) and define the rules. Rule-1 is to allow HTTP packets to pass, and Rule-2 is to allow HTTPS packets to pass.

Under such configuration, the gateway will allow only HTTP and HTTPS packets, issued from the IP range 192.168.123.200 to 250, which are targeted to TCP port 80 or 443 to pass the WAN interface.

Packet Filter Setting

Go to **Security > Firewall > Packet Filter** Tab.

The packet filter setting allows user to create and customize packet filter policies to allow or reject specific inbound/outbound packets through the router based on their office setting.

Enable Packet Filter

Item	Setting
▶ Packet Filters	<input type="checkbox"/> Enable
▶ Black List / White List	Deny those match the following rules. ▼
▶ Log Alert	<input type="checkbox"/> Log Alert

Item Name	Value setting	Description
Packet Filter	The box is unchecked by default	Check the Enable box to activate Packet Filter function

4G IIoT LoRa Gateway

Black List / White List	Deny those match the following rules is set by default	When Deny those match the following rules is selected, as the name suggest, packets specified in the rules will be blocked –black listed. In contrast, with Allow those match the following rules , you can specifically white list the packets to pass and the rest will be blocked.
Log Alert	The box is unchecked by default	Check the Enable box to activate Event Log.
Save	N/A	Click Save to save the settings
Undo	N/A	Click Undo to cancel the settings

Create/Edit Packet Filter Rules

The gateway allows you to customize your packet filtering rules. It supports up to a maximum of 20 filter rule sets.

ID	Rule Name	From Interface	To Interface	Source IP	Destination IP	Source MAC	Protocol	Source Port	Destination Port	Time Schedule	Enable	Actions
----	-----------	----------------	--------------	-----------	----------------	------------	----------	-------------	------------------	---------------	--------	---------

When **Add** button is applied, **Packet Filter Rule Configuration** screen will appear.

Item	Setting
▶ Rule Name	Rule1
▶ From Interface	Any ▼
▶ To Interface	Any ▼
▶ Source IP	Any ▼
▶ Destination IP	Any ▼
▶ Source MAC	Any ▼
▶ Protocol	Any(0) ▼
▶ Source Port	User-defined Service ▼ [] - []
▶ Destination Port	User-defined Service ▼ [] - []
▶ Time Schedule	(0) Always ▼
▶ Rule	<input type="checkbox"/> Enable

Item Name	Value setting	Description
Rule Name	1. String format can be any text 2. A Must filled setting	Enter a packet filter rule name. Enter a name that is easy for you to remember. Value Range: 1 ~ 30 characters.
From Interface	1. A Must filled setting	Define the selected interface to be the packet-entering interface of the router.

4G IIoT LoRa Gateway

	<p>2. By default Any is selected</p> <p>If the packets to be filtered are coming from LAN to WAN then select LAN for this field. Or VLAN-1 to WAN then select VLAN-1 for this field. Other examples are VLAN-1 to VLAN-2. VLAN-1 to WAN.</p> <p>Select Any to filter packets coming into the router from any interfaces.</p> <p>Please note that two identical interfaces are not accepted by the router. e.g., VLAN-1 to VLAN-1.</p>
<p>To Interface</p> <p>1. A Must filled setting 2. By default Any is selected</p>	<p>Define the selected interface to be the packet-leaving interface of the router. If the packets to be filtered are entering from LAN to WAN then select WAN for this field. Or VLAN-1 to WAN then select WAN for this field. Other examples are VLAN-1 to VLAN-2. VLAN-1 to WAN.</p> <p>Select Any to filter packets leaving the router from any interfaces.</p> <p>Please note that two identical interfaces are not accepted by the router. e.g., VLAN-1 to VLAN-1.</p>
<p>Source IP</p> <p>1. A Must filled setting 2. By default Any is selected</p>	<p>This field is to specify the Source IP address.</p> <p>Select Any to filter packets coming from any IP addresses.</p> <p>Select Specific IP Address to filter packets coming from an IP address.</p> <p>Select IP Range to filter packets coming from a specified range of IP address.</p> <p>Select IP Address-based Group to filter packets coming from a pre-defined group. Note: group must be pre-defined before this option become available. Refer to Object Definition > Grouping > Host grouping. You may also access to create a group by the Add Rule shortcut button.</p>
<p>Destination IP</p> <p>1. A Must filled setting 2. By default Any is selected</p>	<p>This field is to specify the Destination IP address.</p> <p>Select Any to filter packets that are entering to any IP addresses.</p> <p>Select Specific IP Address to filter packets entering to an IP address entered in this field.</p> <p>Select IP Range to filter packets entering to a specified range of IP address entered in this field.</p> <p>Select IP Address-based Group to filter packets entering to a pre-defined group selected. Note: group must be pre-defined before this selection become available. Refer to Object Definition > Grouping > Host grouping. You may also access to create a group by the Add Rule shortcut button. Setting done through the Add Rule button will also appear in the Host grouping setting screen.</p>
<p>Source MAC</p> <p>1. A Must filled setting 2. By default Any is selected</p>	<p>This field is to specify the Source MAC address.</p> <p>Select Any to filter packets coming from any MAC addresses.</p> <p>Select Specific MAC Address to filter packets coming from a MAC address.</p> <p>Select MAC Address-based Group to filter packets coming from a pre-defined group selected. Note: group must be pre-defined before this selection become available. Refer to Object Definition > Grouping > Host grouping. You may also access to create a group by the Add Rule shortcut button.</p>
<p>Protocol</p> <p>1. A Must filled setting 2. By default Any(0) is selected</p>	<p>For Protocol, select Any to filter any protocol packets</p> <p>Then for Source Port, select a predefined port dropdown box when Well-known Service is selected, otherwise select User-defined Service and specify a port range.</p> <p>Then for Destination Port, select a predefined port dropdown box when Well-known Service is selected, otherwise select User-defined Service and specify a port range.</p>

4G IIoT LoRa Gateway

		<p><u>Value Range:</u> 1 ~ 65535 for Source Port, Destination Port.</p> <p>For Protocol, select ICMPv4 to filter ICMPv4 packets</p> <p>For Protocol, select TCP to filter TCP packets</p> <p>Then for Source Port, select a predefined port dropdown box when Well-known Service is selected, otherwise select User-defined Service and specify a port range.</p> <p>Then for Destination Port, select a predefined port dropdown box when Well-known Service is selected, otherwise select User-defined Service and specify a port range.</p> <p><u>Value Range:</u> 1 ~ 65535 for Source Port, Destination Port.</p> <p>For Protocol, select UDP to filter UDP packets</p> <p>Then for Source Port, select a predefined port dropdown box when Well-known Service is selected, otherwise select User-defined Service and specify a port range.</p> <p>Then for Destination Port, select a predefined port dropdown box when Well-known Service is selected, otherwise select User-defined Service and specify a port range.</p> <p><u>Value Range:</u> 1 ~ 65535 for Source Port, Destination Port.</p> <p>For Protocol, select GRE to filter GRE packets</p> <p>For Protocol, select ESP to filter ESP packets</p> <p>For Protocol, select SCTP to filter SCTP packets</p> <p>For Protocol, select User-defined to filter packets with specified port number. Then enter a port number in Protocol Number box.</p>
Time Schedule	A Must filled setting	Apply Time Schedule to this rule, otherwise leave it as Always. If the dropdown list is empty ensure Time Schedule is pre-configured. Refer to Object Definition > Scheduling > Configuration tab.
Rule	The box is unchecked by default.	Click Enable box to activate this rule then save the settings.
Save	N/A	Click Save to save the settings.
Undo	N/A	Click X to cancel the settings and back to last page.

4G IIoT LoRa Gateway

5.2.2 URL Blocking

"URL Blocking" function can let you define blocking or allowing rules for incoming and outgoing Web request packets. With defined rules, gateway can control the Web requests containing the complete URL, partial domain name, or pre-defined keywords. For example, one can filter out or allow only the Web requests based on domain input suffixes like .com or .org or keywords like "bct" or "mpe".

An URL blocking rule should specify the URL, partial domain name, or included keywords in the Web requests from and to the gateway and also the destination service port. Besides, a certain time schedule can be applied to activate the URL Blocking rules during pre-defined time interval(s).

The gateway will logs and displays the disallowed web accessing requests that matched the defined URL blocking rule in the black-list or in the exclusion of the white-list.

When you choose "Allow all to pass except those match the following rules" for the "URL Blocking Rule List", you are setting the defined URL blocking rules to belong to the black list. The packets, listed in the rule list, will be blocked if one pattern in the requests matches to one rule. Other Web requests can pass through the gateway. In contrast, when you choose "Deny all to pass except those match the following rules" for the "URL Blocking Rule List", you are setting the defined packet filtering rules to belong to the white list. The Web requests, listed in the rule, will be allowed if one pattern in the requests matches to one rule. Other Web requests will be blocked.

URL Blocking Rule with Black List

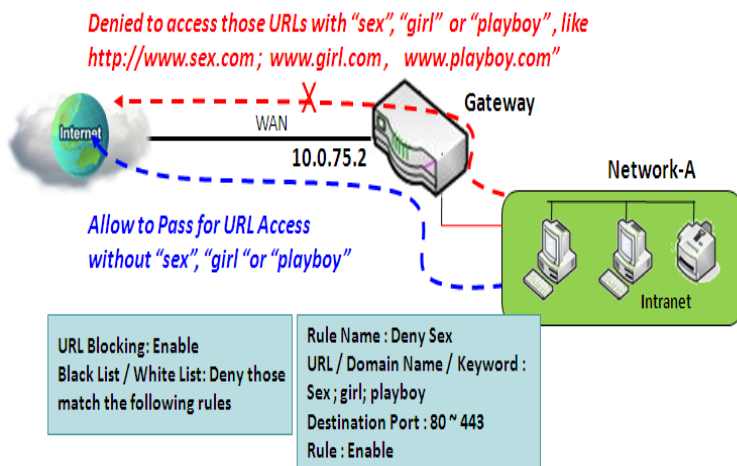

When the administrator of the gateway wants to block the Web requests with some dedicated patterns, he can use the "URL Blocking" function to block specific Web requests by defining the black list as shown in above diagram. Certainly, when the administrator wants to allow only the Web requests with some dedicated patterns to go through the gateway, he can also use the "URL Blocking" function by defining the white list to meet the requirement.

As shown in the diagram, enable the URL blocking function and create the first rule to deny the Web requests with "sex" or "sexygirl" patterns and the other to deny the Web requests with "playboy" pattern to go through the gateway. System will block the Web requests with "sex", "sexygirl" or "playboy" patterns to pass through the gateway.

4G IIoT LoRa Gateway

URL Blocking Setting

Go to **Security > Firewall > URL Blocking** Tab.

In "URL Blocking" page, there are three configuration windows. They are the "Configuration" window, "URL Blocking Rule List" window, and "URL Blocking Rule Configuration" window.

The "Configuration" window can let you activate the URL blocking function and specify to black listing or to white listing the packets defined in the "URL Blocking Rule List" entry. In addition, log alerting can be enabled to record on-going events for any disallowed Web request packets. Refer to "System Status" in "6.1.1 System Related" section in this user manual for how to view recorded log.

The "URL Blocking Rule List" window lists all your defined URL blocking rule entry. And finally, the "URL Blocking Rule Configuration" window can let you define URL blocking rules. The parameters in a rule include the rule name, the Source IP or MAC, the URL/Domain Name/Keyword, the destination service ports, the integrated time schedule rule and the rule activation.

Enable URL Blocking

Configuration	
Item	Setting
▶ URL Blocking	<input checked="" type="checkbox"/> Enable
▶ Black List / White List	Deny those match the following rules. ▼
▶ Log Alert	<input type="checkbox"/> Enable

Configuration		
Item	Value setting	Description
URL Blocking	The box is unchecked by default	Check the Enable box to activate URL Blocking function.
Black List / White List	Deny those match the following rules is set by default	Specify the URL Blocking Policy, either Black List or White List. Black List: When Deny those match the following rules is selected, as the name suggest, the matched Web request packets will be blocked. White List: When Allow those match the following rules is selected, the matched Web request packets can pass through the Gateway, and the others that don't match the rules will be blocked.
Log Alert	The box is unchecked by default	Check the Enable box to activate Event Log.
Save	NA	Click Save button to save the settings
Undo	NA	Click Undo button to cancel the settings

Create/Edit URL Blocking Rules

The Gateway supports up to a maximum of 20 URL blocking rule sets. Ensure that the URL Blocking is enabled before we can create blocking rules.

4G IIoT LoRa Gateway

ID	Rule Name	Source IP	Source MAC	URL / Domain Name / Keyword	Destination Port	Time Schedule	Enable	Actions
----	-----------	-----------	------------	-----------------------------	------------------	---------------	--------	---------

When **Add** button is applied, the **URL Blocking Rule Configuration** screen will appear.

Item	Setting
▶ Rule Name	Rule1
▶ Source IP	Any
▶ Source MAC	Any
▶ URL / Domain Name / Keyword	
▶ Destination Port	Any
▶ Time Schedule Rule	(0) Always
▶ Rule	<input type="checkbox"/> Enable

Item	Value setting	Description
Rule Name	<ol style="list-style-type: none"> String format can be any text A Must filled setting 	Specify an URL Blocking rule name. Enter a name that is easy for you to understand.
Source IP	<ol style="list-style-type: none"> A Must filled setting Any is set by default 	This field is to specify the Source IP address . <ul style="list-style-type: none"> Select Any to filter packets coming from any IP addresses. Select Specific IP Address to filter packets coming from an IP address entered in this field. Select IP Range to filter packets coming from a specified range of IP address entered in this field. Select IP Address-based Group to filter packets coming from a pre-defined group selected. Note: group must be pre-defined before this option become available. Refer to Object Definition > Grouping > Host grouping.
Source MAC	<ol style="list-style-type: none"> A Must filled setting Any is set by default 	This field is to specify the Source MAC address . <ul style="list-style-type: none"> Select Any to filter packets coming from any MAC addresses. Select Specific MAC Address to filter packets coming from a MAC address entered in this field. Select MAC Address-based Group to filter packets coming from a pre-defined group selected. Note: group must be pre-defined before this selection become available. Refer to Object Definition > Grouping > Host grouping.
URL / Domain Name / Keyword	<ol style="list-style-type: none"> A Must filled setting Supports up to a maximum of 10 Keywords in a rule by using the delimiter “;”. 	Specify URL, Domain Name, or Keyword list for URL checking. <ul style="list-style-type: none"> In the Black List mode, if a matched rule is found, the packets will be dropped. In the White List mode, if a matched rule is found, the packets will be accepted and the others which don’t match any rule will be dropped.
Destination Port	<ol style="list-style-type: none"> A Must filled setting Any is set by default 	This field is to specify the Destination Port number . <ul style="list-style-type: none"> Select Any to filter packets going to any Port. Select Specific Service Port to filter packets going to a specific Port entered in this field. Select Port Range to filter packets going to a specific range of Ports entered in this field.
Time Schedule Rule	A Must filled setting	Apply a specific Time Schedule to this rule; otherwise leave it as (0) Always . If the dropdown list is empty ensure Time Schedule is pre-configured. Refer to Object Definition > Scheduling > Configuration tab.

4G IIoT LoRa Gateway

Rule	The box is unchecked by default.	Click the Enable box to activate this rule.
Save	<i>NA</i>	Click the Save button to save the settings.
Undo	<i>NA</i>	Click the X button to cancel the changes and back to last page.

4G IIoT LoRa Gateway

5.2.3 MAC Control

Configuration

Item	Setting
MAC Control	<input checked="" type="checkbox"/> Enable
Black List / White List	Deny MAC Address Below. ▾
Log Alert	<input type="checkbox"/> Enable
Known MAC from LAN PC List	▾ Copy to

MAC Control Rule List Add Delete

ID	Rule Name	MAC Address	Time Schedule Rule	Enable	Actions
----	-----------	-------------	--------------------	--------	---------

"MAC Control" function allows you to assign the accessibility to the gateway for different users based on device's MAC address. When the administrator wants to reject the traffics from some client hosts with specific MAC addresses, he can use the "MAC Control" function to reject with the black list configuration.

MAC Control with Black List Scenario

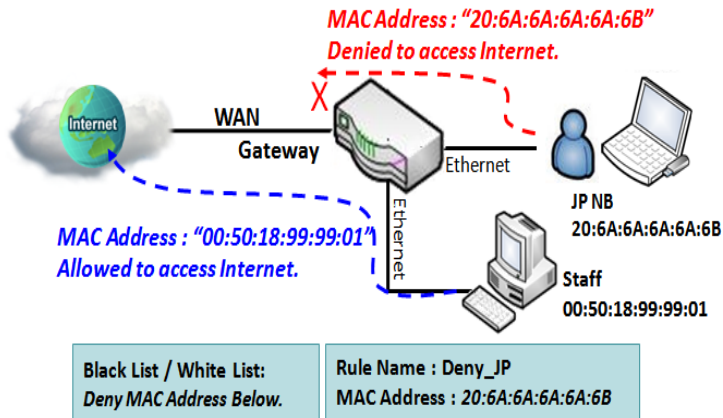

As shown in the diagram, enable the MAC control function and specify the "MAC Control Rule List" is a black list, and configure one MAC control rule for the gateway to deny the connection request from the "JP NB" with its own MAC address 20:6A:6A:6A:6A:6B.

System will block the connecting from the "JP NB" to the gateway but allow others.

4G IIoT LoRa Gateway

MAC Control Setting

Go to **Security > Firewall > MAC Control** Tab.

The MAC control setting allows user to create and customize MAC address policies to allow or reject packets with specific source MAC address.

Enable MAC Control

Configuration	
Item	Setting
▶ MAC Control	<input type="checkbox"/> Enable
▶ Black List / White List	Deny MAC Address Below. ▼
▶ Log Alert	<input type="checkbox"/> Enable
▶ Known MAC from LAN PC List	▼ <input type="button" value="Copy to"/>

Configuration Window		
Item	Value setting	Description
MAC Control	The box is unchecked by default	Check the Enable box to activate the MAC filter function
Black List / White List	Deny MAC Address Below is set by default	When Deny MAC Address Below is selected, as the name suggest, packets specified in the rules will be blocked –black listed. In contrast, with Allow MAC Address Below , you can specifically white list the packets to pass and the rest will be blocked.
Log Alert	The box is unchecked by default	Check the Enable box to activate to activate Event Log.
Known MAC from LAN PC List	N/A	Select a MAC Address from LAN Client List. Click the Copy to to copy the selected MAC Address to the filter rule.
Save	N/A	Click Save to save the settings
Undo	N/A	Click Undo to cancel the settings

4G IIoT LoRa Gateway

Create/Edit MAC Control Rules

The gateway supports up to a maximum of 20 filter rule sets. Ensure that the MAC Control is enabled before we can create control rules.

MAC Control Rule List					
ID	Rule Name	MAC Address	Time Schedule Rule	Enable	Actions

When **Add** button is applied, **Filter Rule Configuration** screen will appear.

MAC Control Rule Configuration			
Rule Name	MAC Address (Use : to Compose)	Time Schedule	Enable
<input type="text" value="Rule1"/>	<input type="text"/>	(0) Always ▾	<input type="checkbox"/>
<input type="button" value="Save"/>			

Item	Value setting	Description
Rule Name	1. String format can be any text 2. A Must fill setting	Enter a MAC Control rule name. Enter a name that is easy for you to remember.
MAC Address (Use: to Compose)	1. MAC Address string Format 2. A Must fill setting	Specify the Source MAC Address to filter rule.
Time Schedule	A Must fill setting	Apply Time Schedule to this rule; otherwise leave it as (0) Always . If the dropdown list is empty, ensure Time Schedule is pre-configured. Refer to Object Definition > Scheduling > Configuration tab
Enable	The box is unchecked by default.	Click Enable box to activate this rule, and then save the settings.
Save	N/A	Click Save to save the settings
Undo	N/A	Click Undo to cancel the settings

4G IIoT LoRa Gateway

5.2.4 Content Filter (not supported)

Not supported feature for the purchased product, leave it as blank.

4G IIoT LoRa Gateway

5.2.5 Application Filter (not supported)

Not supported feature for the purchased product, leave it as blank.

4G IIoT LoRa Gateway

5.2.6 IPS

Configuration	
Item	Setting
▶ IPS	<input type="checkbox"/> Enable
▶ Log Alert	<input type="checkbox"/> Enable

Intrusion Prevention	
Item	Setting
▶ SYN Flood Defense	<input type="checkbox"/> Enable <input type="text" value="300"/> Packets/second (10~10000)
▶ UDP Flood Defense	<input type="checkbox"/> Enable <input type="text" value="300"/> Packets/second (10~10000)
▶ ICMP Flood Defense	<input type="checkbox"/> Enable <input type="text" value="300"/> Packets/second (10~10000)
▶ Port Scan Defense	<input type="checkbox"/> Enable <input type="text" value="200"/> Packets/second (10~10000)

To provide application servers in the Internet, administrator may need to open specific ports for the services. However, there are some risks to always open service ports in the Internet. In order to avoid such attack risks, it is important to enable IPS functions.

Intrusion Prevention System (IPS) is network security appliances that monitor network and/or system activities for malicious activity. The main functions of IPS are to identify malicious activity, log information about this activity, attempt to block/stop it and report it. You can enable the IPS function and check the listed intrusion activities when needed. You can also enable the log alerting so that system will record Intrusion events when corresponding intrusions are detected.

IPS Scenario

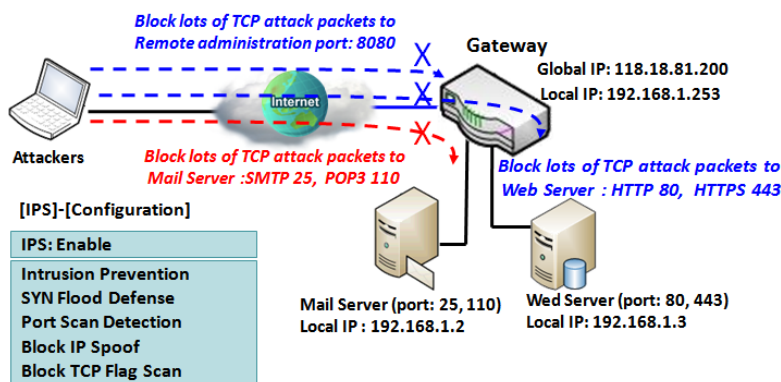

As shown in the diagram, the gateway serves as an E-mail server, Web Server and also provides TCP port 8080 for remote administration. So, remote users or unknown users can request those services from Internet. With IPS enabled, the gateway can detect incoming attack packets, including the TCP ports (25, 80, 110, 443 and 8080) with services. It will block the attack packets and let the normal access to pass through the gateway

4G IIoT LoRa Gateway

IPS Setting

Go to **Security > Firewall > IPS** Tab.

The Intrusion Prevention System (IPS) setting allows user to customize intrusion prevention rules to prevent malicious packets.

Enable IPS Firewall

Configuration	
Item	Setting
▶ IPS	<input type="checkbox"/> Enable
▶ Log Alert	<input type="checkbox"/> Enable

Configuration Window		
Item	Value setting	Description
IPS	The box is unchecked by default	Check the Enable box to activate IPS function
Log Alert	The box is unchecked by default	Check the Enable box to activate to activate Event Log.
Save	N/A	Click Save to save the settings
Undo	N/A	Click Undo to cancel the settings

Setup Intrusion Prevention Rules

The router allows you to select intrusion prevention rules you may want to enable. Ensure that the IPS is enabled before we can enable the defense function.

4G IIoT LoRa Gateway

Intrusion Prevention	
Item	Setting
▶ SYN Flood Defense	<input type="checkbox"/> Enable <input type="text" value="300"/> Packets/second (10~10000)
▶ UDP Flood Defense	<input type="checkbox"/> Enable <input type="text" value="300"/> Packets/second (10~10000)
▶ ICMP Flood Defense	<input type="checkbox"/> Enable <input type="text" value="300"/> Packets/second (10~10000)
▶ Port Scan Defense	<input type="checkbox"/> Enable <input type="text" value="200"/> Packets/second (10~10000)
▶ Block Land Attack	<input type="checkbox"/> Enable
▶ Block Ping of Death	<input type="checkbox"/> Enable
▶ Block IP Spoof	<input type="checkbox"/> Enable
▶ Block TCP Flag Scan	<input type="checkbox"/> Enable
▶ Block Smurf	<input type="checkbox"/> Enable
▶ Block Traceroute	<input type="checkbox"/> Enable
▶ Block Fraggle Attack	<input type="checkbox"/> Enable
▶ ARP Spoofing Defense	<input type="checkbox"/> Enable <input type="text" value="300"/> Packets/second (10~10000)

Setup Intrusion Prevention Rules		
Item Name	Value setting	Description
SYN Flood Defense	1. A Must filled setting	Click Enable box to activate this intrusion prevention rule and enter the traffic threshold in this field.
UDP Flood Defense	2. The box is unchecked by default.	Click Enable box to activate this intrusion prevention rule and enter the traffic threshold in this field.
ICMP Flood Defense	3. Traffic threshold is set to 300 by default	Click Enable box to activate this intrusion prevention rule and enter the traffic threshold in this field.
	4. The value range can be from 10 to 10000.	<u>Value Range: 10 ~ 10000.</u>
Port Scan Defection	1. A Must filled setting	Click Enable box to activate this intrusion prevention rule and enter the traffic threshold in this field.
	2. The box is unchecked by default.	
	3. Traffic threshold is set to 200 by default	
	4. The value range can be from 10 to 10000.	<u>Value Range: 10 ~ 10000.</u>
Block Land Attack		
Block Ping of Death		
Block IP Spoof		
Block TCP Flag Scan	The box is unchecked by default.	Click Enable box to activate this intrusion prevention rule.
Block Smurf		
Block Traceroute		
Block Fraggle		

4G IIoT LoRa Gateway

Attack		
ARP Spoofing Defence	<ol style="list-style-type: none">1. A Must filled setting2. The box is unchecked by default.3. Traffic threshold is set to 300 by default4. The value range can be from 10 to 10000.	Click Enable box to activate this intrusion prevention rule and enter the traffic threshold in this field. <i>Value Range: 10 ~ 10000.</i>
Save	NA	Click Save to save the settings
Undo	NA	Click Undo to cancel the settings

4G IIoT LoRa Gateway

5.2.7 Options

Firewall Options							
Item		Setting					
▶ Stealth Mode		<input type="checkbox"/> Enable					
▶ SPI		<input type="checkbox"/> Enable					
▶ Discard Ping from WAN		<input type="checkbox"/> Enable					

Remote Administrator Host Definition							
ID	Interface	Protocol	IP	Subnet Mask	Service Port	Enable	Action
1	All WAN	HTTP	Any IP	N/A	80	<input checked="" type="checkbox"/>	Edit
2	All WAN	HTTPS	Any IP	N/A	443	<input checked="" type="checkbox"/>	Edit
3	All WAN	HTTP	Any IP	N/A	80	<input type="checkbox"/>	Edit
4	All WAN	HTTP	Any IP	N/A	80	<input type="checkbox"/>	Edit
5	All WAN	HTTP	Any IP	N/A	80	<input type="checkbox"/>	Edit

There are some additional useful firewall options in this page.

“Stealth Mode” lets gateway not to respond to port scans from the WAN so that makes it less susceptible to discovery and attacks on the Internet. “SPI” enables gateway to record the packet information like IP address, port address, ACK, SEQ number and so on while they pass through the gateway, and the gateway checks every incoming packet to detect if this packet is valid.

“Discard Ping from WAN” makes any host on the WAN side can’t ping this gateway. And finally, “Remote Administrator Hosts” enables you to perform administration task from a remote host. If this feature is enabled, only specified IP address(es) can perform remote administration.

4G IIoT LoRa Gateway

Enable SPI Scenario

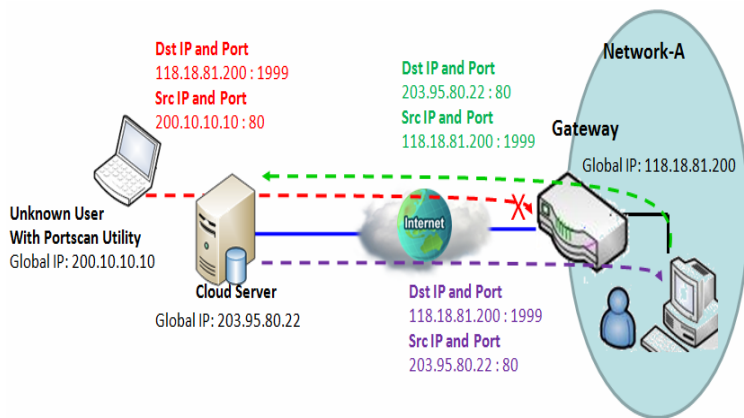

As shown in the diagram, Gateway has the IP address of 118.18.81.200 for WAN interface and 192.168.1.253 for LAN interface. It serves as a NAT gateway. Users in Network-A initiate to access cloud server through the gateway. Sometimes, unknown users will simulate the packets but use different source IP to masquerade. With the SPI feature been enabled at the gateway, it will block such packets from unknown users.

Discard Ping from WAN & Remote Administrator Hosts Scenario

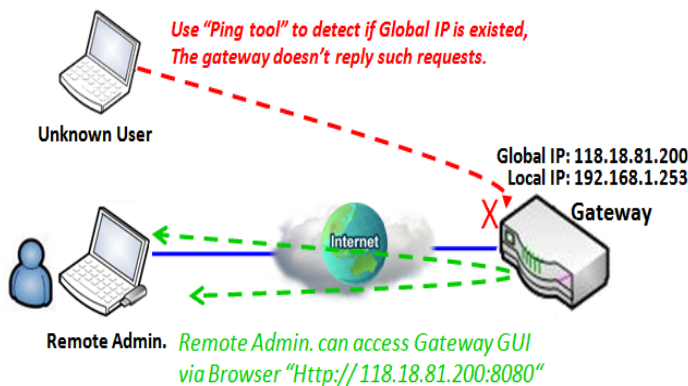

“Discard Ping from WAN” makes any host on the WAN side can't ping this gateway reply any ICMP packets. Enable the Discard Ping from WAN function to prevent security leak when local users surf the internet.

Remote administrator knows the gateway's global IP, and he can access the Gateway GUI via TCP port 8080.

4G IIoT LoRa Gateway

Firewall Options Setting

Go to **Security > Firewall > Options** Tab.

The firewall options setting allows network administrator to modify the behavior of the firewall and to enable Remote Router Access Control.

Enable Firewall Options

Firewall Options	
Item	Setting
▶ Stealth Mode	<input type="checkbox"/> Enable
▶ SPI	<input checked="" type="checkbox"/> Enable
▶ Discard Ping from WAN	<input type="checkbox"/> Enable

Firewall Options		
Item	Value setting	Description
Stealth Mode	The box is unchecked by default	Check the Enable box to activate the Stealth Mode function
SPI	The box is checked by default	Check the Enable box to activate the SPI function
Discard Ping from WAN	The box is unchecked by default	Check the Enable box to activate the Discard Ping from WAN function

Define Remote Administrator Host

The router allows network administrator to manage router remotely. The network administrator can assign specific IP address and service port to allow accessing the router.

4G IIoT LoRa Gateway

Remote Administrator Host Definition							
ID	Interface	Protocol	IP	Subnet Mask	Service Port	Enable	Action
1	All WAN	HTTP	Any IP	N/A	80	<input checked="" type="checkbox"/>	Edit
2	All WAN	HTTPS	Any IP	N/A	443	<input checked="" type="checkbox"/>	Edit
3	All WAN	HTTP	Any IP	N/A	80	<input type="checkbox"/>	Edit
4	All WAN	HTTP	Any IP	N/A	80	<input type="checkbox"/>	Edit
5	All WAN	HTTP	Any IP	N/A	80	<input type="checkbox"/>	Edit

Remote Administrator Host Definition		
Item	Value setting	Description
Protocol	HTTP is set by default	Select HTTP or HTTPS method for router access.
IP	A Must filled setting	This field is to specify the remote host to assign access right for remote access. Select Any IP to allow any remote hosts Select Specific IP to allow the remote host coming from a specific subnet. An IP address entered in this field and a selected Subnet Mask to compose the subnet.
Service Port	1. 80 for HTTP by default 2. 443 for HTTPS by default	This field is to specify a Service Port to HTTP or HTTPS connection. Value Range: 1 ~ 65535.
Enabling the rule	The box is unchecked by default.	Click Enable box to activate this rule.
Save	N/A	Click Enable box to activate this rule then save the settings.
Undo	N/A	Click Undo to cancel the settings

Chapter 6 Administration

6.1 Configure & Manage

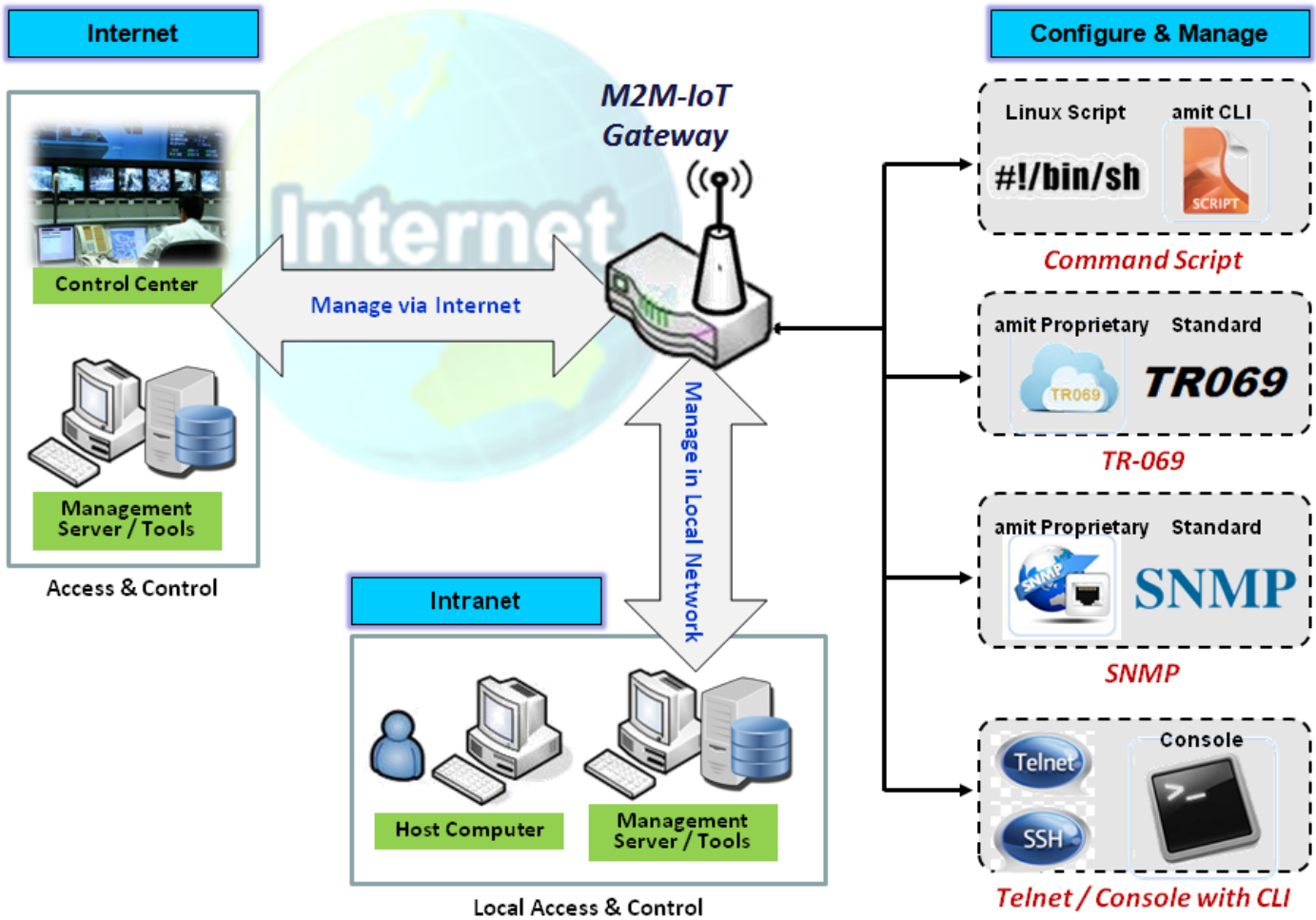

Configure & Manage refers to enterprise-wide administration of distributed systems including (and commonly in practice) computer systems. Centralized management has a time and effort trade-off that is related to the size of the company, the expertise of the IT staff, and the amount of technology being used. This device supports many system management protocols, such as Command Script, TR-069, SNMP, and Telnet with CLI. You can setup those configurations in the "Configure & Manage" section.

4G IIoT LoRa Gateway

6.1.1 Command Script

Command script configuration is the application that allows administrator to setup the pre-defined configuration in plain text style and apply configuration on startup.

Go to **Administration > Command Script > Configuration Tab**.

Enable Command Script Configuration

Configuration	
Item	Setting
▶ Command Script	<input type="checkbox"/> Enable
▶ Backup Script	Via Web UI
▶ Upload Script	Via Web UI
▶ Script Name	<input type="text"/>
▶ Version	<input type="text"/>
▶ Description	<input type="text"/>
▶ Update time	2019-04-08T18:05:31

Configuration Item	Value setting	Description
Command Script	The box is unchecked by default	Check the Enable box to activate the Command Script function.
Backup Script	N/A	Click the Via Web UI or Via Storage button to backup the existed command script in a .txt file. You can specify the script file name in Script Name below.
Upload Script	N/A	Click the Via Web UI or Via Storage button to Upload the existed command script from a specified .txt file.
Script Name	1.An Optional setting 2.Any valid file name	Specify a script file name for script backup, or display the selected upload script file name. Value Range: 0 ~ 32 characters.
Version	1.An Optional setting 2.Any string	Specify the version number for the applied Command script. Value Range: 0 ~ 32 characters.
Description	1.An Optional setting 2.Any string	Enter a short description for the applied Command script.
Update time	N/A	It records the upload time for last commad script upload.

4G IIoT LoRa Gateway

Edit/Backup Plain Text Command Script

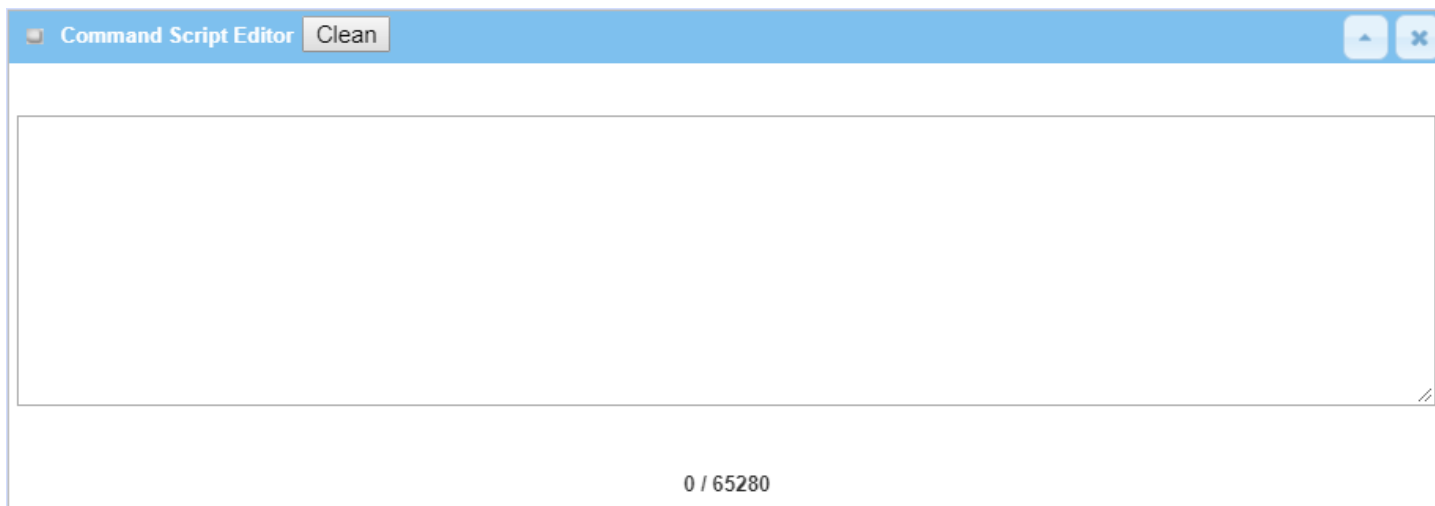

You can edit the plain text configuration settings in the configuration screen as above.

Plain Text Configuration		
Item	Value setting	Description
Clean	NA	Clean text area. (You should click Save button to further clean the configuration already saved in the system.)
Backup	NA	Backup and download configuration.
Save	NA	Save configuration

The supported plain text configuration items are shown in the following list. For the settings that can be executed with standard Linux commands, you can put them in a script file, and apply to the system configure with **STARTUP** command. For those configurations without corresponding Linux command set to configure, you can configure them with proprietary command set.

Configuration Content		
Key	Value setting	Description
OPENVPN_ENABLED	1 : enable 0 : disable	Enable or disable OpenVPN Client function.
OPENVPN_DESCRIPTION	A Must filled Setting	Specify the tunnel name for the OpenVPN Client connection.
OPENVPN_PROTO	udp tcp	Define the Protocol for the OpenVPN Client. <ul style="list-style-type: none">• Select TCP or TCP /UDP ->The OpenVPN will use TCP protocol, and Port will be set as 443 automatically.• Select UDP -> The OpenVPN will use UDP protocol, and Port will be set as 1194 automatically.
OPENVPN_PORT	A Must filled Setting	Specify the Port for the OpenVPN Client to use.
OPENVPN_REMOTE_IPADDR	IP or FQDN	Specify the Remote IP/FQDN of the peer OpenVPN Server for this OpenVPN Client tunnel. Fill in the IP address or FQDN.
OPENVPN_PING_INTVL	seconds	Specify the time interval for OpenVPN keep-alive checking.

4G IIoT LoRa Gateway

OPENVPN_PING_TOUT	seconds	Specify the timeout value for OpenVPN Client keep-alive checking.
OPENVPN_COMP	Adaptive	Specify the LZO Compression algorithm for OpenVPN client.
OPENVPN_AUTH	Static Key/TLS	Specify the authorization mode for the OpenVPN tunnel. <ul style="list-style-type: none"> • TLS ->The OpenVPN will use TLS authorization mode, and the following items CA Cert., Client Cert. and Client Key need to specify as well.
OPENVPN_CA_CERT	A Must filled Setting	Specify the Trusted CA certificate for the OpenVPN client. It will go through Base64 Conversion.
OPENVPN_LOCAL_CERT	A Must filled Setting	Specify the local certificate for OpenVPN client. It will go through Base64 Conversion.
OPENVPN_LOCAL_KEY	A Must filled Setting	Specify the local key for the OpenVPN client. It will go through Base64 Conversion.
OPENVPN_EXTRA_OPTS	Options	Specify the extra options setting for the OpenVPN client.
IP_ADDR1	Ip	Ethernet LAN IP
IP_NETM1	Net mask	Ethernet LAN MASK
PPP_MONITORING	1 : enable 0 : disable	When the Network Monitoring feature is enabled, the router will use DNS Query or ICMP to periodically check Internet connection – connected or disconnected.
PPP_PING	0 : DNS Query 1 : ICMP Query	With DNS Query , the system checks the connection by sending DNS Query packets to the destination specified in PPP_PING_IPADDR. With ICMP Query , the system will check connection by sending ICMP request packets to the destination specified in PPP_PING_IPADDR.
PPP_PING_IPADDR	IP	Specify an IP address as the target for sending DNS query/ICMP request.
PPP_PING_INTVL	seconds	Specify the time interval for between two DNS Query or ICMP checking packets.
STARTUP	Script file	For the configurations that can be configured with standard Linux commands, you can put them in a script file, and apply the script file with STARTUP command. For example, STARTUP=#!/bin/sh STARTUP=echo "startup done" > /tmp/demo

Plain Text System Configuration with Telnet

In addition to the web-style plain text configuration as mentioned above, the gateway system also allow the configuration via Telnet CLI. Administrator can use the proprietary telnet command "**txtConfig**" and related action items to perform the plain system configuration.

The command format is: `txtConfig (action) [option]`

Action	Option	Description
clone	<i>Output file</i>	Duplicate the configuration content from database and stored as a configuration file. (ex: <code>txtConfig clone /tmp/config</code>) The contents in the configuration file are the same as the plain text commands mentioned above. This action is exactly the same as performing the "Backup" plain text configuration.

4G IIoT LoRa Gateway

commit	a existing file	Commit the configuration content to database. (ex: <i>txtConfig commit /tmp/config</i>)
enable	NA	Enable plain text system config. (ex: <i>txtConfig enable</i>)
disable	NA	Disable plain text system config. (ex: <i>txtConfig disable</i>)
run_immediately	NA	Apply the configuration content that has been committed in database. (ex: <i>txtConfig run_immediately</i>)
run_immediately	a existing file	Assign a configuration file to apply. (ex: <i>txtConfig run_immediately /tmp/config</i>)

4G IIoT LoRa Gateway

6.1.2 TR-069

TR-069 (Technical Report 069) is a Broadband Forum technical specification entitled CPE WAN Management Protocol (CWMP). It defines an application layer protocol for remote management of end-user devices, like this gateway device. As a bidirectional SOAP/HTTP-based protocol, it provides the communication between customer-premises equipment (CPE) and Auto Configuration Servers (ACS). The Security Gateway is such CPE.

TR-069 is a customized feature for ISP. It is not recommend that you change the configuration for this. If you have any problem in using this feature for device management, please contact with your ISP or the ACS provider for help. At the right upper corner of TR-069 Setting screen, one “[Help]” command let you see the same message about that.

Scenario - Managing deployed gateways through an ACS Server

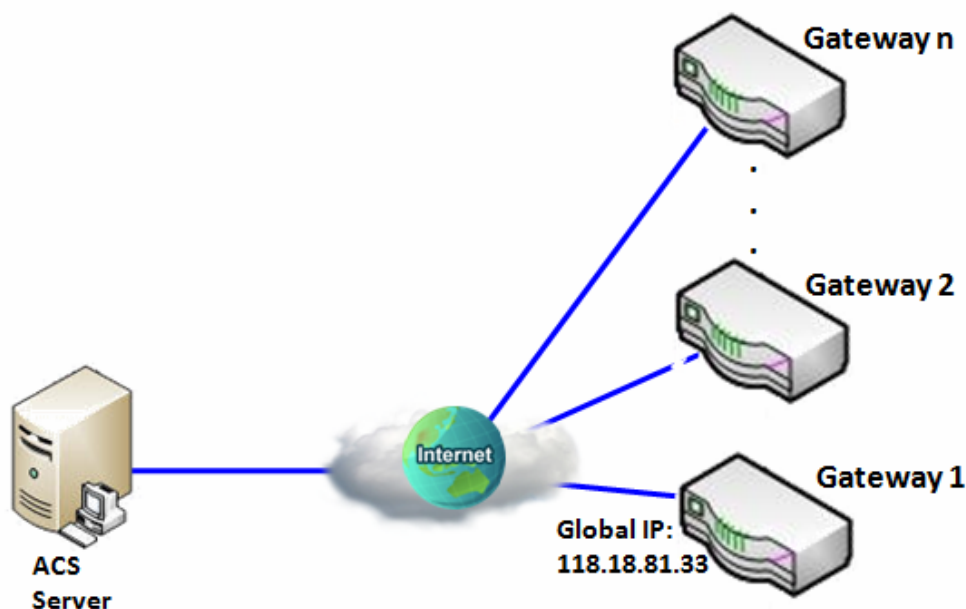

Scenario Application Timing

When the enterprise data center wants to use an ACS server to manage remote gateways geographically distributed elsewhere in the world, the gateways in all branch offices must have an embedded TR-069 agent to communicate with the ACS server. So that the ACS server can configure, FW upgrade and monitor these gateways and their corresponding Intranets.

Scenario Description

The ACS server can configure, upgrade with latest FW and monitor these gateways.

Remote gateways inquire the ACS server for jobs to do in each time period.

The ACS server can ask the gateways to execute some urgent jobs.

4G IIoT LoRa Gateway

Parameter Setup Example

Following tables list the parameter configuration as an example for the Gateway 1 in above diagram with "TR-069" enabling.

Use default value for those parameters that are not mentioned in the tables.

Configuration Path	[TR-069]-[Configuration]
TR-069	■ <i>Enable</i>
ACS URL	http://qa.acslite.com/cpe.php
ACS User Name	<i>ACSUserName</i>
ACS Password	<i>ACSPassword</i>
ConnectionRequest Port	<i>8099</i>
ConnectionRequest User Name	<i>ConnReqUserName</i>
ConnectionRequest Password	<i>ConnReqPassword</i>
Inform	■ <i>Enable Interval 900</i>

Scenario Operation Procedure

In above diagram, the ACS server can manage multiple gateways in the Internet. The "Gateway 1" is one of them and has 118.18.81.33 IP address for its WAN-1 interface.

When all remote gateways have booted up, they will try to connect to the ACS server.

Once the connections are established successfully, the ACS server can configure, upgrade with latest FW and monitor these gateways.

Remote gateways inquire the ACS server for jobs to do in each time period.

If the ACS server needs some urgent jobs to be done by the gateways, it will issue the "Connection Request" command to those gateways. And those gateways make immediate connections in response to the ACS server's immediate connection request for executing the urgent jobs.

4G IIoT LoRa Gateway

TR-069 Setting

Go to **Administration > Configure & Manage > TR-069** tab.

In "TR-069" page, there is only one configuration window for TR-069 function. In the window, you must specify the related information for your security gateway to connect to the ACS. Drive the function to work by specifying the URL of the ACS server, the account information to login the ACS server, the service port and the account information for connection requesting from the ACS server, and the time interval for job inquiry. Except the inquiry time, there are no activities between the ACS server and the gateways until the next inquiry cycle. But if the ACS server has new jobs that are expected to do by the gateways urgently, it will ask these gateways by using connection request related information for immediate connection for inquiring jobs and executing.

Enable TR-069

Configuration	
Item	Setting
▶ TR-069	<input type="checkbox"/> Enable
▶ Interface	WAN-1 ▼
▶ Data model	ACS Cloud Data Model ▼
▶ ACS URL	<input type="text"/>
▶ ACS UserName	<input type="text"/>
▶ ACS Password	<input type="text"/>
▶ Connection Request Port	8099
▶ Connection Request UserName	<input type="text"/>
▶ Connection Request Password	<input type="text"/>
▶ Inform	<input checked="" type="checkbox"/> Enable Interval <input type="text" value="300"/>
▶ Certification Setup	<input checked="" type="radio"/> default <input type="radio"/> Select from Certificate List Certificate: CA ▼

TR-069

Item	Value setting	Description
------	---------------	-------------

4G IIoT LoRa Gateway

TR-069	The box is unchecked by default	Check the Enable box to activate TR-069 function.
Interface	WAN-1 is selected by default.	When you finish set basic network WAN-1 ~ WAN-n, you can choose WAN-1 ~ WAN-n When you finish set Security > VPN > IPSec/OpenVPN/PPTP/L2TP/GRE, you can choose IPSec/OpenVPN/PPTP/L2TP/GRE tunnel, the interface just like "IPSec #1"
Data Model	ACS Cloud Data Model is selected by default.	Select the TR-069 dat model for the remote management. Standard : the ACS Server is a standard one, which is fully comply with TR-069. ACS Cloud Data Model : Select this data model if you intend to use Cloud ACS Server to managing the deployed gateways.
ACS URL	A Must filled setting	You can ask ACS manager provide ACS URL and manually set
ACS Username	A Must filled setting	You can ask ACS manager provide ACS username and manually set
ACS Password	A Must filled setting	You can ask ACS manager provide ACS password and manually set
ConnectionRequest Port	1. A Must filled setting. 2. By default 8099 is set.	You can ask ACS manager provide ACS ConnectionRequest Port and manually set <u>Value Range</u> : 0 ~ 65535.
ConnectionRequest UserName	A Must filled setting	You can ask ACS manager provide ACS ConnectionRequest Username and manually set
ConnectionRequest Password	A Must filled setting	You can ask ACS manager provide ACS ConnectionRequest Password and manually set
Inform	1. The box is checked by default. 2. The Interval value is 300 by default.	When the Enable box is checked, the gateway (CPE) will periodically send inform message to ACS Server according to the Interval setting. <u>Value Range</u> : 0 ~ 86400 for Inform Interval.
Certification Setup	The default box is selected by default	You can leave it as default or select an expected certificate and key from the drop down list. Refer to Object Definition > Certificate Section for the Certificate configuration.
Save	N/A	Click Save to save the settings.
Undo	N/A	Click Undo to cancel the modifications.

When you finish set **ACS URL ACS Username ACS Password**, your gateway (CPE, Client Premium Equipment) can send inform to ACS Server.

When you finish set **ConnectionRequest Port ConnectionRequest Username ConnectionRequest Password**, ACS Server can ask the gateway (CPE) to send inform to ACS Server.

Enable STUN Server

4G IIoT LoRa Gateway

STUN Settings	
Item	Setting
▶ STUN	<input checked="" type="checkbox"/> Enable
▶ Server Address	<input type="text"/>
▶ Server Port	<input type="text" value="3478"/> (1~65535)
▶ Keep Alive Period	<input type="text" value="0"/> (0~65535)second(s)

STUN Settings Configuration		
Item	Value setting	Description
STUN	The box is checked by default	Check the Enable box to activate STUN function.
Server Address	<ol style="list-style-type: none"> String format: any IPv4 address It is an optional item. 	Specify the IP address for the expected STUN Server.
Server Port	<ol style="list-style-type: none"> An optional setting 3478 is set by default 	Specify the port number for the expected STUN Server. <u>Value Range:</u> 1 ~ 65535.
Keep Alive Period	<ol style="list-style-type: none"> An optional setting 0 is set by default 	Specify the keep alive time period for the connection with STUN Server. <u>Value Range:</u> 0 ~ 65535.
Save	N/A	Click Save to save the settings.
Undo	N/A	Click Undo to cancel the modifications.

4G IIoT LoRa Gateway

6.1.3 SNMP

In brief, SNMP, the Simple Network Management Protocol, is a protocol designed to give a user the capability to remotely manage a computer network by polling and setting terminal values and monitoring network events.

In typical SNMP uses, one or more administrative computers, called managers, have the task of monitoring or managing a group of hosts or devices on a computer network. Each managed system executes, at all times, a software component called an agent which reports information via SNMP to the manager.

SNMP agents expose management data on the managed systems as variables. The protocol also permits active management tasks, such as modifying and applying a new configuration through remote modification of these variables. The variables accessible via SNMP are organized in hierarchies. These hierarchies, and other metadata (such as type and description of the variable), are described by Management Information Bases (MIBs).

The device supports several public MIBs and one private MIB for the SNMP agent. The supported MIBs are as follow: MIB-II (RFC 1213, Include IPv6), IF-MIB, IP-MIB, TCP-MIB, UDP-MIB, SMIv1 and SMIv2, SNMPv2-TM and SNMPv2-MIB, and AMIB (a Proprietary MIB)

SNMP Management Scenario

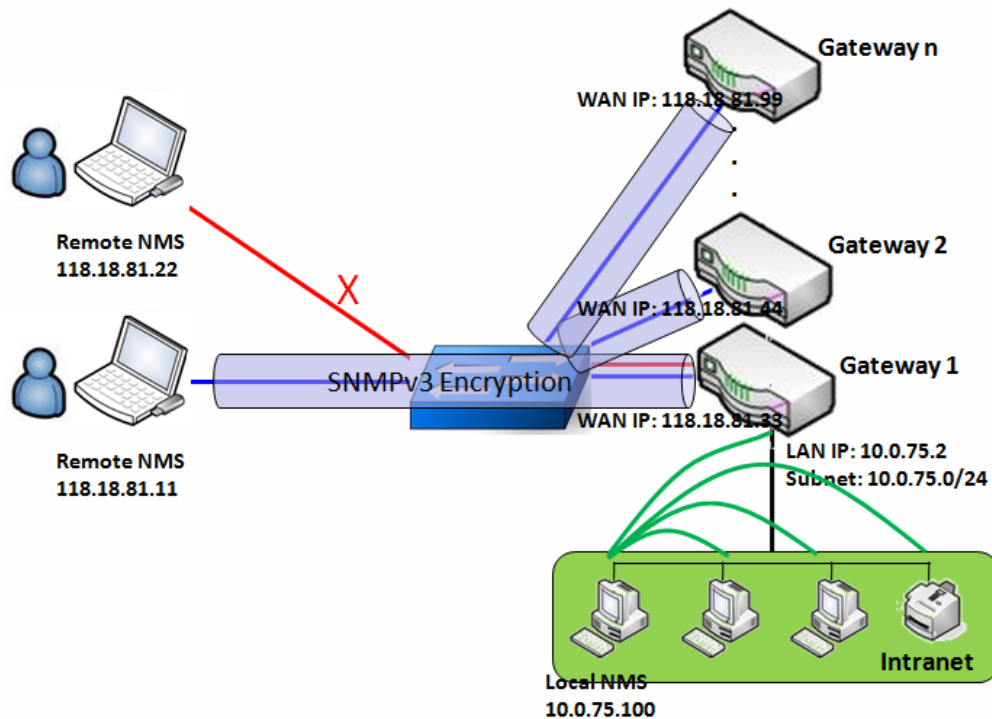

Scenario Application Timing

There are two application scenarios of SNMP Network Management Systems (NMS). Local NMS is in

4G IIoT LoRa Gateway

the Intranet and manage all devices that support SNMP protocol in the Intranet. Another one is the Remote NMS to manage some devices whose WAN interfaces are connected together by using a switch or a router with UDP forwarding. If you want to manage some devices and they all have supported SNMP protocol, use either one application scenario, especially the management of devices in the Intranet. In managing devices in the Internet, the TR-069 is the better solution. Please refer to last sub-section.

Scenario Description

The NMS server can monitor and configure the managed devices by using SNMP protocol, and those devices are located at where UDP packets can reach from NMS.

The managed devices report urgent trap events to the NMS servers.

Use SNMPv3 version of protocol can protected the transmitting of SNMP commands and responses.

The remote NMS with privilege IP address can manage the devices, but other remote NMS can't.

Parameter Setup Example

Following tables list the parameter configuration as an example for the Gateway 1 in above diagram with "SNMP" enabling at LAN and WAN interfaces.

Use default value for those parameters that are not mentioned in the tables.

Configuration Path	[SNMP]-[Configuration]
SNMP Enable	■ LAN ■ WAN
Supported Versions	■ v1 ■ v2c ■ v3
Get / Set Community	ReadCommunity / WriteCommunity
Trap Event Receiver 1	118.18.81.11
WAN Access IP Address	118.18.81.11

Configuration Path	[SNMP]-[User Privacy Definition]		
ID	1	2	3
User Name	UserName1	UserName2	UserName3
Password	Password1	Password2	Disable
Authentication	MD5	SHA-1	Disable
Encryption	DES	Disable	Disable
Privacy Mode	authPriv	authNoPriv	noAuthNoPriv
Privacy Key	12345678	Disable	Disable
Authority	Read/Write	Read	Read
Enable	■ Enable	■ Enable	■ Enable

Scenario Operation Procedure

In above diagram, the NMS server can manage multiple devices in the Intranet or a UDP-reachable network. The "Gateway 1" is one of the managed devices, and it has the IP address of 10.0.75.2 for

4G IIoT LoRa Gateway

LAN interface and 118.18.81.33 for WAN-1 interface. It serves as a NAT router.

At first stage, the NMS manager prepares related information for all managed devices and records them in the NMS system. Then NMS system gets the status of all managed devices by using SNMP get commands.

When the manager wants to configure the managed devices, the NMS system allows him to do that by using SNMP set commands. The "UserName1" account is used if the manager uses SNMPv3 protocol for configuring the "Gateway 1". Only the "UserName1" account can let the "Gateway 1" accept the configuration from the NMS since the authority of the account is "Read/Write".

Once a managed device has an urgent event to send, the device will issue a trap to the Trap Event Receivers. The NMS itself could be one among them.

If you want to secure the transmitted SNMP commands and responses between the NMS and the managed devices, use SNMPv3 version of protocol.

The remote NMS without privilege IP address can't manage the "Gateway 1", since "Gateway 1" allows only the NMS with privilege IP address can manage it via its WAN interface.

4G IIoT LoRa Gateway

SNMP Setting

Go to **Administration > Configure & Manage > SNMP** tab.

The SNMP allows user to configure SNMP relevant setting which includes interface, version, access control and trap receiver.

Enable SNMP

Configuration
⬆️ ✖️

Item	Setting																									
▶ SNMP Enable	<input checked="" type="checkbox"/> LAN <input type="checkbox"/> WAN																									
▶ WAN Interface	All WANs ▾																									
▶ Supported Versions	<input checked="" type="checkbox"/> v1 <input checked="" type="checkbox"/> v2c <input type="checkbox"/> v3																									
▶ SNMP Port	161																									
▶ Limited Remote Access IP	<div style="display: flex; align-items: flex-start;"> <div style="margin-right: 10px;">IP Range ▾</div> <table style="width: 100%; border-collapse: collapse;"> <tr> <td style="width: 20%; border: 1px solid #ccc; height: 20px;"></td> <td style="width: 5%; text-align: center;">-</td> <td style="width: 20%; border: 1px solid #ccc; height: 20px;"></td> <td style="width: 5%;"></td> <td style="width: 50%;"><input type="checkbox"/> Enable</td> </tr> <tr> <td style="border: 1px solid #ccc; height: 20px;"></td> <td style="text-align: center;">-</td> <td style="border: 1px solid #ccc; height: 20px;"></td> <td></td> <td><input type="checkbox"/> Enable</td> </tr> <tr> <td style="border: 1px solid #ccc; height: 20px;"></td> <td style="text-align: center;">-</td> <td style="border: 1px solid #ccc; height: 20px;"></td> <td></td> <td><input type="checkbox"/> Enable</td> </tr> <tr> <td style="border: 1px solid #ccc; height: 20px;"></td> <td style="text-align: center;">-</td> <td style="border: 1px solid #ccc; height: 20px;"></td> <td></td> <td><input type="checkbox"/> Enable</td> </tr> <tr> <td style="border: 1px solid #ccc; height: 20px;"></td> <td style="text-align: center;">-</td> <td style="border: 1px solid #ccc; height: 20px;"></td> <td></td> <td><input type="checkbox"/> Enable</td> </tr> </table> </div>		-			<input type="checkbox"/> Enable		-			<input type="checkbox"/> Enable		-			<input type="checkbox"/> Enable		-			<input type="checkbox"/> Enable		-			<input type="checkbox"/> Enable
	-			<input type="checkbox"/> Enable																						
	-			<input type="checkbox"/> Enable																						
	-			<input type="checkbox"/> Enable																						
	-			<input type="checkbox"/> Enable																						
	-			<input type="checkbox"/> Enable																						

SNMP Item	Value setting	Description
SNMP Enable	1. The boxes are unchecked by default	Select the interface for the SNMP and enable SNMP functions. When Check the LAN box, it will activate SNMP functions and you can access SNMP from LAN side; When Check the WAN box, it will activate SNMP functions and you can access SNMP from WAN side.
WAN Interface	1. A Must filled setting 2. ALL WANs is selected by default	Specify the WAN interface that a remote SNMP host can access to the device. By default, All WANs is selected, and there is no limitation for the WAN inferface.
Supported Versions	1. A Must filled setting 2. The boxes are unchecked by default	Select the version for the SNMP When Check the v1 box. It means you can access SNMP by version 1. When Check the v2c box. It means you can access SNMP by version 2c. When Check the v3 box. It means you can access SNMP by version 3.
SNMP Port	1. String format: any	Specify the SNMP Port .

4G IIoT LoRa Gateway

	port number 2. The default SNMP port is 161 . 3. A Must filled setting	You can fill in any port number. But you must ensure the port number is not to be used. <i>Value Range: 1 ~ 65535.</i>
Limited Remote Access IP	1. String format: any IPv4 address 2. It is an optional item.	Specify the Remote Access IP for WAN and check the box to enable it as well. Select Specific IP Address , and fill in a certain IP address. It means only this IP address can access SNMP from LAN/WAN side. Select IP Range , and fill in a range of IP addresses. It means the IP address within specified range can access SNMP from LAN/WAN side. If you left it as blank, it means any IP address can access SNMP from WAN side.
Save	N/A	Click Save to save the settings
Undo	N/A	Click Undo to cancel the settings

Create/Edit Multiple Community

The SNMP allows you to custom your access control for version 1 and version 2 user. The router supports up to a maximum of 10 community sets.

Multiple Community List Add Delete			
ID	Community	Enable	Actions

When **Add** button is applied, **Multiple Community Rule Configuration** screen will appear.

Multiple Community Rule Configuration	
Item	Setting
Community	Read Only <input type="text"/>
Enable	<input checked="" type="checkbox"/> Enable

Multiple Community Rule Configuration		
Item	Value setting	Description
Community	1. Read Only is selected by default 2. A Must filled setting 3. String format: any text	Specify this version 1 or version v2c user's community that will be allowed Read Only (GET and GETNEXT) or Read-Write (GET, GETNEXT and SET) access respectively. The maximum length of the community is 32.
Enable	1.The box is checked by default	Click Enable to enable this version 1 or version v2c user.
Save	N/A	Click the Save button to save the configuration. But it does not apply to SNMP functions. When you return to the SNMP main page. It will show "Click on save button to apply your changes" remind user to click main page Save button.

4G IIoT LoRa Gateway

Undo	N/A	Click the Undo button to cancel the settings.
Back	N/A	Click the Back button to return to last page.

Create/Edit User Privacy

The SNMP allows you to custom your access control for version 3 user. The router supports up to a maximum of 128 User Privacy sets.

User Privacy List										
ID	User Name	Password	Authentication	Encryption	Privacy Mode	Privacy Key	Authority	OID Filter Prefix	Enable	Actions

When **Add** button is applied, **User Privacy Rule Configuration** screen will appear.

User Privacy Rule Configuration	
Item	Setting
▶ User Name	<input type="text"/>
▶ Password	<input type="password"/>
▶ Authentication	None ▼
▶ Encryption	None ▼
▶ Privacy Mode	noAuthNoPriv ▼
▶ Privacy Key	<input type="password"/>
▶ Authority	Read ▼
▶ OID Filter Prefix	<input type="text" value="1"/>
▶ Enable	<input checked="" type="checkbox"/> Enable

User Privacy Rule Configuration		
Item	Value setting	Description
User Name	1. A Must filled setting 2. String format: any text	Specify the User Name for this version 3 user. Value Range: 1 ~ 32 characters.
Password	1. String format: any text	When your Privacy Mode is authNoPriv or authPriv , you must specify the Password for this version 3 user. Value Range: 8 ~ 64 characters.
Authentication	1. None is selected by default	When your Privacy Mode is authNoPriv or authPriv , you must specify the Authentication types for this version 3 user. Selected the authentication types MD5/ SHA-1 to use.
Encryption	1. None is selected by default	When your Privacy Mode is authPriv , you must specify the Encryption protocols for this version 3 user.

4G IIoT LoRa Gateway

		Selected the encryption protocols DES / AES to use.
Privacy Mode	1. noAuthNoPriv is selected by default	Specify the Privacy Mode for this version 3 user. Selected the noAuthNoPriv . You do not use any authentication types and encryption protocols. Selected the authNoPriv . You must specify the Authentication and Password . Selected the authPriv . You must specify the Authentication, Password, Encryption and Privacy Key.
Privacy Key	1. String format: any text	When your Privacy Mode is authPriv , you must specify the Privacy Key (8 ~ 64 characters) for this version 3 user.
Authority	1. Read is selected by default	Specify this version 3 user's Authority that will be allowed Read Only (GET and GETNEXT) or Read-Write (GET, GETNEXT and SET) access respectively.
OID Filter Prefix	1. The default value is 1 2. A Must filled setting 3. String format: any legal OID	The OID Filter Prefix restricts access for this version 3 user to the sub-tree rooted at the given OID. Value Range: 1 ~2080768.
Enable	1.The box is checked by default	Click Enable to enable this version 3 user.
Save	N/A	Click the Save button to save the configuration. But it does not apply to SNMP functions. When you return to the SNMP main page. It will show "Click on save button to apply your changes" remind user to click main page Save button.
Undo	N/A	Click the Undo button to cancel the settings
Back	N/A	Click the X button to return the last page.

Create/Edit Trap Event Receiver

The SNMP allows you to custom your trap event receiver. The router supports up to a maximum of 4 Trap Event Receiver sets.

Trap Event Receiver List												
ID	Server IP	Server Port	SNMP Version	Community Name	User Name	Password	Privacy Mode	Authentication	Encryption	Privacy Key	Enable	Actions

When **Add** button is applied, **Trap Event Receiver Rule Configuration** screen will appear. The default SNMP Version is v1. The configuration screen will provide the version 1 must filled items.

4G IIoT LoRa Gateway

Trap Event Receiver Rule Configuration	
Item	Setting
▶ Server IP	<input type="text"/> (IP Address/FQDN)
▶ Server Port	<input type="text" value="162"/>
▶ SNMP Version	<input type="text" value="v1"/>
▶ Community Name	<input type="text"/>
▶ Enable	<input checked="" type="checkbox"/> Enable

When you selected v2c, the configuration screen is exactly the same as that of v1, except the version.

When you selected v3, the configuration screen will provide more setting items for the version 3 Trap.

Trap Event Receiver Rule Configuration	
Item	Setting
▶ Server IP	<input type="text"/> (IP Address/FQDN)
▶ Server Port	<input type="text" value="162"/>
▶ SNMP Version	<input type="text" value="v3"/>
▶ Community Name	<input type="text"/>
▶ User Name	<input type="text"/>
▶ Password	<input type="text"/>
▶ Privacy Mode	<input type="text" value="noAuthNoPriv"/>
▶ Authentication	<input type="text" value="None"/>
▶ Encryption	<input type="text" value="None"/>
▶ Privacy Key	<input type="text"/>
▶ Enable	<input checked="" type="checkbox"/> Enable

Trap Event Receiver Rule Configuration		
Item	Value setting	Description
Server IP	<ol style="list-style-type: none"> 1. A Must filled setting 2. String format: any IPv4 address or FQDN 	Specify the trap Server IP or FQDN . The DUT will send trap to the server IP/FQDN.
Server Port	<ol style="list-style-type: none"> 1. String format: any port number 2. The default SNMP trap port is 162 3. A Must filled setting 	Specify the trap Server Port . You can fill in any port number. But you must ensure the port number is not to be used. <i>Value Range: 1 ~ 65535.</i>
SNMP Version	<ol style="list-style-type: none"> 1. v1 is selected by 	Select the version for the trap

4G IIoT LoRa Gateway

	default	<p>Selected the v1. The configuration screen will provide the version 1 must filled items.</p> <p>Selected the v2c. The configuration screen will provide the version 2c must filled items.</p> <p>Selected the v3. The configuration screen will provide the version 3 must filled items.</p>
Community Name	<ol style="list-style-type: none"> 1. A v1 and v2c Must filled setting 2. String format: any text 	<p>Specify the Community Name for this version 1 or version v2c trap. <i>Value Range: 1 ~ 32 characters.</i></p>
User Name	<ol style="list-style-type: none"> 1. A v3 Must filled setting 2. String format: any text 	<p>Specify the User Name for this version 3 trap. <i>Value Range: 1 ~ 32 characters.</i></p>
Password	<ol style="list-style-type: none"> 1. A v3 Must filled setting 2. String format: any text 	<p>When your Privacy Mode is authNoPriv or authPriv, you must specify the Password for this version 3 trap. <i>Value Range: 8 ~ 64 characters.</i></p>
Privacy Mode	<ol style="list-style-type: none"> 1. A v3 Must filled setting 2. noAuthNoPriv is selected by default 	<p>Specify the Privacy Mode for this version 3 trap. Selected the noAuthNoPriv. You do not use any authentication types and encryption protocols. Selected the authNoPriv. You must specify the Authentication and Password. Selected the authPriv. You must specify the Authentication, Password, Encryption and Privacy Key.</p>
Authentication	<ol style="list-style-type: none"> 1. A v3 Must filled setting 2. None is selected by default 	<p>When your Privacy Mode is authNoPriv or authPriv, you must specify the Authentication types for this version 3 trap. Selected the authentication types MD5/ SHA-1 to use.</p>
Encryption	<ol style="list-style-type: none"> 1. A v3 Must filled setting 2. None is selected by default 	<p>When your Privacy Mode is authPriv, you must specify the Encryption protocols for this version 3 trap. Selected the encryption protocols DES / AES to use.</p>
Privacy Key	<ol style="list-style-type: none"> 1. A v3 Must filled setting 2. String format: any text 	<p>When your Privacy Mode is authPriv, you must specify the Privacy Key (8 ~ 64 characters) for this version 3 trap.</p>
Enable	1.The box is checked by default	Click Enable to enable this trap receiver.
Save	N/A	Click the Save button to save the configuration. But it does not apply to SNMP functions. When you return to the SNMP main page. It will show “Click on save button to apply your changes” remind user to click main page Save button.
Undo	N/A	Click the Undo button to cancel the settings.
Back	N/A	Click the X button to return to last page.

4G IIoT LoRa Gateway

Specify SNMP MIB-2 System

If required, you can also specify the required information the the MIB-2 System.

SNMP MIB-2 System	
Item	Setting
▶ sysContact	<input type="text"/>
▶ sysLocation	<input type="text"/>

Item	Value setting	Description
sysContact	1. An Optional filled setting 2. String format: any text	Specify the contact information forMIB-2 system. <i>Value Range:</i> 0 ~ 64 characters.
sysLocation	1. An Optional filled setting 2. String format: any text	Specify the location information forMIB-2 system. <i>Value Range:</i> 0 ~ 64 characters.

Edit SNMP Options

If you use some particular private MIB, you must fill the enterprise name, number and OID.

Options	
Item	Setting
▶ Enterprise Name	<input type="text" value="Default"/>
▶ Enterprise Number	<input type="text" value="12823"/>
▶ Enterprise OID	1.3.6.1.4.1. <input type="text" value="12823.4.4.9"/>

Item	Value setting	Description
Enterprise Name	1. The default value is Default 2. A Must filled setting 3. String format: any text	Specify the Enterprise Name for the particular private MIB. <i>Value Range:</i> 1 ~ 10 characters, and only string with A~Z, a~z, 0~9, '-', '_'.
Enterprise Number	The default value is 12823 (Default Enterprise	Specify the Enterprise Number for the particular private MIB. <i>Value Range:</i> 1 ~2080768.

4G IIoT LoRa Gateway

	Number) 2. A Must filled setting 3. String format: any number	
Enterprise OID	1. The default value is 1.3.6.1.4.1.12823.4.4.9 (Default Enterprise OID) 2. A Must filled setting 3. String format: any legal OID	Specify the Enterprise OID for the particular private MIB. The range of the each OID number is 1-2080768. The maximum length of the enterprise OID is 31. The seventh number must be identical with the enterprise number.
Save	N/A	Click the Save button to save the configuration and apply your changes to SNMP functions.
Undo	N/A	Click the Undo button to cancel the settings.

4G IIoT LoRa Gateway

6.1.4 Telnet & SSH

A command-line interface (CLI), also known as command-line user interface, and console user interface are means of interacting with a computer program where the user (or client) issues commands to the program in the form of successive lines of text (command lines). The interface is usually implemented with a command line shell, which is a program that accepts commands as text input and converts commands to appropriate operating system functions. Programs with command-line interfaces are generally easier to automate via scripting. The device supports both Telnet and SSH (Secure Shell) CLI with default service port 23 and 22, respectively.

Telnet & SSH Scenario

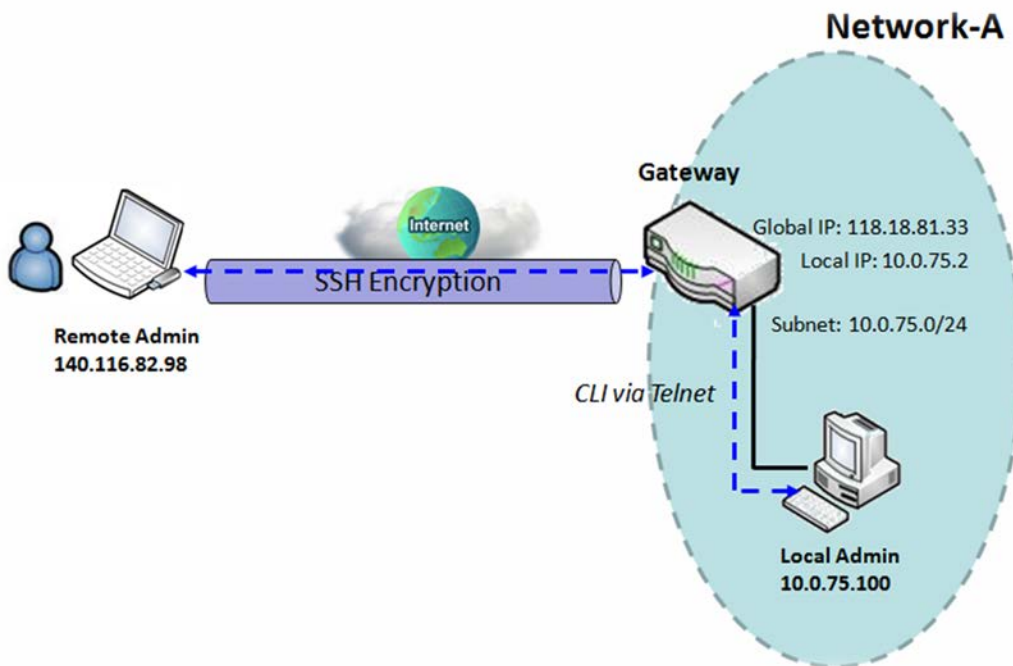

Scenario Application Timing

When the administrator of the gateway wants to manage it from remote site in the Intranet or Internet, he may use "Telnet with CLI" function to do that by using "Telnet" or "SSH" utility.

Scenario Description

The Local Admin or the Remote Admin can manage the Gateway by using "Telnet" or "SSH" utility with privileged user name and password.

The data packets between the Local Admin and the Gateway or between the Remote Admin and the Gateway can be plain texts or encrypted texts. Suggest they are plain texts in the Intranet for Local Admin to use "Telnet" utility, and encrypted texts in the Internet for Remote Admin to use "SSH" utility.

4G IIoT LoRa Gateway

Parameter Setup Example

Following table lists the parameter configuration as an example for the Gateway in above diagram with "Telnet with CLI" enabling at LAN and WAN interfaces.

Use default value for those parameters that are not mentioned in the table.

Configuration Path	[Telnet & SSH]-[Configuration]
Telnet	LAN: <input checked="" type="checkbox"/> Enable WAN: <input type="checkbox"/> Enable Service Port: 23
SSH	LAN: <input checked="" type="checkbox"/> Enable WAN: <input checked="" type="checkbox"/> Enable Service Port: 22

Scenario Operation Procedure

In above diagram, "Local Admin" or "Remote Admin" can manage the "Gateway" in the Intranet or Internet. The "Gateway" is the gateway of Network-A, and the subnet of its Intranet is 10.0.75.0/24. It has the IP address of 10.0.75.2 for LAN interface and 118.18.81.33 for WAN-1 interface. It serves as a NAT gateway.

The "Local Admin" in the Intranet uses "Telnet" utility with privileged account to login the Gateway.

Or the "Remote Admin" in the Internet uses "SSH" utility with privileged account to login the Gateway.

The administrator of the gateway can control the device as like he is in front of the gateway.

4G IIoT LoRa Gateway

Telnet & SSH Setting

Go to **Administration > Configure & Manage > Telnet & SSH** tab.

The Telnet & SSH setting allows administrator to access this device through the traditional Telnet or SSH Telnet program. Before you can telnet (login) to the device, please configure the related settings and password with care. The password management part allows you to set root password for logging telnet and SSH.

Configuration	
Item	Setting
▶ Telnet	LAN <input checked="" type="checkbox"/> Enable WAN <input type="checkbox"/> Enable (WAN-1 <input checked="" type="checkbox"/> WAN-4 <input type="checkbox"/>) <input type="text"/> Service Port <input type="text" value="23"/>
▶ SSH	LAN <input checked="" type="checkbox"/> Enable WAN <input type="checkbox"/> Enable (WAN-1 <input checked="" type="checkbox"/> WAN-4 <input type="checkbox"/>) <input type="text"/> Service Port <input type="text" value="22"/>

Configuration		
Item	Value setting	Description
Telnet	1. The LAN Enable box is checked by default. 2. By default Service Port is 23.	Check the Enable box to activate the Telnet function for connecting from LAN or WAN interfaces. You can set which number of Service Port you want to provide for the corresponding service. Value Range: 1 ~65535.
SSH	3. The LAN Enable box is checked by default. 4. By default Service Port is 22.	Check the Enable box to activate the SSH Telnet function for connecting from LAN or WAN interfaces. You can set which number of Service Port you want to provide for the corresponding service. Value Range: 1 ~65535.
Save	N/A	Click Save to save the settings
Undo	N/A	Click Undo to cancel the settings

4G IIoT LoRa Gateway

Password Management
Save
Undo
▲ ✕

Item	Setting
▶ root	Old Password : <input style="width: 150px;" type="text"/> New Password : <input style="width: 150px;" type="text"/> New Password Confirmation : <input style="width: 150px;" type="text"/>

Configuration		
Item	Value setting	Description
root	1. String: any text but no blank character 2. The default password for telnet is 'wirelessm2m'.	Type old password and specify new password to change root password. Note_1: You are highly recommended to change the default telnet password with yours before the device is deployed. Note_2: If you have trouble for the default password for previous FW version, please check the corresponding User Manual to get the correct one.
Save	N/A	Click Save to save the settings
Undo	N/A	Click Undo to cancel the settings

4G IIoT LoRa Gateway

6.2 System Operation

System Operation allows the network administrator to manage system, settings such as web-based utility access password change, system information, system time, system log, firmware/configuration backup & restore, and reset & reboot.

6.2.1 Password & MMI

Go to **Administration > System Operation > Password & MMI** tab.

Setup Host Name

Host Name screen allows network administrator to setup / change the host name of the gateway. Click the **Modify** button and provide the new username setting.

Host Name	
Item	Setting
▶ Host Name	<input type="text"/>

Username Configuration		
Item	Value setting	Description
Host Name	1. An Optional setting 2. It is blanked by default	Enter the host name of the gateway.
Save	N/A	Click Save button to save the settings
Undo	N/A	Click Undo button to cancel the settings

Change UserName

Username screen allows network administrator to change the web-based MMI login account to access gateway. Click the **Modify** button and provide the new username setting.



Username	
Item	Setting
▶ Username	admin <input type="button" value="Modify"/>
▶ New Username	<input type="text"/>
▶ Password	<input type="text"/>

4G IIoT LoRa Gateway

Username Configuration		
Item	Value setting	Description
Username	1. The default Username for web-based MMI is 'admin'.	Display the current MMI login account (Username).
New Username	String: any text	Enter new Username to replace the current setting.
Password	String: any text	Enter current password to verify if you have the permission to change the username setting.
Save	N/A	Click Save button to save the settings
Undo	N/A	Click Undo button to cancel the settings

Change Password

Change password screen allows network administrator to change the web-based MMI login password to access gateway.

 Password  

Item	Setting
▶ Old Password	<input type="password"/>
▶ New Password	<input type="password"/>
▶ New Password Confirmation	<input type="password"/>

Password Configuration		
Item	Value setting	Description
Old Password	1. String: any text 2. The default password for web-based MMI is 'admin'.	Enter the current password to enable you unlock to change password.
New Password	String: any text	Enter new password
New Password Confirmation	String: any text	Enter new password again to confirm
Save	N/A	Click Save button to save the settings
Undo	N/A	Click Undo button to cancel the settings

Change MMI Setting for Accessing

This is the gateway's web-based MMI access which allows administrator to access the gateway for management. The gateway's web-based MMI will automatically logout when the idle time has elapsed. The

4G IIoT LoRa Gateway

setting allows administrator to enable automatic logout and set the logout idle time. When the login timeout is disabled, the system won't logout the administrator automatically.

Item	Setting
▶ Login	Password-Guessing Attack & MAX: <input type="text" value="3"/> (times)
▶ Login Timeout	<input checked="" type="checkbox"/> Enable <input type="text" value="300"/> (seconds)
▶ GUI Access Protocol	<input type="text" value="http/https"/>
▶ HTTPs Certificate Setup	<input checked="" type="radio"/> default <input type="radio"/> Select from Certificate List Certificate: <input type="text" value="TrustedCert0"/> Key: <input type="text" value="TrustedKey0"/>
▶ HTTP Compression	<input checked="" type="checkbox"/> gzip <input type="checkbox"/> deflate
▶ HTTP Binding	<input checked="" type="checkbox"/> DHCP 1
▶ System Boot Mode	<input type="text" value="Normal Mode"/>

MMI Configuration		
Item	Value setting	Description
Login	3 times is set by default	Enter the login trial counting value. Value Range: 3 ~ 10. If someone tried to login the web GUI with incorrect password for more than the counting value, an warning message " Already reaching maximum Password-Guessing times, please wait a few seconds! " will be displayed and ignore the following login trials.
Login Timeout	The Enable box is checked, and 300 is set by default.	Check the Enable box to activate the auto logout function, and specify the maximum idle time as well. Value Range: 30 ~ 65535.
GUI Access Protocol	http/https is selected by default.	Select the protocol that will be used for GUI access. It can be http/https , http only , or https only .
HTTPs Certificate Setup	The default box is selected by default	If the https Access Protocol is selected, the HTTPs Certificate Setup option will be available for further configuration. You can leave it as default or select a expected certificate and key from the drop down list. Refer to Object Definition > Certificate Section for the Certificate configuration.
HTTP Compression	The box is unchecked by default.	Check the box (gzip , or deflate) if any compression method is preferred.
HTTP Binding	1. An Optional setting 2. DHCP-1 is checked by default	Select the DHCP Server to bind with http access.
System Boot Mode	Normal Mode is selected	Select the system boot mode that will be adopted to boot up the device.

4G IIoT LoRa Gateway

by default.

Normal Mode: It takes longer boot up time, with complete firmware image check during the device booting.

Fast Mode: It takes shorter boot up time, without checking the firmware image during the device booting.

Quick Mode: It takes the shortest boot up time, without checking the firmware image and creating the internal database for User/Group/Captive Portal functions.

Note: Use **Quick Mode** with care, once selected, the User/Group/Captive Portal function will become non-functional.

Save	N/A	Click Save button to save the settings
Undo	N/A	Click Undo button to cancel the settings

4G IIoT LoRa Gateway

6.2.2 System Information

System Information screen gives network administrator a quick look up on the device information for the purchased gateway.

Go to **Administration > System Operation > System Information** tab.

System Information	
Item	Setting
▶ Model Name	VHG87BAM_0T001
▶ Device Serial Number	
▶ Kernel Version	2.6.36
▶ FW Version	0000Y90.J31_e32.BETA_04021700
▶ System Time	Thu, 18 Apr 2019 16:18:16 +0800
▶ Device Up-Time	15day 22hr 30min 35sec

System Information		
Item	Value Setting	Description
Model Name	N/A	It displays the model name of this product.
Device Serial Number	N/A	It displays the serial number of this product.
Kernel Version	N/A	It displays the Linux kernel version of the product
FW Version	N/A	It displays the firmware version of the product
Memory Usage	N/A	It displays the percentage of device memory utilization.
System Time	N/A	It displays the current system time that you browsed this web page.
Device Up-Time	N/A	It displays the statistics for the device up-time since last boot up.
Refresh	N/A	Click the Refresh button to update the system Information immediately.

4G IIoT LoRa Gateway

6.2.3 System Time

The gateway provides manually setup and auto-synchronized approaches for the administrator to setup the system time for the gateway. The time supported synchronization methods can be Time Server, Manual, PC, Cellular Module, or GPS Signal. Select the method first, and then configure rest settings.

Instead of manually configuring the system time for the gateway, there are two simple and quick solutions for you to set the correct time information and set it as the system time for the gateway.

The first one is “Sync with Timer Server”. Based on your selection of time zone and time server in above time information configuration window, system will communicate with time server by NTP Protocol to get system date and time after you click on the **Synchronize immediately** button.

The second one is “Sync with my PC”. Select the method and the system will synchronize its date and time to the time of the administration PC.

Go to **Administration > System Operation > System Time** tab.

Synchronize with Time Server

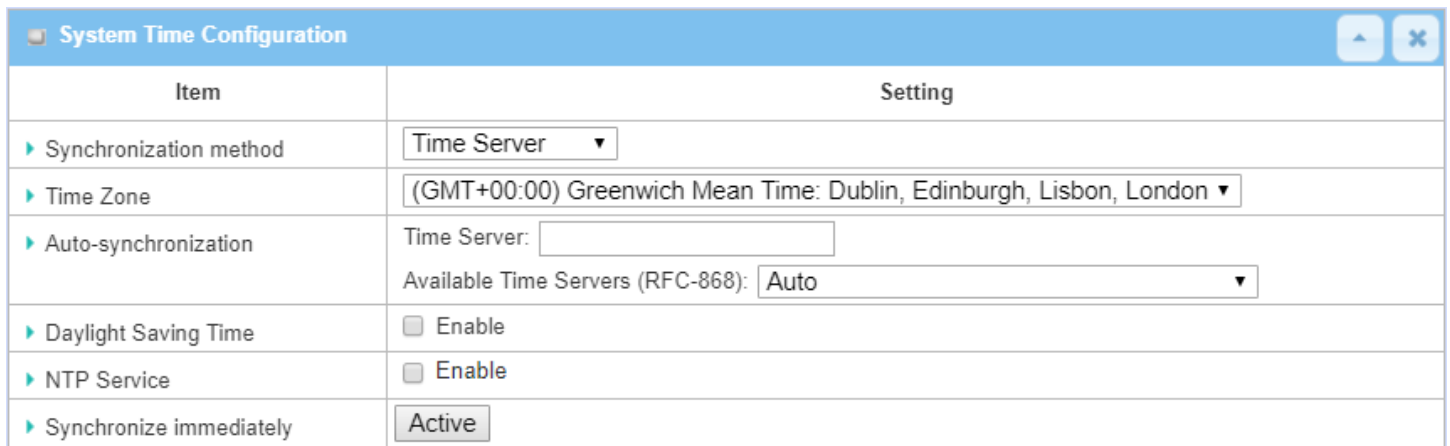

The screenshot shows a 'System Time Configuration' window with the following settings:

Item	Setting
Synchronization method	Time Server
Time Zone	(GMT+00:00) Greenwich Mean Time: Dublin, Edinburgh, Lisbon, London
Auto-synchronization	Time Server: [] Available Time Servers (RFC-868): Auto
Daylight Saving Time	<input type="checkbox"/> Enable
NTP Service	<input type="checkbox"/> Enable
Synchronize immediately	Active

System Time Information		
Item	Value Setting	Description
Synchronization method	1. A Must-filled item. 2. Time Server is selected by default.	Select the Time Server as the synchronization method for the system time.
Time Zone	1. A Must-filled item. 2. GMT+00 :00 is selected by default.	Select a time zone where this device locates.
Auto-synchronization	1. A Must-filled item. 2. Auto is selected by	Enter the IP or FQDN for the NTP time server you expected, or leave it as auto mode so that the available server will be used for time synchronization one by

4G IIoT LoRa Gateway

	default.	one.
Daylight Saving Time	1. It is an optional item. 2. Un-checked by default	Check the Enable button to activate the daylight saving function. When you enabled this function, you have to specify the start date and end date for the daylight saving time duration.
NTP Service	1. It is an optional item. 2. Un-checked by default	Check the Enable button to activate the NTP Service function. When you enabled this function, the gateway can provide NTP server service for its local connected devices.
Synchronize immediately	N/A	Click the Active button to synchronize the system time with specified time server immediately.
Save	N/A	Click the Save button to save the settings.
Refresh	N/A	Click the Refresh button to update the system time immediately.

Note: Remember to select a correct time zone for the device, otherwise, you will just get the UTC (Coordinated Universal Time) time, not the local time for the device.

Synchronize with Manually Setting

System Time Configuration
▲ ✕

Item	Setting
▶ Synchronization method	Manual ▼
▶ Time Zone	(GMT+00:00) Greenwich Mean Time: Dublin, Edinburgh, Lisbon, London ▼
▶ Daylight Saving Time	<input type="checkbox"/> Enable
▶ Set Date & Time Manually	2019 ▼ / April ▼ / 18 ▼ (Year/Month/Day)
	16 ▼ : 24 ▼ : 27 ▼ (Hour:Minute:Second)
▶ NTP Service	<input type="checkbox"/> Enable

System Time Information		
Item	Value Setting	Description
Synchronization method	1. A Must-filled item. 2. Time Server is selected by default.	Select the Manual as the synchronization method for the system time. It means administrator has to set the Date & Time manually.
Time Zone	1. A Must-filled item. 2. GMT+00 :00 is selected by default.	Select a time zone where this device locates.
Daylight Saving Time	1. It is an optional item. 2. Un-checked by default	Check the Enable button to activate the daylight saving function. When you enabled this function, you have to specify the start date and end date for the daylight saving time duration.
Set Date & Time Manually	1. It is an optional item.	Manually set the date (Year/Month/Day) and time (Hour:Minute:Second) as the system time.
NTP Service	1. It is an optional item.	Check the Enable button to activate the NTP Service function.

4G IIoT LoRa Gateway

	2. Un-checked by default	When you enabled this function, the gateway can provide NTP server service for its local connected devices.
Save	N/A	Click the Save button to save the settings.

Synchronize with PC

System Time Configuration
⬆️ ✖️

Item	Setting
▶ Synchronization method	<input style="width: 80%;" type="text" value="PC"/>
▶ NTP Service	<input type="checkbox"/> Enable
▶ Synchronize immediately	<input type="button" value="Active"/>

System Time Information		
Item	Value Setting	Description
Synchronization method	1. A Must-filled item. 2. Time Server is selected by default.	Select PC as the synchronization method for the system time to let system synchronize its date and time to the time of the administration PC.
NTP Service	1. It is an optional item. 2. Un-checked by default	Check the Enable button to activate the NTP Service function. When you enabled this function, the gateway can provide NTP server service for its local connected devices.
Synchronize immediately	N/A	Click the Active button to synchronize the system time with specified time server immediately.
Save	N/A	Click the Save button to save the settings.
Refresh	N/A	Click the Refresh button to update the system time immediately.

4G IIoT LoRa Gateway

Synchronize with Cellular Time Service

System Time Configuration	
Item	Setting
▶ Synchronization method	Cellular Module ▾
▶ Time Zone	(GMT+00:00) Greenwich Mean Time: Dublin, Edinburgh, Lisbon, London ▾
▶ NTP Service	<input type="checkbox"/> Enable
▶ Synchronize immediately	Active

System Time Information		
Item	Value Setting	Description
Synchronization method	<ol style="list-style-type: none">1. A Must-filled item.2. Time Server is selected by default.	Select Cellular Module as the synchronization method for the system time to let system synchronize its date and time to the time provided from the connected mobile ISP. Note: this option is only available for the product with Cellular WAN interface.
Time Zone	<ol style="list-style-type: none">1. A Must-filled item.2. GMT+00 :00 is selected by default.	Select a time zone where this device locates.
NTP Service	<ol style="list-style-type: none">1. It is an optional item.2. Un-checked by default	Check the Enable button to activate the NTP Service function. When you enabled this function, the gateway can provide NTP server service for its local connected devices.
Synchronize immediately	N/A	Click the Active button to synchronize the system time with specified time server immediately.
Save	N/A	Click the Save button to save the settings.
Refresh	N/A	Click the Refresh button to update the system time immediately.

4G IIoT LoRa Gateway

Synchronize with GPS Time Service

System Time Configuration	
Item	Setting
▶ Synchronization method	GPS Signal ▼
▶ Time Zone	(GMT+00:00) Greenwich Mean Time: Dublin, Edinburgh, Lisbon, London ▼
▶ NTP Service	<input type="checkbox"/> Enable
▶ Synchronize immediately	Active

System Time Information		
Item	Value Setting	Description
Synchronization method	<ol style="list-style-type: none">1. A Must-filled item.2. Time Server is selected by default.	Select GPS Signal as the synchronization method for the system time to let system synchronize its date and time to the time provided from the GNSS service. Note: this option is only available for the product with GNSS interface.
Time Zone	<ol style="list-style-type: none">1. A Must-filled item.2. GMT+00 :00 is selected by default.	Select a time zone where this device locates.
NTP Service	<ol style="list-style-type: none">1. It is an optional item.2. Un-checked by default	Check the Enable button to activate the NTP Service function. When you enabled this function, the gateway can provide NTP server service for its local connected devices.
Synchronize immediately	N/A	Click the Active button to synchronize the system time with specified time server immediately.
Save	N/A	Click the Save button to save the settings.
Refresh	N/A	Click the Refresh button to update the system time immediately.

4G IIoT LoRa Gateway

6.2.4 System Log

System Log screen contains various event log tools facilitating network administrator to perform local event logging and remote reporting.

Go to **Administration > System Operation > System Log** tab.

Item	Setting
▶ Web Log Type Category	<input checked="" type="checkbox"/> System <input checked="" type="checkbox"/> Attacks <input checked="" type="checkbox"/> Drop <input checked="" type="checkbox"/> Login message <input type="checkbox"/> Debug
▶ Email Alert	<input type="checkbox"/> Enable Server: --- Option --- <input type="button" value="Add Object"/> E-mail Addresses: <input type="text"/> Subject: <input type="text"/> Log type Category: <input type="checkbox"/> System <input type="checkbox"/> Attacks <input type="checkbox"/> Drop <input type="checkbox"/> Login message <input type="checkbox"/> Debug
▶ Syslog	<input type="checkbox"/> Enable Server: --- Option --- <input type="button" value="Add Object"/> Log type Category: <input type="checkbox"/> System <input type="checkbox"/> Attacks <input type="checkbox"/> Drop <input type="checkbox"/> Login message <input type="checkbox"/> Debug
▶ Log to Storage	<input checked="" type="checkbox"/> Enable Select Device: Internal <input type="button" value="v"/> Log file name: syslog Split file: <input type="checkbox"/> Enable Size: 200 <input type="button" value="KB v"/> Interval: <input type="checkbox"/> Enable 1440 (1 ~ 10080 Minutes) Max Records: 3000 (5~10000) <input type="button" value="Download log file"/> <input type="button" value="clear logs"/> Log type Category: <input checked="" type="checkbox"/> System <input checked="" type="checkbox"/> Attacks <input checked="" type="checkbox"/> Drop <input checked="" type="checkbox"/> Login message <input checked="" type="checkbox"/> Debug

View & Email Log History

View button is provided for network administrator to view log history on the gateway. **Email Now** button enables administrator to send instant Email for analysis.

View & Email Log History		
Item	Value setting	Description
View button	N/A	Click the View button to view Log History in Web Log List Window.
Email Now button	N/A	Click the Email Now button to send Log History via Email instantly.

4G IIoT LoRa Gateway

Web Log List	
Previous	Next
First	Last
Download	Clear
Time	Log
Apr 1 06:01:36	dnsmasq-dhcp[6016]: Ignoring domain amit.com.tw for DHCP host name NB-msnb
Apr 1 06:08:31	dnsmasq-dhcp[6016]: Ignoring domain amit.com.tw for DHCP host name NB-msnb
Apr 1 06:15:30	dnsmasq-dhcp[6016]: Ignoring domain amit.com.tw for DHCP host name NB-msnb
Apr 1 06:22:06	dnsmasq-dhcp[6016]: Ignoring domain amit.com.tw for DHCP host name NB-msnb
Apr 1 06:28:42	dnsmasq-dhcp[6016]: Ignoring domain amit.com.tw for DHCP host name NB-msnb
Apr 1 06:35:42	dnsmasq-dhcp[6016]: Ignoring domain amit.com.tw for DHCP host name NB-msnb
Apr 1 06:42:20	dnsmasq-dhcp[6016]: Ignoring domain amit.com.tw for DHCP host name NB-msnb

Web Log List Window		
Item	Value Setting	Description
Time column	N/A	It displays event time stamps
Log column	N/A	It displays Log messages

Web Log List Button Description		
Item	Value setting	Description
Previous	N/A	Click the Previous button to move to the previous page.
Next	N/A	Click the Next button to move to the next page.
First	N/A	Click the First button to jump to the first page.
Last	N/A	Click the Last button to jump to the last page.
Download	N/A	Click the Download button to download log to your PC in tar file format.
Clear	N/A	Click the Clear button to clear all log.
Back	N/A	Click the Back button to return to the previous page.

Web Log Type Category

Web Log Type Category screen allows network administrator to select the type of events to log and be displayed in the Web Log List Window as described in the previous section. Click on the View button to view Log History in the Web Log List window.

Web Log Type Category	<input checked="" type="checkbox"/> System	<input checked="" type="checkbox"/> Attacks	<input checked="" type="checkbox"/> Drop	<input checked="" type="checkbox"/> Login message	<input type="checkbox"/> Debug
-----------------------	--	---	--	---	--------------------------------

Web Log Type Category Setting Window		
Item	Value Setting	Description
System	Checked by default	Check to log system events and to display in the Web Log List window.
Attacks	Checked by default	Check to log attack events and to display in the Web Log List window.
Drop	Checked by default	Check to log packet drop events and to display in the Web Log List window.
Login message	Checked by default	Check to log system login events and to display in the Web Log List window.

4G IIoT LoRa Gateway

Debug	Un-checked by default	Check to log debug events and to display in the Web Log List window.
-------	-----------------------	--

Email Alert

Email Alert screen allows network administrator to select the type of event to log and be sent to the destined Email account.

▶ Email Alert

Enable

Server: --- Option --- ▼ Add Object

E-mail Addresses:

Subject:

Log type Category: System Attacks Drop Login message Debug

Email Alert Setting Window		
Item	Value Setting	Description
Enable	Un-checked by default	Check Enable box to enable sending event log messages to destined Email account defined in the E-mail Addresses blank space.
Server	N/A	Select one email server from the Server dropdown box to send Email. If none has been available, click the Add Object button to create an outgoing Email server. You may also add an outgoing Email server from Object Definition > External Server > External Server tab.
E-mail address	String : email format	Enter the recipient's Email address. Separate Email addresses with comma ',' or semicolon ';' Enter the Email address in the format of 'myemail@domain.com'
Subject	String : any text	Enter an Email subject that is easy for you to identify on the Email client.
Log type category	Default unchecked	Select the type of events to log and be sent to the designated Email account. Available events are System, Attacks, Drop, Login message, and Debug.

4G IIoT LoRa Gateway

Syslogd

Syslogd screen allows network administrator to select the type of event to log and be sent to the designated Syslog server.

▶ Syslogd
 Enable Server: --- Option --- Add Object
 Log type Category: System Attacks Drop Login message Debug

Syslogd Setting Window		
Item	Value Setting	Description
Enable	Un-checked by default	Check Enable box to activate the Syslogd function, and send event logs to a syslog server
Server	N/A	Select one syslog server from the Server dropdown box to send event log to. If none has been available, click the Add Object button to create a system log server. You may also add an system log server from the Object Definition > External Server > External Server tab.
Log type category	Un-checked by default	Select the type of event to log and be sent to the destined syslog server. Available events are System, Attacks, Drop, Login message, and Debug.

Log to Storage

Log to Storage screen allows network administrator to select the type of events to log and be stored at an internal or an external storage.

▶ Log to Storage
 Enable
 Select Device: Internal ▾
 Log file name: syslog
 Split file: Enable Size: 200 KB ▾
 Interval: Enable 1440 (1 ~ 10080 Minutes)
 Max Records: 3000 (5~10000)
Download log file clear logs
 Log type Category: System Attacks Drop Login message Debug

Log to Storage Setting Window		
Item	Value Setting	Description
Enable	Un-checked by default	Check to enable sending log to storage.
Select Device	Internal is selected by default	Select internal or external storage.
Log file name	Un-checked by default	Enter log file name to save logs in designated storage.
Split file Enable	Un-checked by default	Check enable box to split file whenever log file reaching the specified limit.
Split file Size	200 KB is set by default	Enter the file size limit for each split log file. <i>Value Range: 10 ~ 1000.</i>
Interval Enable	Un-checked by default	Check enable box to enable the log interval setting.
Log Interval	1440 is set by default	Enter the log interval setting. <i>Value Range: 1 ~ 10080 Minute.</i>
Max Records	3000 is set by default	Enter the maximum number of records to be stored in the log storage. <i>Value Range: 5 ~ 10000.</i>
Log type category	Un-checked by default	Check which type of logs to send: System, Attacks, Drop, Login message, Debug

4G IIoT LoRa Gateway

Log to Storage Button Description		
Item	Value setting	Description
Download log file	N/A	Click the Download log file button to download log files to a log.tar file.
Clear Logs	N/A	Click the Clear logs button to delete the log files from the storage.

4G IIoT LoRa Gateway

6.2.5 Backup & Restore

In the Backup & Restore window, you can upgrade the device firmware when new firmware is available and also backup / restore the device configuration.

In addition to the factory default settings, you can also customize a special configuration setting as a customized default value. With this customized default value, you can reset the device to the expected default setting if needed.

Go to **Administration > System Operation > Backup & Restore** tab.

FW Backup & Restore	
Item	Setting
▶ FW Upgrade	Via Web UI ▼ FW Upgrade
▶ Backup Configuration Settings	Download ▼ Via Web UI
▶ Auto Restore Configuration	<input type="checkbox"/> Enable Save Conf. Clean Conf. Conf. Info.
▶ Self-defined Logo	Download ▼ Via Web UI Reset
▶ Self-defined CSS	Edit : Download ▼ Via Web UI Reset

FW Backup & Restore		
Item	Value Setting	Description
FW Upgrade	Via Web UI is selected by default	If new firmware is available, click the FW Upgrade button to upgrade the device firmware via Web UI , or Via Storage . After clicking on the “FW Upgrade” command button, you need to specify the file name of new firmware by using “Browse” button, and then click “Upgrade” button to start the FW upgrading process on this device. If you want to upgrade a firmware which is from GPL policy, please check “Accept unofficial firmware”
Backup Configuration Settings	Download is selected by default	You can backup or restore the device configuration settings by clicking the Via Web UI button. Download: for backup the device configuration to a config.bin file. Upload: for restore a designated configuration file to the device. Via Web UI: to retrieve the configuration file via Web GUI.
Auto Restore Configuration	The Enable box is unchecked by default	Click the Enable button to activate the customized default setting function. Once the function is activated, you can save the expected setting as a customized default setting by clicking the Save Conf. button, or clicking the Clean Conf. button to erase the stored customized configuration.

4G IIoT LoRa Gateway

6.2.6 Reboot & Reset

For some special reason or situation, you may need to reboot the gateway or reset the device configuration to its default value. In addition to perform these operations through the Power ON/OFF, or pressing the reset button on the device panel, you can do it through the web GUI too.

Go to **Administration > System Operation > Reboot & Reset** tab.

In the Reboot & Reset window, you can reboot this device by clicking the “Reboot” button, and reset this device to default settings by clicking the “Reset” button.

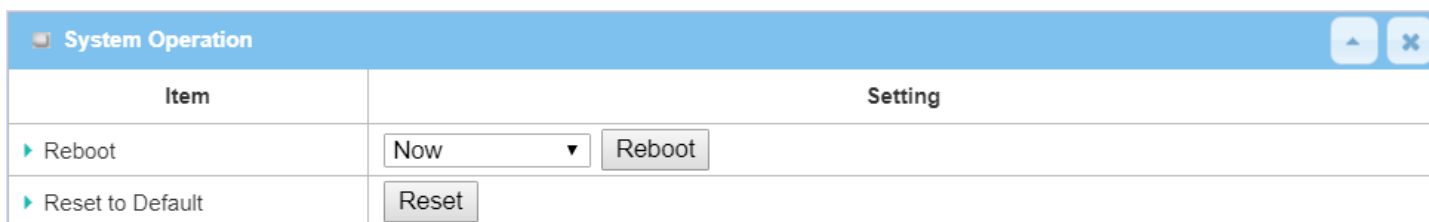

System Operation Window		
Item	Value Setting	Description
Reboot	Now is selected by default	Click the Reboot button to reboot the gateway immediately or on a pre-defined time schedule. Now: Reboot immediately Time Schedule: Select a pre-defined auto-reboot time schedule rule to reboot the auto device on a designated tim. To define a time schedule rule, go to Object Definition > Scheduling > Configuration tab.
Reset to Default	N/A	Click the Reset button to reset the device configuration to its default value.

4G IIoT LoRa Gateway

6.3 FTP

The File Transfer Protocol (FTP) is a standard network protocol used to transfer computer files between a client and server on a computer network. FTP is built on a client-server model architecture and uses separate control and data connections between the client and the server. FTP users may authenticate themselves with a clear-text sign-in protocol, normally in the form of a username and password, but can connect anonymously if the server is configured to allow it.

For secure transmission that protects the username and password, and encrypts the content, FTP is often secured with SSL/TLS (FTPS). Besides, SSH File Transfer Protocol (SFTP) is sometimes also used instead, but is technologically different.

This gateway embedded FTP / SFTP server for administrator to download the log files to his computer or database. In the following two sections, you can configure the FTP server and create the user accounts that can login to the server. After login to the FTP server, you can browse the log directory and have the permission to download the stored log files and delete the files you have downloaded to make more storage space for further data logs.

The available log files can be system logs (refer to Administration > System Operation > System Log), Network Packets (refer to Administrator > Diagnostic > Packet Analyzer), Data Log (refer to Field Communication > Data Logging > Log File Management), and GNSS Log (refer to Service > Location Tracking > GNSS). With proper configuration for the various log functions that supported on your purchased product, you can download the log via FTP / SFTP connections.

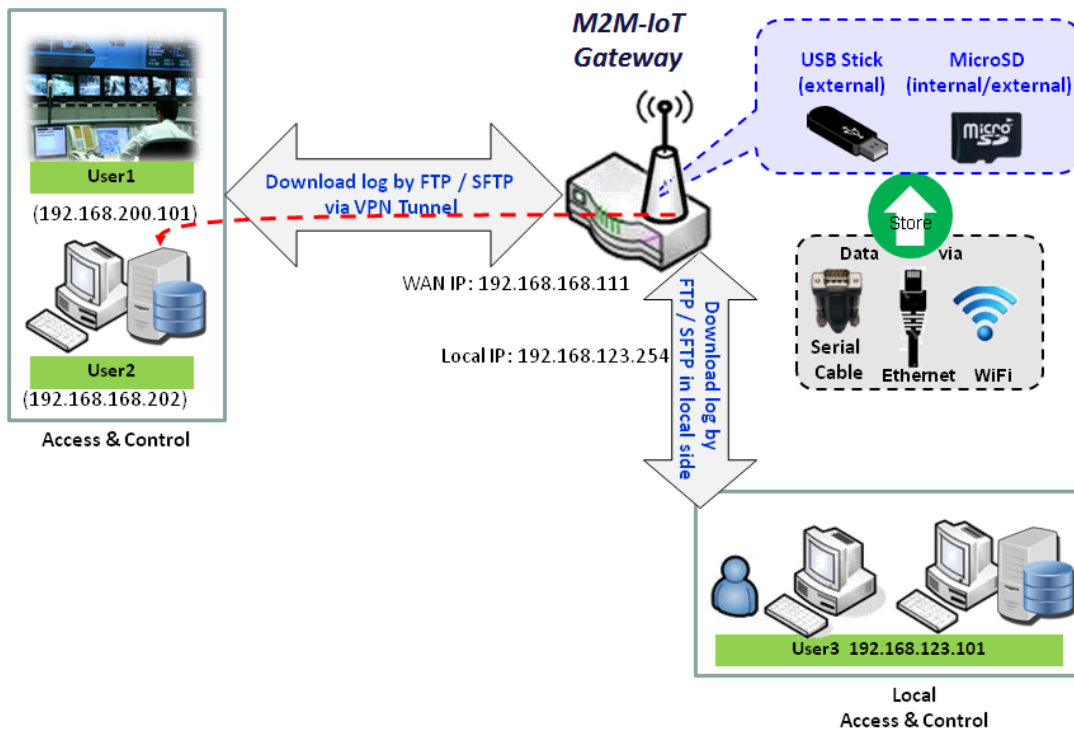

4G IIoT LoRa Gateway

6.3.1 Server Configuration

This section allows user to setup the embedded FTP and SFTP server for retrieving the interested fog files.

Go to **Administration > FTP > Server Configuration** tab.

Enable FTP Server

Item	Setting
▶ FTP	<input checked="" type="checkbox"/> Enable
▶ FTP Port	<input type="text" value="21"/>
▶ Timeout	<input type="text" value="300"/> second(s)(60-7200)
▶ Max. Connections per IP	<input type="text" value="2"/> ▼
▶ Max. FTP Clients	<input type="text" value="5"/> ▼
▶ PASV Mode	<input type="checkbox"/> Enable
▶ Port Range of PASV Mode	<input type="text" value="50000"/> ~ <input type="text" value="50031"/>
▶ Auto Report External IP in PASV Mode	<input type="checkbox"/> Enable
▶ ASCII Transfer Mode	<input type="checkbox"/> Enable
▶ FTPS(FTP over SSL/TLS)	<input type="checkbox"/> Enable

Configuration Item	Value setting	Description
FTP	The box is unchecked by default.	Check Enable box to activate the embedded FTP Server function. With the FTP Server enabled, you can retrieve or delete the stored log files via FTP connection. Note: The embedded FTP Server is only for log downloading, so no any write permission is implemented for user file upload to the storage.
FTP Port	Port 21 is set by default	Specify a port number for FTP connection. The gateway will listen for incoming FTP connections on the specified port. Value Range: 1 ~ 65535.
Timeout	300 seconds is set by default.	Specify the maximum timeout interval for the FTP connection. Supported range is 60 to 7200 seconds.
Max. Connections per IP	2 Clients are set by default.	Specify the maximum number of clients from the same IP address for the FTP connection. Up to 5 clients from the same IP address is supported.
Max. FTP Clients	5 Clients are set by default.	Specify the maximum number of clients for the FTP connection. Up to 32 clients is supported.
PASV Mode	Optional setting	Check the Enable box to activate the support of PASV mode for a FTP connection from FTP clients.

4G IIoT LoRa Gateway

Port Range of PASV Mode	Port 50000 ~ 50031 is set by default.	Specify the port range to allocate for PASV style data connection. <u>Value Range:</u> 1024 ~ 65535.
Auto Report External IP in PASV Mode	Optional setting	Check the Enable box to activate the support of overriding the IP address advertising in response to the PASV command.
ASCII Transfer Mode	Optional setting	Check the Enable box to activate the support of ASCII mode data transfers. Binary mode is supported by default.
FTPS (FTP over SSL/TLS)	Optional setting	Check the Enable box to activate the support of secure connections via SSL/TLS.

Enable SFTP Server

SFTP Server Configuration
Save
⏪ ⏩

Item	Setting
▶ SFTP	<input type="checkbox"/> Enable via <input checked="" type="checkbox"/> LAN via <input checked="" type="checkbox"/> WAN (WAN-1 <input checked="" type="checkbox"/> WAN-4 <input type="checkbox"/>) <input type="text"/>
▶ SFTP Port	<input type="text" value="22"/>

Configuration Item	Value setting	Description
SFTP	The box is unchecked by default.	Check Enable box to activate the embedded SFTP Server function. Furthermore, you can check the granted interface(s) for the SFTP connection, via LAN , WAN , or both. <ul style="list-style-type: none"> With the SFTP Server enabled, you can retrieve or delete the stored log files via secure SFTP connection.
SFTP Port	Default 22	Specify a port number for SFTP connection. The gateway will listen for incoming SFTP connections on the specified port. <u>Value Range:</u> 1 ~ 65535.

4G IIoT LoRa Gateway

6.3.2 User Account

This section allows user to setup user accounts for logging to the embedded FTP and SFTP server to retrieve the interested fog files.

Go to **Administration > FTP > User Account** tab.

Create/Edit FTP User Accounts



ID	User Name	Password	Directory	Permission	Enable	Actions
----	-----------	----------	-----------	------------	--------	---------

When **Add** button is applied, **User Account Configuration** screen will appear.

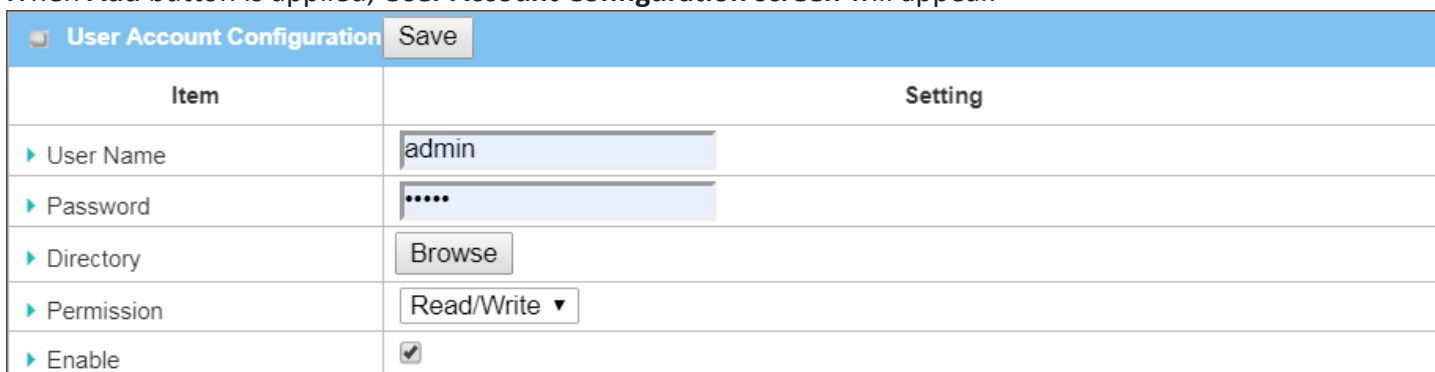

Item	Setting
User Name	admin
Password
Directory	Browse
Permission	Read/Write ▾
Enable	<input checked="" type="checkbox"/>

Configuration		
Item	Value setting	Description
User Name	String : non-blank string	Enter the user account for login to the FTP server. <i>Value Range: 1 ~ 15 characters.</i>
Password	String : no blank	Enter the user password for login to the FTP server.
Directory	N/A	Select a root directory after user login.
Permission	Read/Write is selected by default.	Select the Read/write permission. Note: The embedded FTP Server is only for log downloading, so no any write permission is implemented for user file upload to the storage, even Read/Write option is selected.
Enable	The box is checked by default.	Check the box to activate the FTP user account.

4G IIoT LoRa Gateway

6.4 Diagnostic

This gateway supports simple network diagnosis tools for the administrator to troubleshoot and find the root cause of the abnormal behavior or traffics passing through the gateway. There can be a Packet Analyzer to help record the packets for a designated interface or specific source/destination host, and another Ping and Tracert tools for testing the network connectivity issues.

6.4.1 Diagnostic Tools

The Diagnostic Tools provide some frequently used network connectivity diagnostic tools (approaches) for the network administrator to check the device connectivity.

Go to **Administration > Diagnostic > Diagnostic Tools** tab.

Item	Setting
▶ Ping Test	Host IP: <input type="text"/> Outer Interface: <input type="text" value="Auto"/> LAN Source: <input type="text" value="Default"/> <input type="button" value="Ping"/>
▶ Tracert Test	Host IP: <input type="text"/> Interface: <input type="text" value="Auto"/> <input type="text" value="UDP"/> <input type="button" value="Tracert"/>
▶ Speed Test	Interface: <input type="text" value="Auto"/> mode: <input type="text" value="DL+UL"/> <input type="checkbox"/> SSL <input type="button" value="Test"/>
▶ Wake on LAN	<input type="text"/> <input type="button" value="Wake up"/>

Diagnostic Tools		
Item	Value setting	Description
Ping Test	Optional Setting	This allows you to specify an IP / FQDN, the Outer interface (auto, WAN, LAN, or VLAN), and LAN source (default, LAN, or VLAN) as well, so system will try to ping the specified device to test whether it is alive after clicking on the Ping button. A test result window will appear beneath it.
Tracert Test	Optional setting	Trace route (tracert) command is a network diagnostic tool for displaying the route (path) and measuring transit delays of packets across an IP network. Trace route proceeds until all (three) sent packets are lost for more than twice, then the connection is lost and the route cannot be evaluated. First, you need to specify an IP / FQDN, the test interface (LAN, WAN, or Auto) and the protocol (UDP or ICMP), and by default, it is UDP . Then, system will try to trace the specified host to test whether it is alive after clicking on Tracert button. A test result window will appear beneath it.
Speed Test	Optional setting	This allow you to do q quick speed test for verifying the connectivity on specific interface.
Wake on LAN	Optional setting	Wake on LAN (WOL) is an Ethernet networking standard that allows a computer to be turned on or awakened by a network message. You can specify the MAC address of the computer, in your LAN network, to be remotely turned on by clicking on the Wake up command button.

4G IIoT LoRa Gateway

Save	N/A	Click the Save button to save the configuration.
------	-----	---

4G IIoT LoRa Gateway

6.4.2 Packet Analyzer

The Packet Analyzer can capture packets depend on user settings. User can specify interfaces to capture packets and filter by setting rule. Ensure the log storage is available (either embedded SD-Card or external USB Storage), otherwise **Packet Analyzer** cannot be enabled.

Go to **Administration > Diagnostic > Packet Analyzer** tab.

Item	Setting
▶ Packet Analyzer	<input type="checkbox"/> Enable
▶ File Name	<input type="text"/>
▶ Split Files	<input type="checkbox"/> Enable File Size : <input type="text" value="200"/> <input type="text" value="KB"/> ▾
▶ Packet Interfaces	<input type="checkbox"/> WAN-1 <input type="checkbox"/> WAN-2 <input type="checkbox"/> WAN-3 <input type="checkbox"/> WAN-4 <input type="checkbox"/> ASY <input type="text" value="Binary Mode"/> ▾ 2.4G : <input type="checkbox"/> VAP-1 <input type="checkbox"/> VAP-2 <input type="checkbox"/> VAP-3 <input type="checkbox"/> VAP-4 <input type="checkbox"/> VAP-5 <input type="checkbox"/> VAP-6 <input type="checkbox"/> VAP-7 <input type="checkbox"/> VAP-8 5G : <input type="checkbox"/> VAP-1 <input type="checkbox"/> VAP-2 <input type="checkbox"/> VAP-3 <input type="checkbox"/> VAP-4 <input type="checkbox"/> VAP-5 <input type="checkbox"/> VAP-6 <input type="checkbox"/> VAP-7 <input type="checkbox"/> VAP-8

Configuration		
Item	Value setting	Description
Packet Analyzer	The box is unchecked by default.	Check Enable box to activate the Packet Analyzer function. If you cannot enable the checkbox, please check if the storage is available or not. Plug in the USB storage and then enable the Package Analyzer function.
File Name	1. An optional setting 2. Blank is set by default, and the default file name is <Interface>_<Date>_<index>.	Enter the file name to save the captured packets in log storage. If Split Files option is also enabled, the file name will be appended with an index code “_<index>”. The extension file name is .pcap .
Split Files	1. An optional setting 2. The default value of File Size is 200 KB.	Check enable box to split file whenever log file reaching the specified limit. If the Split Files option is enabled, you can further specify the File Size and Unit for the split files. Value Range: 10 ~ 99999. NOTE: File Size cannot be less than 10 KB
Packet Interfaces	An optional setting	Define the interface(s) that Packet Analyzer should work on. At least, one interface is required, but multiple selections are also accepted. The supported interfaces can be: <ul style="list-style-type: none"> ● WAN: When the WAN is enabled at Physical Interface, it can be selected here. ● ASY: This means the serial communication interface. It is used to capture packets appearing in the Field Communication.

4G IIoT LoRa Gateway

		Therefore, it can only be selected when specific field communication protocol, like Modbus, is enabled. Select Binary mode or String mode for the serial interface.
		<ul style="list-style-type: none"> ● VAP: This means the virtual AP. When WiFi and VAP are enabled, it can be selected here.
Save	N/A	Click the Save button to save the configuration.
Undo	N/A	Click the Undo button to restore what you just configured back to the previous setting.

Once you enabled the Packet Analyzer function on specific Interface(s), you can further specify some filter rules to capture the packets which matched the rules.

☰ Capture Filters
⬆️ ✕

Item	Setting
▶ Filter	<input type="checkbox"/> Enable
▶ Source MACs	<div style="border: 1px solid #ccc; height: 30px; width: 100%;"></div>
▶ Source IPs	<div style="border: 1px solid #ccc; height: 30px; width: 100%;"></div>
▶ Source Ports	<div style="border: 1px solid #ccc; height: 30px; width: 100%;"></div>
▶ Destination MACs	<div style="border: 1px solid #ccc; height: 30px; width: 100%;"></div>
▶ Destination IPs	<div style="border: 1px solid #ccc; height: 30px; width: 100%;"></div>
▶ Destination Ports	<div style="border: 1px solid #ccc; height: 30px; width: 100%;"></div>

Capture Filters		
Item	Value setting	Description
Filter	Optional setting	Check Enable box to activate the Capture Filter function.
Source MACs	Optional setting	Define the filter rule with Source MACs , which means the source MAC address of packets. Packets which match the rule will be captured. Up to 10 MACs are supported, but they must be separated with “;”, e.g. AA:BB:CC:DD:EE:FF; 11:22:33:44:55:66 The packets will be captured when match any one MAC in the rule.
Source IPs	Optional setting	Define the filter rule with Source IPs , which means the source IP address of packets.

4G IIoT LoRa Gateway

		<p>Packets which match the rule will be captured. Up to 10 IPs are supported, but they must be separated with “;”, e.g. 192.168.1.1; 192.168.1.2 The packets will be captured when match any one IP in the rule.</p>
Source Ports	Optional setting	<p>Define the filter rule with Source Ports, which means the source port of packets. The packets will be captured when match any port in the rule. Up to 10 ports are supported, but they must be separated with “;”, e.g. 80; 53 <i>Value Range:</i> 1 ~ 65535.</p>
Destination MACs	Optional setting	<p>Define the filter rule with Destination MACs, which means the destination MAC address of packets. Packets which match the rule will be captured. Up to 10 MACs are supported, but they must be separated with “;”, e.g. AA:BB:CC:DD:EE:FF; 11:22:33:44:55:66 The packets will be captured when match any one MAC in the rule.</p>
Destination IPs	Optional setting	<p>Define the filter rule with Destination IPs, which means the destination IP address of packets. Packets which match the rule will be captured. Up to 10 IPs are supported, but they must be separated with “;”, e.g. 192.168.1.1; 192.168.1.2 The packets will be captured when match any one IP in the rule.</p>
Destination Ports	Optional setting	<p>Define the filter rule with Destination Ports, which means the destination port of packets. The packets will be captured when match any port in the rule. Up to 10 ports are supported, but they must be separated with “;”, e.g. 80; 53 <i>Value Range:</i> 1 ~ 65535.</p>

Chapter 7 Service

7.1 Cellular Toolkit

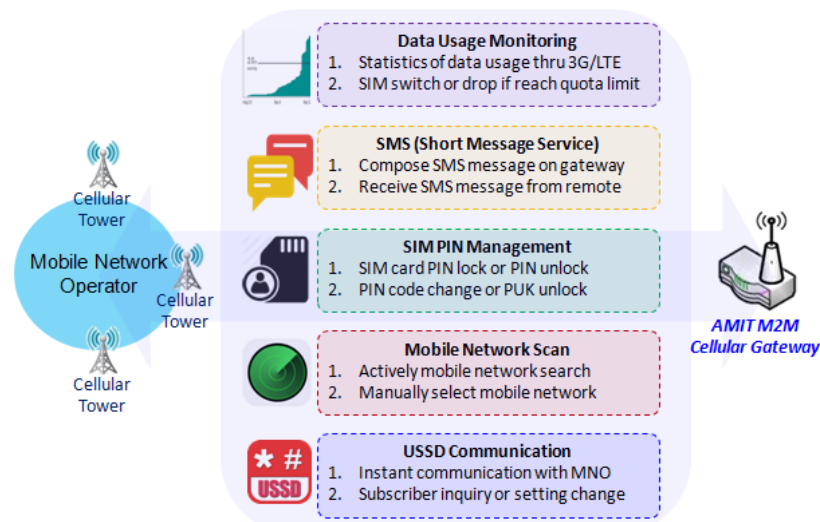

Besides cellular data connection, you may also like to monitor data usage of cellular WAN, sending text message through SMS, changing PIN code of SIM card, communicating with carrier/ISP by USSD command, or doing a cellular network scan for diagnostic purpose.

In Cellular Toolkit section, it includes several useful features that are related to cellular configuration or application. You can configure settings of Data Usage, SMS, SIM PIN, USSD, and Network Scan here. Please note at least a valid SIM card is required to be

inserted to device before you continue settings in this section.

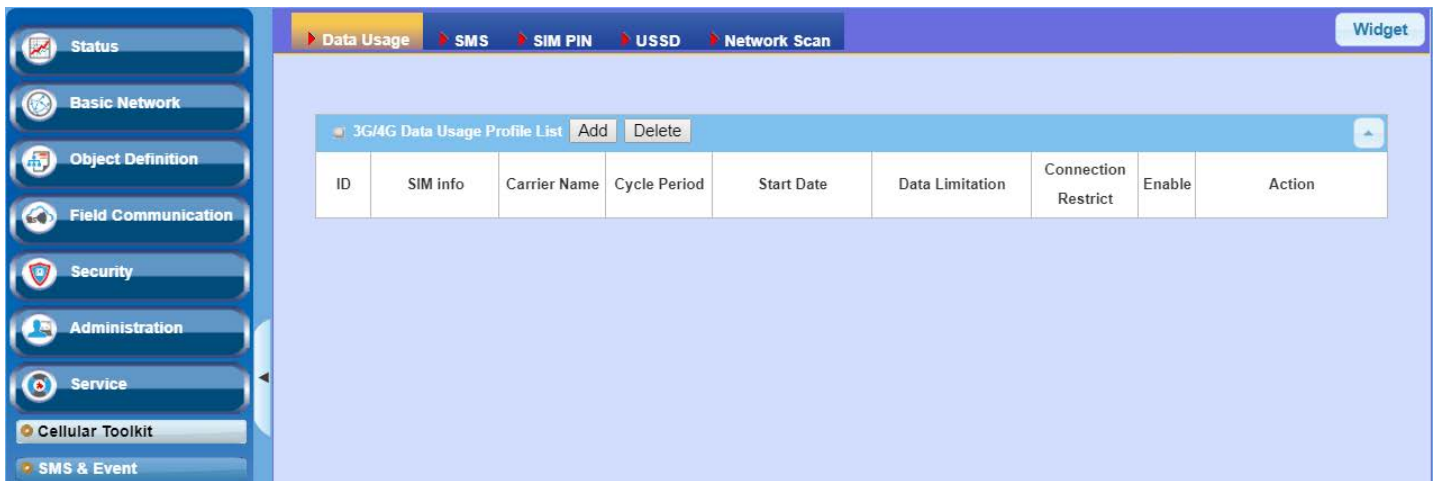

4G IIoT LoRa Gateway

7.1.1 Data Usage

Most of data plan for cellular connection is with a limited amount of data usage. If data usage has been over limited quota, either you will get much lower data throughput that may affect your daily operation, or you will get a 'bill shock' in the next month because carrier/ISP charges a lot for the over-quota data usage.

With help from Data Usage feature, device will monitor cellular data usage continuously and take actions. If data usage reaches limited quota, device can be set to drop the cellular data connection right away. Otherwise, if secondary SIM card is inserted, device will switch to secondary SIM and establish another cellular data connection with secondary SIM automatically.

If Data Usage feature is enabled, all history of cellular data usage can be viewed at **Status > Statistics & Reports > Cellular Usage** tab.

ID	SIM info	Carrier Name	Cycle Period	Start Date	Data Limitation	Connection Restrict	Enable	Action
1	3G/4G SIM A	ISP A	1 Monthly	Mon Apr 01 2019 00:00:00 GMT+0800	1GB	<input checked="" type="checkbox"/>	<input checked="" type="checkbox"/>	<input type="button" value="Edit"/> <input type="checkbox"/> Select

3G/4G Data Usage

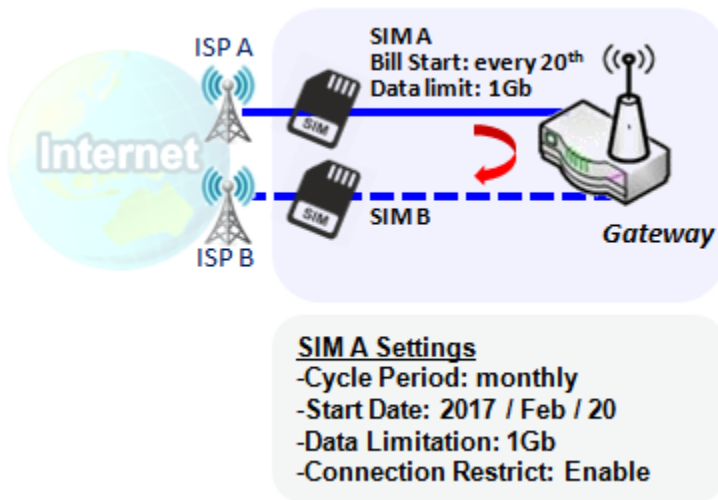

Data Usage feature enabling gateway device to continuously monitor cellular data usage and take actions. In the diagram, quota limit of SIM A is **1Gb** per month and bill start date is **20th** of every month. The device is smart to start a new calculation of data usage on every **20th** of month. Enable Connection Restrict will force gateway device to drop cellular connection of SIM A when data usage reaches quota limit (1Gb in this case). If SIM failover feature is configured in **Internet Setup**, then gateway will switch to SIM B and establish a new cellular data connection automatically.

4G IIoT LoRa Gateway

Data Usage Setting

Go to **Service > Cellular Toolkit > Data Usage** tab.

Before finished settings for Data Usage, you need to know bill start date, bill period, and quota limit of data usage according to your data plan. You can ask this information from your carrier or ISP.

Create / Edit 3G/4G Data Usage Profile

3G/4G Data Usage Profile List Add Delete								
ID	SIM info	Carrier Name	Cycle Period	Start Date	Data Limitation	Connection Restrict	Enable	Action

When **Add** button is applied, 3G/4G Data Usage Profile Configuration screen will appear. You can create up to four data usage profiles, one profile for each SIM card used in the Gateway.

3G/4G Data Usage Profile Configuration	
Item	Setting
▶ SIM Select	3G/4G ▼ SIM A ▼
▶ Carrier Name	<input type="text"/>
▶ Cycle Period	Days ▼ <input type="text"/>
▶ Start Date	2019 ▼ / April ▼ / 1 ▼
▶ Data Limitation	<input type="text"/> KB ▼
▶ Connection Restrict	<input type="checkbox"/> Enable
▶ Enable	<input checked="" type="checkbox"/> Enable

3G/4G Data Usage Profile Configuration		
Item	Setting	Description
SIM Select	3G/4G-1 and SIM A by default.	Choose a cellular interface (3G/4G-1 or 3G/4G-2), and a SIM card bound to the selected cellular interface to configure its data usage profile. Note: 3G/4G-2 is only available for for the product with dual cellular module.
Carrier Name	It is an optional item.	Fill in the Carrier Name for the selected SIM card for identification.
Cycle Period	Days by default	The first box has three types for cycle period. They are Days , Weekly and Monthly . Days: For per Days cycle periods, you have to further specify the number of days in the second box. Value Range: 1 ~ 90 days. Weekly, Monthly: The cycle period is one week or one month.
Start Date	N/A	Specify the date to start measure network traffic. Please don't select the day before now, otherwise, the traffic statistics will be incorrect.
Data Limitation	N/A	Specify the allowable data limitation for the defined cycle period.

4G IIoT LoRa Gateway

Connection Restrict	Un-Checked by default.	Check the Enable box to activate the connection restriction function. During the specified cycle period, if the actual data usage exceeds the allowable data limitation, the cellular connection will be forced to disconnect.
Enable	Un-Checked by default.	Check the Enable box to activate the data usage profile.

4G IIoT LoRa Gateway

7.1.2 SMS

Short Message Service (SMS) is a text messaging service, which is used to be widely-used on mobile phones. It uses standardized communications protocols to allow mobile phones or cellular devices to exchange short text messages in an instant and convenient way.

SMS Setting

Go to **Service > Cellular Toolkit > SMS** tab

With this gateway device, you can send SMS text messages or browse received SMS messages as you usually do on a cellular phone.

Setup SMS Configuration

Item	Setting
▶ Physical Interface	3G/4G-1 ▾
▶ SMS	<input checked="" type="checkbox"/> Enable SIM Status: SIM_A
▶ SMS Storage	SIM Card Only ▾
▶ SMS Space	<input type="checkbox"/> Enable & Keep Available Space <input type="text" value="1-10"/> (1-10)

Configuration Item	Value setting	Description
Physical Interface	The box is 3G/4G-1 by default	Choose a cellular interface (3G/4G-1 or 3G/4G-2) for the following SMS function configuration. Note: 3G/4G-2 is only available for for the product with dual cellular module.
SMS	The box is checked by default	This is the SMS switch. If the box checked that the SMS function enable, if the box unchecked that the SMS function disable.
SIM Status	N/A	Depend on currently SIM status. The possible value will be SIM_A or SIM_B .
SMS Storage	The box is SIM Card Only by default	This is the SMS storage location. Currently the option only SIM Card Only .
SMS Space	The box is unchecked by default	Check the Enable box and specify a number (1-10) for message count to reserve some available storage space and prevent it from run out of storage. The oldest message(s) will be deleted when the SMS storage is going to full.
Save	N/A	Click the Save button to save the settings

4G IIoT LoRa Gateway

SMS Summary

Show **Unread SMS**, **Received SMS**, **Sent SMS**, **Remaining SMS**, and edit SMS context to send, read SMS from SIM card.

Item	Setting
▶ Unread SMS	0
▶ Received SMS	10
▶ Sent SMS	0
▶ Remaining SMS	0

SMS Summary		
Item	Value setting	Description
Unread SMS	N/A	If SIM card insert to router first time, unread SMS value is zero. When received the new SMS but didn't read, this value plus one.
Received SMS	N/A	This value record the existing SMS numbers from SIM card, When received the new SMS, this value plus one.
Sent SMS	N/A	This value record the number of out going SMS, When sent one SMS, this value plus one.
Remaining SMS	N/A	This value is SMS capacity minus received SMS, When received the new SMS, this value minus one.
New SMS	N/A	Click New SMS button, a New SMS screen appears. User can set the SMS setting from this screen. Refer to New SMS in the next page.
SMS Inbox	N/A	Click SMS Inbox button, a SMS Inbox List screen appears. User can read or delete SMS, reply SMS or forward SMS from this screen. Refer to SMS Inbox List in the next page.
Refresh	N/A	Click the Refresh button to update the SMS summary immediately.

4G IIoT LoRa Gateway

New SMS

You can set the SMS setting from this screen.

Item	Setting
Receivers	<input type="text"/> (Use '+' for International Format and ';' to Compose Multiple Receivers)
Text Message	<div style="border: 1px solid #ccc; height: 100px;"></div> Length of Current Input : 0
Result	

New SMS		
Item	Value setting	Description
Receivers	N/A	Write the receivers to send SMS. User need to add the semicolon and compose multiple receivers that can group send SMS.
Text Message	N/A	Write the SMS context to send SMS. The router supports up to a maximum of 1023 character for SMS context length.
Send	N/A	Click the Send button, above text message will be sent as a SMS.
Result	N/A	If SMS has been sent successfully, it will show Send OK , otherwise Send Failed will be displayed.

SMS Inbox List

You can read or delete SMS, reply SMS or forward SMS from this screen.

ID	From Phone Number	Timestamp	SMS Text Preview	Actions
----	-------------------	-----------	------------------	---------

SMS Inbox List		
Item	Value setting	Description
ID	N/A	The number of SMS.
From Phone Number	N/A	Sender List (Phone Number) for the received SMS
Timestamp	N/A	What time the SMS is received
SMS Text Preview	N/A	Preview the SMS text. Click the Detail button to read a certain message.

4G IIoT LoRa Gateway

Action	The box is unchecked by default	Click the Detail button to read the SMS detail; Click the Reply / Forward button to reply/forward SMS. Besides, you can check the box(es), and then click the Delete button to delete the checked SMS(s).
Refresh	N/A	Refresh the SMS Inbox List.
Delete	N/A	Delete the SMS for all checked box from Action.
Close	N/A	Close the Detail SMS Message screen.

SMS Sent Folder

You can read or delete SMS from this screen.

ID	Receivers	Timestamp	SMS Text Preview	Actions

SMS Sent Folder		
Item	Value setting	Description
ID	N/A	The number of SMS.
Receivers	N/A	Receiver list for the sent SMS.
Timestamp	N/A	What time the SMS is sent
SMS Text Preview	N/A	Preview the SMS text. Click the Detail button to read a certain message.
Action	The box is unchecked by default	Click the Detail button to read the SMS detail Besides, you can check the box(es), and then click the Delete button to delete the checked record(s).
Refresh	N/A	Refresh the SMS Sent Folder.
Delete	N/A	Delete the SMS for all checked box from Action.
Close	N/A	Close the Detail SMS Message screen.

4G IIoT LoRa Gateway

7.1.3 SIM PIN

With most cases in the world, users need to insert a SIM card (a.k.a. UICC) into end devices to get on cellular network for voice service or data surfing. The SIM card is usually released by mobile operators or service providers. Each SIM card has a unique number (so-called ICCID) for network owners or service providers to identify each subscriber. As SIM card plays an important role between service providers and subscribers, some security mechanisms are required on SIM card to prevent any unauthorized access.

Enabling a PIN code in SIM card is an easy and effective way of protecting cellular devices from unauthorized access. This gateway device allows you to activate and manage PIN code on a SIM card through its web GUI.

Activate PIN code on SIM Card

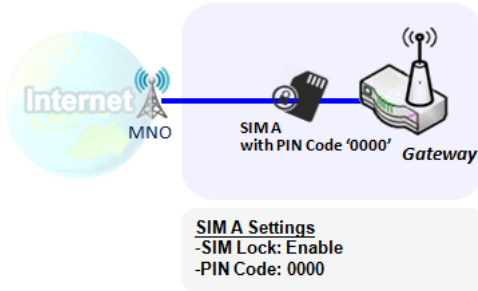

This gateway device allows you to activate PIN code on SIM card. This example shows how to activate PIN code on SIM-A for 3G/4G-1 with default PIN code “0000”.

Change PIN code on SIM Card

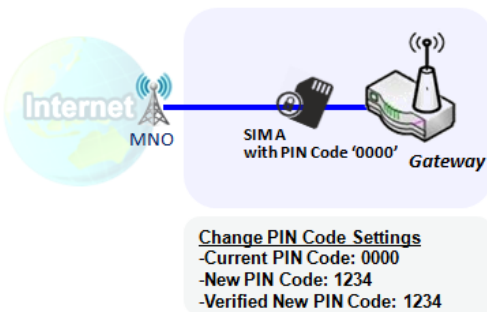

This gateway device allows you to change PIN code on SIM card. Following the example above, you need to type original PIN code “0000”, and then type new PIN code with ‘1234’ if you like to set new PIN code as ‘1234’. To confirm the new PIN code you type is what you want, you need to type new PIN code ‘1234’ in Verified New PIN Code again.

Unlock SIM card by PUK Code

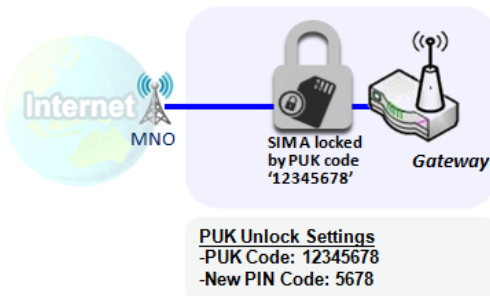

If you entered incorrect PIN code at configuration page for 3G/4G-1 WAN over three times, and then it will cause SIM card to be locked by PUK code. Then you have to call service number to get a PUK code to unlock SIM card. In the diagram, the PUK code is “12345678” and new PIN code is “5678”.

4G IIoT LoRa Gateway

SIM PIN Setting

Go to **Service** > **Cellular Toolkit** > **SIM PIN** Tab

With the SIM PIN Function window, it allows you to enable or disable SIM lock (which means protected by PIN code), or change PIN code. You can also see the information of remaining times of failure trials as we mentioned earlier. If you run out of these failure trials, you need to get a PUK code to unlock SIM card.

Select a SIM Card

Configuration	
Item	Setting
▶ Physical Interface	3G/4G-1 ▼
▶ SIM Status	SIM-A Ready
▶ SIM Selection	SIM-A ▼ <input type="button" value="Switch"/>

Configuration Window		
Item	Value setting	Description
Physical Interface	The box is 3G/4G-1 by default	Choose a cellular interface (3G/4G-1 or 3G/4G-2) to change the SIM PIN setting for the selected SIM Card. Note: 3G/4G-2 is only available for for the product with dual cellular module.
SIM Status	N/A	Indication for the selected SIM card and the SIM card status. The status could be Ready , Not Insert , or SIM PIN . Ready -- SIM card is inserted and ready to use. It can be a SIM card without PIN protection or that SIM card is already unlocked by correct PIN code. Not Insert -- No SIM card is inserted in that SIM slot. SIM PIN -- SIM card is protected by PIN code, and it's not unlocked by a correct PIN code yet. That SIM card is still at locked status.
SIM Selection	N/A	Select the SIM card for further SIM PIN configuration. Press the Switch button, then the Gateway will switch SIM card to another one. After that, you can configure the SIM card.

4G IIoT LoRa Gateway

Enable / Change PIN Code

Enable or Disable PIN code (password) function, and even change PIN code function.

SIM function	
<input type="button" value="Save"/> <input type="button" value="Change PIN Code"/>	
Item	Setting
▶ PIN Lock	<input checked="" type="checkbox"/> Enable PIN Code: <input type="text"/> (4~8 digits)
▶ Remaining times	N/A

SIM function Window		
Item Setting	Value setting	Description
SIM lock	Depend on SIM card	Click the Enable button to activate the SIM lock function. For the first time you want to enable the SIM lock function, you have to fill in the PIN code as well, and then click Save button to apply the setting.
Remaining times	Depend on SIM card	Represent the remaining trial times for the SIM PIN unlocking.
Save	N/A	Click the Save button to apply the setting.
Change PIN Code	N/A	Click the Change PIN code button to change the PIN code (password). If the SIM Lock function is not enabled, the Change PIN code button is disabled. In the case, if you still want to change the PIN code, you have to enable the SIM Lock function first, fill in the PIN code, and then click the Save button to enable. After that, You can click the Change PIN code button to change the PIN code.

When **Change PIN Code** button is clicked, the following screen will appear.

Item	Setting
▶ Current PIN Code	<input type="text"/> (4~8 digits)
▶ New PIN Code	<input type="text"/> (4~8 digits)
▶ Verified New PIN Code	<input type="text"/> (4~8 digits)

Item	Value Setting	Description
Current PIN Code	A Must filled setting	Fill in the current (old) PIN code of the SIM card.
New PIN Code	A Must filled setting	Fill in the new PIN Code you want to change.
Verified New PIN Code	A Must filled setting	Confirm the new PIN Code again.
Apply	N/A	Click the Apply button to change the PIN code with specified new PIN code.
Cancel	N/A	Click the Cancel button to cancel the changes and keep current PIN code.

Note: If you changed the PIN code for a certain SIM card, you must also change the corresponding PIN code specified in the **Basic Network > WAN & Uplink > Internet Setup > Connection with SIM Card** page.

4G IIoT LoRa Gateway

Otherwise, it may result in wrong SIM PIN trials with invalid (old) PIN code.

Unlock with a PUK Code

The PUK Function window is only available for configuration if that SIM card is locked by PUK code. It means that SIM card is locked and needs additional PUK code to unlock. Usually it happens after too many trials of incorrect PIN code, and the remaining times in SIM Function table turns to 0. In this situation, you need to contact your service provider and request a PUK code for your SIM card, and try to unlock the locked SIM card with the provided PUK code. After unlocking a SIM card by PUK code successfully, the SIM lock function will be activated automatically.

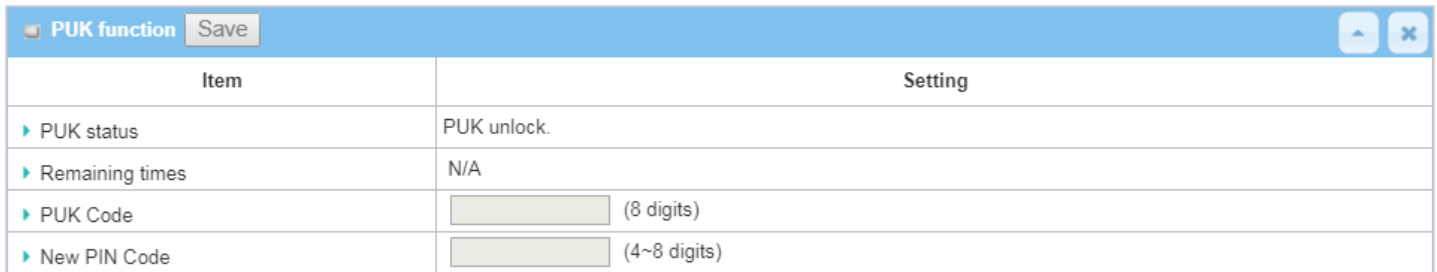

Item	Setting
▶ PUK status	PUK unlock.
▶ Remaining times	N/A
▶ PUK Code	<input type="text"/> (8 digits)
▶ New PIN Code	<input type="text"/> (4~8 digits)

PUK Function Window		
Item	Value setting	Description
PUK status	PUK Unlock / PUK Lock	Indication for the PUK status. The status could be PUK Lock or PUK Unlock . As mentioned earlier, the SIM card will be locked by PUK code after too many trials of failure PIN code. In this case, the PUK Status will turn to PUK Lock . In a normal situation, it will display PUK Unlock .
Remaining times	Depend on SIM card	Represent the remaining trial times for the PUK unlocking. Note : DO NOT make the remaining times down to zero, it will damage the SIM card FOREVER ! Call for your ISP's help to get a correct PUK and unlock the SIM if you don't have the PUK code.
PUK Code	A Must filled setting	Fill in the PUK code (8 digits) that can unlock the SIM card in PUK unlock status.
New PIN Code	A Must filled setting	Fill in the New PIN Code (4~8 digits) for the SIM card. You have to determine your new PIN code to replace the old, forgotten one. Keep the PIN code (password) in mind with care.
Save	N/A	Click the Save button to apply the setting.

Note: If you changed the PUK code and PIN code for a certain SIM card, you must also change the corresponding PIN code specified in the **Basic Network > WAN & Uplink > Internet Setup > Connection with SIM Card** page. Otherwise, it may result in wrong SIM PIN trials with invalid (old) PIN code.

4G IIoT LoRa Gateway

7.1.4 USSD

Unstructured Supplementary Service Data (USSD) is a protocol used by GSM cellular telephones to communicate with the service provider's computers. USSD can be used for WAP browsing, prepaid callback service, mobile-money services, location-based content services, menu-based information services, and as part of configuring the phone on the network.

An USSD message is up to 182 alphanumeric characters in length. Unlike Short Message Service (SMS) messages, USSD messages create a real-time connection during an USSD session. The connection remains open, allowing a two-way exchange of a sequence of data. This makes USSD more responsive than services that use SMS.

Configuration [↑] [×]

Item	Setting
Physical Interface	3G/4G-1 ▼ SIM Status: SIM_A

USSD Profile List [Add] [Delete] [↑] [×]

ID	Profile Name	USSD Command	Comments	Actions
----	--------------	--------------	----------	---------

USSD Request [Send] [Clear] [Cancel] [↑] [×]

Item	Setting
USSD Profile	--- Option --- ▼
USSD Command	<input type="text"/>

USSD Scenario

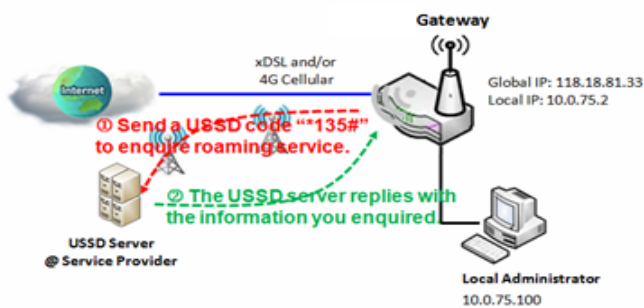

USSD allows you to have an instant bi-directional communication with carrier/ISP. In the diagram, the USSD command **'*135#'** is referred to data roaming services. After sending that USSD command to carrier, you can get a response at window USSD Response. Please note the USSD command varies for different carriers/ISP.

4G IIoT LoRa Gateway

USSD Setting

Go to **Service > Cellular Toolkit > USSD** tab.

In "USSD" page, there are four windows for the USSD function. The "Configuration" window can let you specify which 3G/4G module (physical interface) is used for the USSD function, and system will show which SIM card in the module is the current used one. The second window is the "USSD Profile List" and it shows all your defined USSD profiles that store pre-commands for activating an USSD session. An "Add" button in the window can let you add one new USSD profile and define the command for the profile in the third window, the "USSD Profile Configuration". When you want to start the activation of an USSD connection session to the USSD server, select the USSD profile or type in the correct pre-command, and then click on the "Send" button for the session. The responses from the USSD server will be displayed beneath the "USSD Command" line. When commands typed in the "USSD Command" field are sent, received responses will be displayed in the "USSD Response" blank space. User can communicate with the USSD server by sending USSD commands and getting USSD responses via the gateway.

USSD Configuration

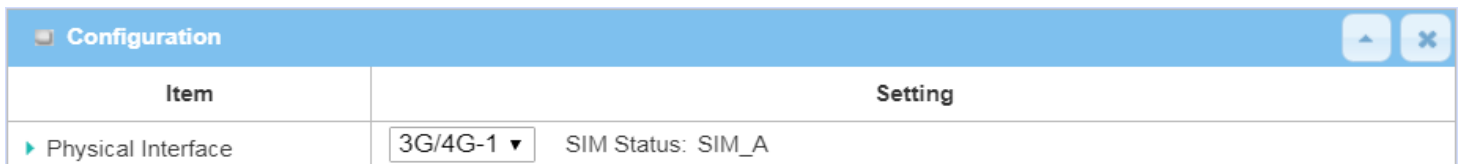

Item	Setting
Physical Interface	3G/4G-1 SIM Status: SIM_A

Configuration Item	Value setting	Description
Physical Interface	The box is 3G/4G-1 by default.	Choose a cellular interface (3G/4G-1 or 3G/4G-2) to configure the USSD setting for the connected cellular service (identified with SIM_A or SIM_B). Note: 3G/4G-2 is only available for for the product with dual cellular module.
SIM Status	N/A	Show the connected cellular service (identified with SIM_A or SIM_B).

Create / Edit USSD Profile

The cellular gateway allows you to custom your USSD profile. It supports up to a maximum of 35 USSD profiles.

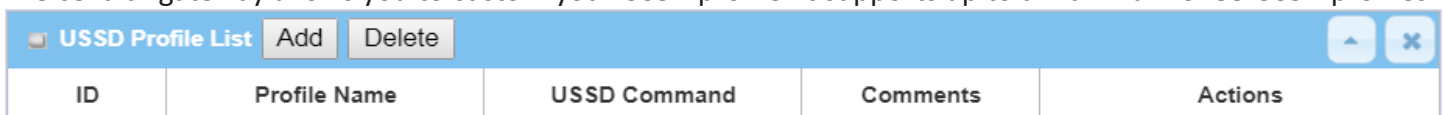

ID	Profile Name	USSD Command	Comments	Actions
----	--------------	--------------	----------	---------

When **Add** button is applied, **USSD Profile Configuration** screen will appear.

4G IIoT LoRa Gateway

USSD Request Send Clear Cancel

Item	Setting
▶ USSD Profile	--- Option --- ▼
▶ USSD Command	<input type="text"/>

USSD Profile Configuration		
Item	Value setting	Description
Profile Name	N/A	Enter a name for the USSD profile.
USSD Command	N/A	Enter the USSD command defined for the profile. Normally, it is a command string composed with numeric keypad "0~9", "*", and "#". The USSD commands are highly related to the cellular service, please check with your service provider for the details.
Comments	N/A	Enter a brief comment for the profile.

Send USSD Request

When **send** the USSD command, the USSD Response screen will appear.

When click the **Clear** button, the USSD Response will disappear.

USSD Request Send Clear Cancel

Item	Setting
▶ USSD Profile	--- Option --- ▼
▶ USSD Command	<input type="text"/>

USSD Request		
Item	Value setting	Description
USSD Profile	N/A	Select a USSD profile name from the dropdown list.
USSD Command	N/A	The USSD Command string of the selected profile will be shown here.
USSD Response	N/A	Click the Send button to send the USSD command, and the USSD Response screen will appear. You will see the response message of the corresponding service, receive the service SMS.

4G IIoT LoRa Gateway

7.1.5 Network Scan

"Network Scan" function can let administrator specify the device how to connect to the mobile system for data communication in each 3G/4G interface. For example, administrator can specify which generation of mobile system is used for connection, 2G, 3G or LTE. Moreover, he can define their connection sequence for the gateway device to connect to the mobile system automatically. Administrator also can scan the mobile systems in the air manually, select the target operator system and apply it. The manual scanning approach is used for problem diagnosis.

Network Scan Setting

Go to **Service > Cellular Toolkit > Network Scan** tab.

In "Network Scan" page, there are two windows for the Network Scan function. The "Configuration" window can let you select which 3G/4G module (physical interface) is used to perform Network Scan, and system will show the current used SIM card in the module. You can configure each 3G/4G WAN interface by executing the network scanning one after another. You can also specify the connection sequence of the targeted generation of mobile system, 2G/3G/LTE.

Network Scan Configuration

Configuration	
Item	Setting
▶ Physical Interface	3G/4G-1 ▼ SIM Status: SIM_A
▶ Network Type	LTE Only ▼
▶ Scan Approach	Auto ▼

Configuration		
Item	Value setting	Description
Physical Interface	The box is 3G/4G-1 by default	Choose a cellular interface (3G/4G-1 or 3G/4G-2) for the network scan function. Note: 3G/4G-2 is only available for for the product with dual cellular module.
SIM Status	N/A	Show the connected cellular service (identified with SIM_A or SIM_B).
Network Type	Auto is selected by default.	Specify the network type for the network scan function. It can be Auto, 2G Only, 2G prefer, 3G Only, 3G prefer, or LTE Only. When Auto is selected, the network will be register automatically; If the prefer option is selected, network will be register for your option first; If the only option is selected, network will be register for your option only.
Scan Approach	Auto is selected by default.	When Auto selected, cellular module register automatically. If the Manually option is selected, a Network Provider List screen appears. Press Scan button to scan for the nearest base stations. Select (check the box) the preferred base stations then click Apply button to apply settings.

4G IIoT LoRa Gateway

Save N/A Click **Save** to save the settings

The second window is the "Network Provider List" window and it appears when the **Manually** Scan Approach is selected in the Configuration window. By clicking on the "Scan" button and wait for 1 to 3 minutes, the found mobile operator system will be displayed for you to choose. Click again on the "Apply" button to drive system to connect to that mobile operator system for the dedicated 3G/4G interface.

Network Provider List <input type="button" value="Scan"/> <input type="button" value="Apply"/>			
Provider Name	Mobile System	Network Status	Action

4G IIoT LoRa Gateway

7.2 SMS & Event

SMS & Event handling is the application that allows administrator to setup the pre-defined events, handlers, or response behavior with individual profiles. With properly configuring the event handling function, administrator can easily and remotely obtain the status and information via the purchased gateway. Moreover, he can also handle and manage some important system related functions, even the field bus devices and D/O devices which are already well connected to.

The supported events are categorized into two groups: the **managing events** and **notifying events**.

The **managing events** are the events that are used to manage the gateway or change the setting / status of the specific functionality of the gateway. On receiving the managing event, the gateway will take action to change the functionality, collect the required status for administration, and also change the status of a certain connected field bus device simultaneously.

The **notifying events** are the events that some related objects have been triggered and take corresponding actions on the occurrence of the events. It could be an event generated from the connected sensor, or a certain connected field bus device for alerting the administrator something happened with SMS message, Email, and SNMP Trap, etc...

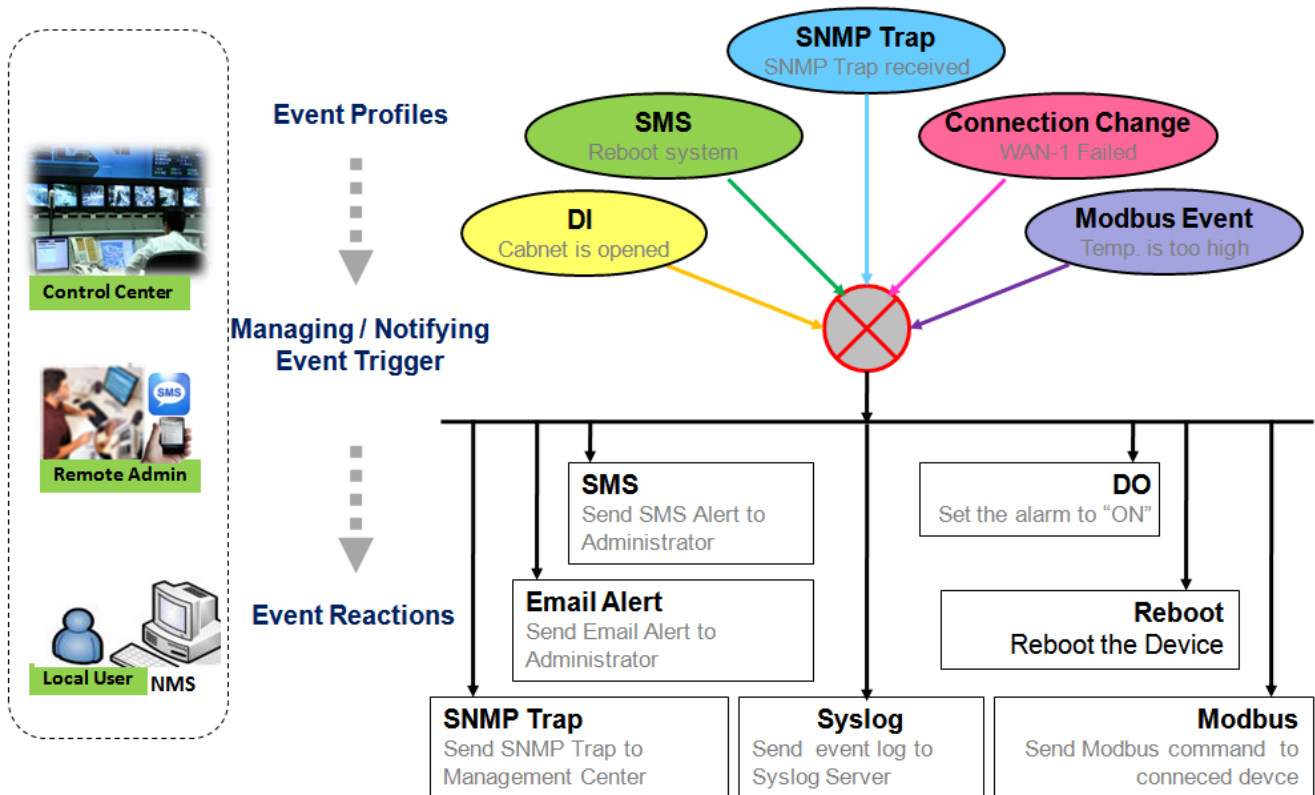

For ease of configuration, administrator can create and edit the common pre-defined managing / notifying event profiles for taking instant reaction on a certain event or managing the devices for some advanced useful purposes. For example, sending/receiving remote managing SMS for the gateway's routine maintaining, the

4G IIoT LoRa Gateway

field bus device status monitoring, digital sensors detection controlling, and so on. All of such management and notification function can be realized effectively via the Event Handling feature.

The following is the summary lists for the provided profiles, and events:

(**Note:** The available profiles and events could be different for the purchased product.)

- Profiles (Rules):
 - SMS Configuration and Accounts
 - Email Accounts
 - Digital Input (DI) profiles
 - Digital Output (DO) profiles
 - Modbus Managing Event profiles
 - Modbus Notifying Event profiles
 - Remote Host profiles
 - MQTT Publish Message profiles

- Managing Events:
 - Trigger Type: SMS, SNMP Trap, and Digital Input (DI).
 - Actions: Get the Network Status; or Configure the LAN/VLAN behavior, WIFI behavior, NAT behavior, Firewall behavior, VPN behavior, System Management, Administration, Digital Output behavior, connected Modbus devices, Remote Host, and MQTT Publish Message.

- Notifying Events:
 - Trigger Type: Digital Input, Power Change, Connection Change (WAN, LAN & VLAN, WiFi, DDNS), Administration, Modbus, and Data Usage.
 - Actions: Notify the administrator with SMS, Syslog, SNMP Trap or Email Alert; Change the status of connected Digital Output or Modbus devices; Sending collected information to Remote Host; and Publishing MQTT Message to a designaged MQTT Broker.

To use the event handling function, First of all, you have to enable the event management setting and configure the event details with the provided profile settings. You can create or edit pre-defined profiles for individual managing / notifying events. The profile settings are separated into several items; they are the SMS Account Definition, Email Service Definition, Digital Input (DI) Profile Configuration, Digital Output (DO) Profile Configuration, Modbus Definition, Remote Host Configuration, and MQTT Publish Message.

Then, you have to configure each managing / notifying event with identifying the event's trigger condition, and the corresponding actions (reaction for the event) for the event. For each event, more than one action can be activated simultaneously.

4G IIoT LoRa Gateway

7.2.1 Configuration

Go to **Service > SMS & Event > Configuration** Tab.

Event handling is the service that allows administrator to setup the pre-defined events, handlers, or response behavior with individual profiles.

Enable Event Management

Configuration	
Item	Setting
▶ Event Management	<input type="checkbox"/> Enable

Item	Value setting	Description
Event Management	The box is unchecked by default	Check the Enable box to activate the Event Management function.

Enable SMS Management

To use the SMS management function, you have to configure some important settings first.

SMS Configuration	
Item	Setting
▶ Message Prefix	<input type="checkbox"/> Enable <input type="text"/>
▶ Physical Interface	<input type="text" value="3G/4G-1"/> SIM Status: SIM_A
▶ Delete Managed SMS after Processing	<input type="checkbox"/> Enable

Item	Value setting	Description
Message Prefix	The box is unchecked by default	Click the Enable box to enable the SMS prefix for validating the received SMS. Once the function is enabled, you have to enter the prefix behind the checkbox. The received managing events SMS must have the designated prefix as an initial identifier, then corresponding handlers will become effective for further processing.
Physical Interface	The box is 3G/4G-1 by default.	Choose a cellular interface (3G/4G-1 or 3G/4G-2) to configure the SMS management setting.

4G IIoT LoRa Gateway

Note: 3G/4G-2 is only available for for the product with dual cellular module.

SIM Status	N/A	Show the connected cellular service (identified with SIM_A or SIM_B).
Delete Managed SMS after Processing	The box is unchecked by default	Check the Enable box to delete the received managing event SMS after it has been processed.

Create / Edit SMS Account

Setup the SMS Account for managing the gateway through the SMS. It supports up to a maximum of 5 accounts.

SMS Account List Add Delete ↑ ×						
ID	Phone Number	Phone Description	Application	Send confirmed SMS	Enable	Actions

You can click the **Add / Edit** button to configure the SMS account.

SMS Account Configuration ×	
Item	Setting
▶ Phone Number	Specific Number ▼ <input type="text"/>
▶ Phone Description	<input type="text"/>
▶ Application	<input type="checkbox"/> Event Trigger <input type="checkbox"/> Notify Handle
▶ Send confirmed SMS	<input type="checkbox"/> Enable
▶ Enable	<input checked="" type="checkbox"/> Enable
Save	

SMS Account Configuration		
Item	Value setting	Description
Phone Number	<ol style="list-style-type: none"> Mobile phone number format A Must filled setting 	Select the Phone number policy from the drop list, and specify a mobile phone number as the SMS account identifier if required. It can be Specific Number , or Allow Any . If Specific Number is selected, you have to specify the phone number as the SMS account identifier. Value Range: -1 ~ 32 digits.
Phone Description	<ol style="list-style-type: none"> Any text An Optional setting 	Specify a brief description for the SMS account.
Application	A Must filled setting	Specify the application type. It could be Event Trigger , Notify Handle , or both . If the Phone Number policy is Allow Any , the Notify Handle will be unavailable.
Send confirmed SMS	<ol style="list-style-type: none"> An Optional setting The box is unchecked by default. 	Click Enable box to active the SMS response function. The gateway will send a confirmed message back to the sender whenever it received a SMS managing event. The confirmed message is similar to following format: <i>"Device received a SMS with command xxxxx."</i>
Enable	The box is unchecked by	Click Enable box to activate this account.

4G IIoT LoRa Gateway

	default.	
Save	NA	Click the Save button to save the configuration.

Create / Edit Email Service Account

Setup the Email Service Account for event notification. It supports up to a maximum of 5 accounts.

Email Service List Add Delete ▲ ✕				
ID	Email Server	Email Addresses	Enable	Actions

You can click the **Add / Edit** button to configure the Email account.

Email Service Configuration ✕	
Item	Setting
▶ Email Server	--- Option --- ▼
▶ Email Addresses	<input type="text"/>
▶ Enable	<input checked="" type="checkbox"/> Enable
Save	

Email Service Configuration		
Item	Value setting	Description
Email Server	--- Option ---	Select an Email Server profile from External Server setting for the email account setting.
Email Addresses	1. Internet E-mail address format 2. A Must filled setting	Specify the Destination Email Addresses.
Enable	The box is unchecked by default.	Click Enable box to activate this account.
Save	NA	Click the Save button to save the configuration

4G IIoT LoRa Gateway

Create / Edit Digital Input (DI) Profile Rule (DI/DO support required)

Setup the Digital Input (DI) Profile rules. It supports up to a maximum of 10 profiles.

Digital Input (DI) Profile List Add Delete								
ID	DI Profile Name	Description	DI Source	Continues Update Status	Normal Level	Signal Active Time (s)	Enable	Actions

When **Add** button is applied, the **Digital Input (DI) Profile Configuration** screen will appear.

Digital Input (DI) Profile Configuration	
Item	Setting
▶ DI Profile Name	<input type="text"/>
▶ Description	<input type="text"/>
▶ DI Source	ID1 ▼
▶ Continues Update Status	<input type="checkbox"/> Enable & Update Interval <input type="text" value="2"/> (2~86400 seconds)
▶ Normal Level	Low ▼
▶ Signal Active Time	<input type="text" value="1"/> (seconds)
▶ Profile	<input checked="" type="checkbox"/> Enable
Save	

Digital Input (DI) Profile Configuration		
Item	Value setting	Description
DI Profile Name	1. String format 2. A Must filled setting	Specify the DI Profile Name. Value Range: -1 ~ 32 characters.
Description	1. Any text 2. An Optional setting	Specify a brief description for the profile.
DI Source	ID1 by default	Specify the DI Source. It could be ID1 or ID2 . The number of available DI source could be different for the purchased product.
Continue Update Status	The box is unchecked by default.	Click Enable box to activate this function for the DI event with designated update interval setting. If the event condition keeps active for a long time interval, the gateway will send repeated notify events for each check interval. Value Range: 2 ~ 86400 seconds. Note : To prevent receiving too much notify event for the same situation, you can adjust the check interval to a proper one for your application.
Normal Level	Low by default	Specify the Normal Level. It could be Low or High .
Signal Active Time	1. Numeric String format 2. A Must filled setting	Specify the Signal Active Time. It could be from 1 to 10 seconds. The Signal Active Time setting will be ignored when 'Continue Update Status' function is enabled Value Range: 1 ~ 10 seconds.
Profile	The box is unchecked by default.	Click Enable box to activate this profile setting.

4G IIoT LoRa Gateway

Save	NA	Click the Save button to save the configuration.
------	----	---

Create / Edit Digital Output (DO) Profile Rule (DI/DO support required)

Setup the Digital Output (DO) Profile rules. It supports up to a maximum of 10 profiles.

Digital Output (DO) Profile List									
ID	DO Profile Name	Description	DO Source	Normal Level	Total Signal Period (ms)	Repeat & Counter	Duty Cycle(%)	Enable	Actions

When **Add** button is applied, the **Digital Output (DO) Profile Configuration** screen will appear.

Digital Output (DO) Profile Configuration	
Item	Setting
▶ DO Profile Name	<input type="text"/>
▶ Description	<input type="text"/>
▶ DO Source	ID1 ▼
▶ Normal Level	Low ▼
▶ Total Signal Period	<input type="text" value="10"/> (ms)
▶ Repeat & Counter	<input type="checkbox"/> Enable & Counter: <input type="text" value="0"/>
▶ Duty Cycle	<input type="text"/> (%)
▶ Profile	<input checked="" type="checkbox"/> Enable
<input type="button" value="Save"/>	

Digital Output (DO) Profile Configuration		
Item	Value setting	Description
DO Profile Name	1. String format 2. A Must filled setting	Specify the DO Profile Name. Value Range: -1 ~ 32 characters.
Description	1. Any text 2. An Optional setting	Specify a brief description for the profile.
DO Source	ID1 by default	Specify the DO Source. It could be ID1 .
Normal Level	Low by default	Specify the Normal Level. It could be Low or High .
Total Signal Period	1. Numeric String format 2. A Must filled setting	Specify the Total Signal Period. Value Range: 10 ~ 10000 ms.
Repeat & Counter	The box is unchecked by default.	Check the Enable box to activate the repeated Digital Output, and specify the Repeat times. Value Range: 0 ~ 65535.
Duty Cycle	1. Numeric String format 2. A Must filled setting	Specify the Duty Cycle for the Digital Output. Value Range: 1 ~100 %.
Profile	The box is unchecked by default.	Click Enable box to activate this profile setting.
Save	N/A	Click the Save button to save the configuration.

Create / Edit Modbus Notifying Events Profile (Modbus support required)

4G IIoT LoRa Gateway

Setup the Modbus Notifying Events Profile. It supports up to a maximum of 10 profiles.

ID	Modbus Name	Description	Read Function	Modbus Mode	IP	Port	Device ID	Register	Logic Comparator	Value	Enable	Actions
----	-------------	-------------	---------------	-------------	----	------	-----------	----------	------------------	-------	--------	---------

You can click the **Add / Edit** button to configure the profile.

Item	Setting
▶ Modbus Name	<input type="text"/>
▶ Description	<input type="text"/>
▶ Read Function	Read Coils (0x01) ▼
▶ Modbus Mode	Serial ▼
▶ IP	<input type="text"/>
▶ Port	<input type="text"/>
▶ Device ID	<input type="text"/>
▶ Register	<input type="text"/>
▶ Logic Comparator	> ▼
▶ Value	<input type="text" value="0"/>
▶ Enable	<input checked="" type="checkbox"/> Enable

Item	Value setting	Description
Modbus Name	1. String format 2. A Must filled setting	Specify the Modbus profile name. Value Range: -1 ~ 32 characters.
Description	1. Any text 2. An Optional setting	Specify a brief description for the profile.
Read Function	Read Holding Registers by default	Specify the Read Function for Notifying Events .
Modbus Mode	Serial by default	Specify the Modbus Mode. It could be Serial or TCP .
IP	1. NA for Serial on Modbus Mode. 2. A Must filled setting for TCP on Modbus Mode.	Specify the IP for TCP on Modbus Mode. IPv4 Format.
Port	1. NA for Serial on Modbus Mode. 2. A Must filled setting for TCP on Modbus Mode.	Specify the Port for TCP on Modbus Mode. Value Range: 1 ~ 65535.
Device ID	1. Numeric String format 2. A Must filled setting	Specify the Device ID of the modbus device. It could be from 1 to 247.

4G IIoT LoRa Gateway

Register	1. Numeric String format 2. A Must filled setting	Specify the Register number of the modbus device. Value Range: 0 ~ 65535.
Logic Comparator	Logic Comparator '>' by default.	Specify the Logic Comparator for Notifying Events . It could be '>', '<', '≐', '>=', or '<='.
Value	1. Numeric String format 2. A Must filled setting	Specify the Value. Value Range: 0 ~ 65535.
Enable	The box is unchecked by default.	Click Enable box to activate this profile setting.
Save	NA	Click the Save button to save the configuration
Undo	NA	Click the Undo button to restore what you just configured back to the previous setting.

Create / Edit Modbus Managing Events Profile (Modbus support required)

Setup the Modbus Managing Events Profile. It supports up to a maximum of 10 profiles.

ID	Modbus Name	Description	Write Function	Modbus Mode	IP	Port	Device ID	Register	Value	Enable	Actions
----	-------------	-------------	----------------	-------------	----	------	-----------	----------	-------	--------	---------

You can click the **Add / Edit** button to configure the profile.

Item	Setting
▶ Modbus Name	<input type="text"/>
▶ Description	<input type="text"/>
▶ Write Function	Write Single Coil (0x05) ▼
▶ Modbus Mode	Serial ▼
▶ IP	<input type="text"/>
▶ Port	<input type="text"/>
▶ Device ID	<input type="text"/>
▶ Register	<input type="text"/>
▶ Value	0
▶ Enable	<input checked="" type="checkbox"/> Enable

Item	Value setting	Description
Modbus Name	1. String format 2. A Must filled setting	Specify the Modbus profile name. Value Range: -1 ~ 32 characters.
Description	1. Any text	Specify a brief description for the profile.

4G IIoT LoRa Gateway

	2. An Optional setting	
Write Function	Write Single Registers by default	Specify the Write Function for Managing Events .
Modbus Mode	Serial by default	Specify the Modbus Mode. It could be Serial or TCP .
IP	1. NA for Serial on Modbus Mode. 2. A Must filled setting for TCP on Modbus Mode.	Specify the IP for TCP on Modbus Mode. IPv4 Format.
Port	1. NA for Serial on Modbus Mode. 2. A Must filled setting for TCP on Modbus Mode.	Specify the Port for TCP on Modbus Mode. Value Range: 1 ~ 65535.
Device ID	1. Numeric String format 2. A Must filled setting	Specify the Device ID of the modbus device. Value Range: 1 ~ 247.
Register	1. Numeric String format 2. A Must filled setting	Specify the Register number of the modbus device. Value Range: 0 ~ 65535.
Value	1. Numeric String format 2. A Must filled setting	Specify the Value. Value Range: 0 ~ 65535.
Enable	The box is unchecked by default.	Click Enable box to activate this profile setting.
Save	NA	Click the Save button to save the configuration
Undo	NA	Click the Undo button to restore what you just configured back to the previous setting.

Create / Edit Remote Host Profile

Setup the Remote Host Profile. It supports up to a maximum of 10 profiles.

Remote Host List								
ID	Host Name	Host IP	Protocol Type	Port Number	Prefix Message	Suffix Message	Enable	Actions

You can click the **Add / Edit** button to configure the profile.

Remote Host Configuration	
Item	Setting
▶ Host Name	<input type="text"/>
▶ Host IP	<input type="text"/>
▶ Protocol Type	TCP ▼
▶ Port Number	<input type="text"/>
▶ Prefix Message	<input type="text"/>
▶ Suffix Message	<input type="text"/>
▶ Enable	<input type="checkbox"/>
<input type="button" value="Save"/>	

4G IIoT LoRa Gateway

Remote Host Configuration		
Item	Value setting	Description
Host Name	1. String format 2. A Must filled setting	Specify the Remote Host profile name. <u>Value Range:</u> -1 ~ 64 characters.
Host IP	1. A Must filled setting 2. IP Address format.	Specify the IP address for the Remote Host. IPv4 Format.
Protocol Type	1. A Must filled setting 2. TCP is selected by default	Specify the protocol to access the Remote Host. It could be TCP or UDP .
Port Number	1. A Must filled setting	Specify the Port number for accessing the Remote Host. <u>Value Range:</u> 1 ~ 65535.
Prefix Message	1. String format 2. An Optional filled setting	Specify the Prefix Message string as pre-defined identification for accessing the remote host, if required. <u>Value Range:</u> -1 ~ 64 characters.
Suffix Message	1. String format 2. An Optional filled setting	Specify the Suffix Message string as pre-defined identification for accessing the remote host, if required. <u>Value Range:</u> -1 ~ 64 characters.
Enable	The box is unchecked by default.	Click Enable box to activate this profile setting.
Save	NA	Click the Save button to save the configuration
Undo	NA	Click the Undo button to restore what you just configured back to the previous setting.

4G IIoT LoRa Gateway

Create / Edit MQTT Publish Message Profile

Setup the MQTT Publish Message Profile. It supports up to a maximum of 2 profiles.

MQTT Publish Message List						Add	Delete	↑	×
ID	Connection Name	Topic	QoS	Enable	Action				
1	Broker01	/Device_01/Event_act01	0	<input checked="" type="checkbox"/>	Publish Now Edit <input type="checkbox"/> Select				

You can click the **Add / Edit** button to configure the profile.

When **Add** button is clicked, the configuration page / **Field Communication / Data Interchange / MQTT** will be displayed and please make sure the MQTT Client is enabled for further adding any MQTT Client Connections for the MQTT Publish Message profile.

Refer to the **MQTT** section for how to configure the details of MQTT Client and Publish Message.

MQTT Client Function							↑	×
Item	Setting							
MQTT Client	<input checked="" type="checkbox"/> Enable							

MQTT Client List							Add	Delete	↑
ID	Connection Name	Address	Authentication	Security	Port	Enable	Action		
1	Broker01	1.2.3.4	<input type="checkbox"/>	None	1883	<input checked="" type="checkbox"/>	Subscriptions Received List Edit <input type="checkbox"/> Select		

For the message to be published via Managing Event or Notifying Event, you have to configure the **Message Style** as “Manual” and further specify the message content as well. Besides, leave the **Publish Behavior** (Auto Publish) unchecked. Refer to the example highlighted in the following snapshot.

Publish Message Configuration		Save	Undo
Item	Setting		
Topic	<input type="text" value="/Device_01/Event_act01"/>		
Topics prefix	<input type="checkbox"/> Enable		
Message Style	Manual		
Message	<input type="text" value="Event_act01 triggered!"/>		
QoS	<input checked="" type="radio"/> 0 (At most once) <input type="radio"/> 1 (At least once) <input type="radio"/> 2 (Exactly once)		
Retained	<input type="checkbox"/> Enable		
Publish Behavior	<input type="checkbox"/> Auto Publish		
Enable	<input checked="" type="checkbox"/>		

4G IIoT LoRa Gateway

7.2.2 Managing Events

Managing Events allow administrator to define the relationship (rule) among event trigger, handlers and response.

Go to **Service > SMS & Event > Managing Events** Tab.

Enable Managing Events

Configuration	
Item	Setting
Managing Events	<input type="checkbox"/> Enable

Configuration		
Item	Value setting	Description
Managing Events	The box is unchecked by default	Check the Enable box to activate the Managing Events function.

Create / Edit Managing Event Rules

Setup the Managing Event rules. It supports up to a maximum of 128 rules.

Managing Event List						
ID	Event Name	Event	Trigger Type	Description	Enable	Actions

When **Add** or **Edit** button is applied, the **Managing Event Configuration** screen will appear.

4G IIoT LoRa Gateway

Managing Event Configuration
✕

Item	Setting
▶ Event Name	<input style="width: 80%;" type="text"/>
▶ Event	<div style="margin-bottom: 5px;"><input type="text" value="None"/> ▼</div> <div style="margin-bottom: 5px;"><input type="text" value="None"/> ▼</div> <div style="margin-bottom: 5px;"><input type="text" value="None"/> ▼</div>
▶ Trigger Type	<input type="text" value="Period"/> ▼
▶ Interval	<input style="width: 50%;" type="text" value="0"/> (0~86400 seconds)
▶ Description	<input style="width: 95%;" type="text"/>
▶ Action	<input type="checkbox"/> Network Status <input type="checkbox"/> LAN&VLAN <input type="checkbox"/> NAT <input type="checkbox"/> Firewall <input type="checkbox"/> VPN <input type="checkbox"/> GRE <input type="checkbox"/> System Manage <input type="checkbox"/> Administration <input type="checkbox"/> Digital Output <input type="checkbox"/> Modbus <input type="checkbox"/> Remote Host <input type="checkbox"/> MQTT
▶ Managing Event	<input checked="" type="checkbox"/> Enable

Managing Event Configuration		
Item	Value setting	Description
Event Name	Blank by default	Specify a name or identifier for this managing event rule. Value Range: 0 ~ 64 characters.
Event	None by default	Specify the Event type (SMS , SNMP Trap , or Digital Input) and an event identifier / profile. Up to 3 event conditions can be specified for defining an event, and the event will be triggered when all the conditions hold simultaneously (AND relation). The supported Event types could be: SMS: Select SMS and fill the message in the textbox to as the trigger condition for the event; SNMP: Select SNMP Trap and fill the message in the textbox to specify SNMP Trap Event; Digital Input: Select Digital Input and a DI profile you defined to specify a certain Digital Input Event; <i>Note: The available Event Type could be different for the purchased product.</i>
Trigger Type	Period is selected by default	Specify the type of event trigger, either Period or Once . Period: Select Period and specify a time interval, the event will be repeatedly triggered on every time interval when the specified event condition holds. Once: Select Once and the event will be just triggered just one time when the

4G IIoT LoRa Gateway

		specified event condition holds.
Interval	0 is set by default	Specify the repeatedly event trigger time interval. <u>Value Range:</u> 0 ~86400 seconds.
Description	String format : any text.	Enter a brief description for the Managing Event.
Action	All box is unchecked by default.	Specify Network Status , or at least one rest action to take when the expected event is triggered. Network Status: Select Network Status Checkbox to get the network status as the action for the event; LAN&VLAN: Select LAN&VLAN Checkbox and the interested sub-items (Port link On/Off), the gateway will change the settings as the action for the event; WiFi: Select WiFi Checkbox and the interested sub-items (WiFi radio On/Off), the gateway will change the settings as the action for the event; NAT: Select NAT Checkbox and the interested sub-items (Virtual Server Rule On/Off, DMZ On/Off), the gateway will change the settings as the action for the event; Firewall: Select Firewall Checkbox and the interested sub-items (Remote Administrator Host ID On/Off), the gateway will change the settings as the action for the event; VPN: Select VPN Checkbox and the interested sub-items (IPSec Tunnel ON/Off, PPTP Client On/Off, L2TP Client On/Off, OpenVPN Client On/Off), the gateway will change the settings as the action for the event; GRE: Select GRE Checkbox and the interested sub-items (GRE Tunnel On/Off), the gateway will change the settings as the action for the event; System Manage: Select System Manage Checkbox and the interested sub-items (WAN SSH Service On/Off, TR-069 On/Off), the gateway will change the settings as the action for the event; Administration: Select Administration Checkbox and the interested sub-items (Backup Config, Restore Config, Reboot, Save Current Setting as Default), the gateway will change the settings as the action for the event; Digital Output: Select Digital Output checkbox and a DO profile you defined as the action for the event; Modbus: Select Modbus checkbox and a Modbus Managing Event profile you defined as the action for the event; Remote Host: Select Remote Host checkbox and a Remote Host profile you defined as the action for the event; MQTT: Select MQTT checkbox and a MQTT Publish Message profile you defined as the action for the event; <i>Note: The available Event Type could be different for the purchased product.</i>
Managing Event	The box is unchecked by default.	Click Enable box to activate this Managing Event setting.
Save	NA	Click the Save button to save the configuration
Undo	NA	Click the Undo button to restore what you just configured back to the previous setting.

4G IIoT LoRa Gateway

7.2.3 Notifying Events

Go to **Service > SMS & Event > Notifying Events** Tab.

Notifying Events Setting allows administrator to define the relationship (rule) between event trigger and handlers.

Enable Notifying Events

Configuration	
Item	Setting
▶ Notifying Events	<input type="checkbox"/> Enable

Configuration		
Item	Value setting	Description
Notifying Events	The box is unchecked by default	Check the Enable box to activate the Notifying Events function.

Create / Edit Notifying Event Rules

Setup your Notifying Event rules. It supports up to a maximum of 128 rules.

Notifying Event List								
ID	Event Name	Event	Trigger Type	Description	Action	Time Schedule	Enable	Actions

When **Add** or **Edit** button is applied, the **Notifying Event Configuration** screen will appear.

4G IIoT LoRa Gateway

Notifying Event Configuration
✕

Item	Setting
▶ Event Name	<input style="width: 80%;" type="text"/>
▶ Event	<div style="margin-bottom: 2px;"><input type="text" value="None"/> ▼</div> <div style="margin-bottom: 2px;"><input type="text" value="None"/> ▼</div> <div style="margin-bottom: 2px;"><input type="text" value="None"/> ▼</div>
▶ Trigger Type	<input type="text" value="Period"/> ▼
▶ Interval	<input style="width: 40%;" type="text" value="0"/> (0~86400 seconds)
▶ Description	<input style="width: 95%;" type="text"/>
▶ Action	<input type="checkbox"/> Digital Output <input type="checkbox"/> SMS <input type="checkbox"/> Syslog <input type="checkbox"/> SNMP Trap (Only Support v1 and v2c) <input type="checkbox"/> Email Alert <input type="checkbox"/> Modbus <input type="checkbox"/> Remote Host <input type="checkbox"/> MQTT
▶ Time Schedule	<input type="text" value="(0) Always"/> ▼
▶ Notifying Events	<input checked="" type="checkbox"/> Enable

Notifying Event Configuration		
Item	Value setting	Description
Event Name	Blank by default	Specify a name or identifier for this notifying event rule. Value Range: 0 ~ 64 characters.
Event	None by default	Specify the Event type and corresponding event configuration. Up to 3 event conditions can be specified for defining an event, and the event will be triggered when all the conditions hold simultaneously (AND relation). The supported Event Type could be: Digital Input: Select Digital Input and a DI profile you defined to specify a certain Digital Input Event; Power Change: Select Power Change and a trigger condition to specify the event on a certain power source. WAN: Select WAN and a trigger condition to specify a certain WAN Event; LAN&VLAN: Select LAN&VLAN and a trigger condition to specify a certain LAN&VLAN Event; WiFi: Select WiFi and a trigger condition to specify a certain WiFi Event; DDNS: Select DDNS and a trigger condition to specify a certain DDNS Event; Administration: Select Administration and a trigger condition to specify a certain Administration Event; Modbus: Select Modbus and a Modbus Notifying Event profile you defined to specify a certain Modbus Event; Data Usage: Select Data Usage , the SIM Card (Cellular Service) and a trigger condition to specify a certain Data Usage Event;

4G IIoT LoRa Gateway

		<i>Note: The available Event Type could be different for the purchased product.</i>
Description	String format : any text.	Enter a brief description for the Notifying Event.
Action	All box is unchecked by default.	<p>Specify at least one action to take when the expected event is triggered.</p> <p>Digital Output: Select Digital Output checkbox and a DO profile you defined as the action for the event;</p> <p>SMS: Select SMS, and the gateway will send out a SMS to all the defined SMS accounts as the action for the event;</p> <p>Syslog: Select Syslog and select/unselect the Enable Checkbox to as the action for the event;</p> <p>SNMP Trap: Select SNMP Trap, and the gateway will send out SNMP Trap to the defined SNMP Event Receivers as the action for the event;</p> <p>Email Alert: Select Email Alert, and the gateway will send out an Email to the defined Email accounts as the action for the event;</p> <p>Modbus: Select Modbus and a Modbus Notifying Event profile you defined as the action for the event;</p> <p>Remote Host: Select Remote Host checkbox and a Remote Host profile you defined as the action for the event;</p> <p>MQTT: Select MQTT checkbox and a MQTT Publish Message profile you defined as the action for the event;</p>
		<i>Note: The available Event Type could be different for the purchased product.</i>
Time Schedule	(0) Always is selected by default	Select a time scheduling rule for the Notifying Event.
Notifying Events	The box is unchecked by default.	Click Enable box to activate this Notifying Event setting.
Save	NA	Click the Save button to save the configuration
Undo	NA	Click the Undo button to restore what you just configured back to the previous setting.

4G IIoT LoRa Gateway

7.3 LoRa

LoRa Technology

LoRa is a long range wireless data communication technology developed by Semtech. LoRa uses license-free sub-gigahertz radio frequency bands like 433 MHz, 868 MHz (Europe) and 915 MHz (North America). LoRa enables very-long-range transmissions (more than 10 km in rural areas) with low power consumption. The technology is presented in two parts — LoRa, the physical layer and LoRaWAN, the upper layers.¹²

Semtech builds LoRa Technology into its chipsets. These chipsets are then built into the commercial products, LoRa Gateway and LoRa Nodes, and integrated into LPWANs service by worldwide ISPs.

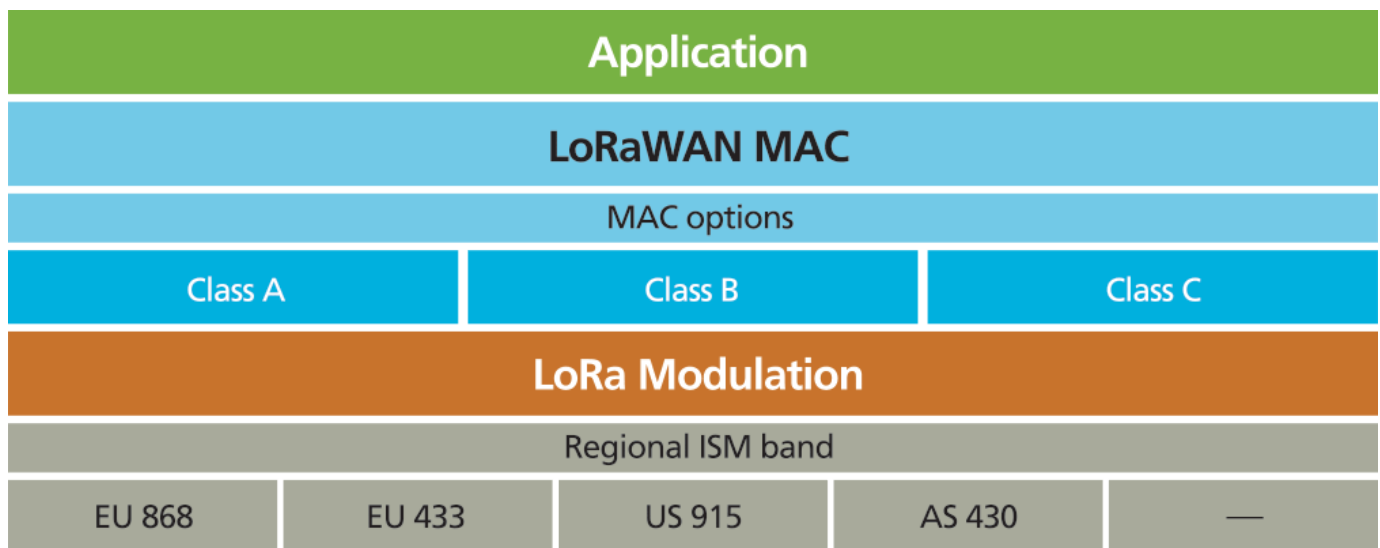

¹² <https://www.semtech.com/technology/lora/what-is-lora>

4G IIoT LoRa Gateway

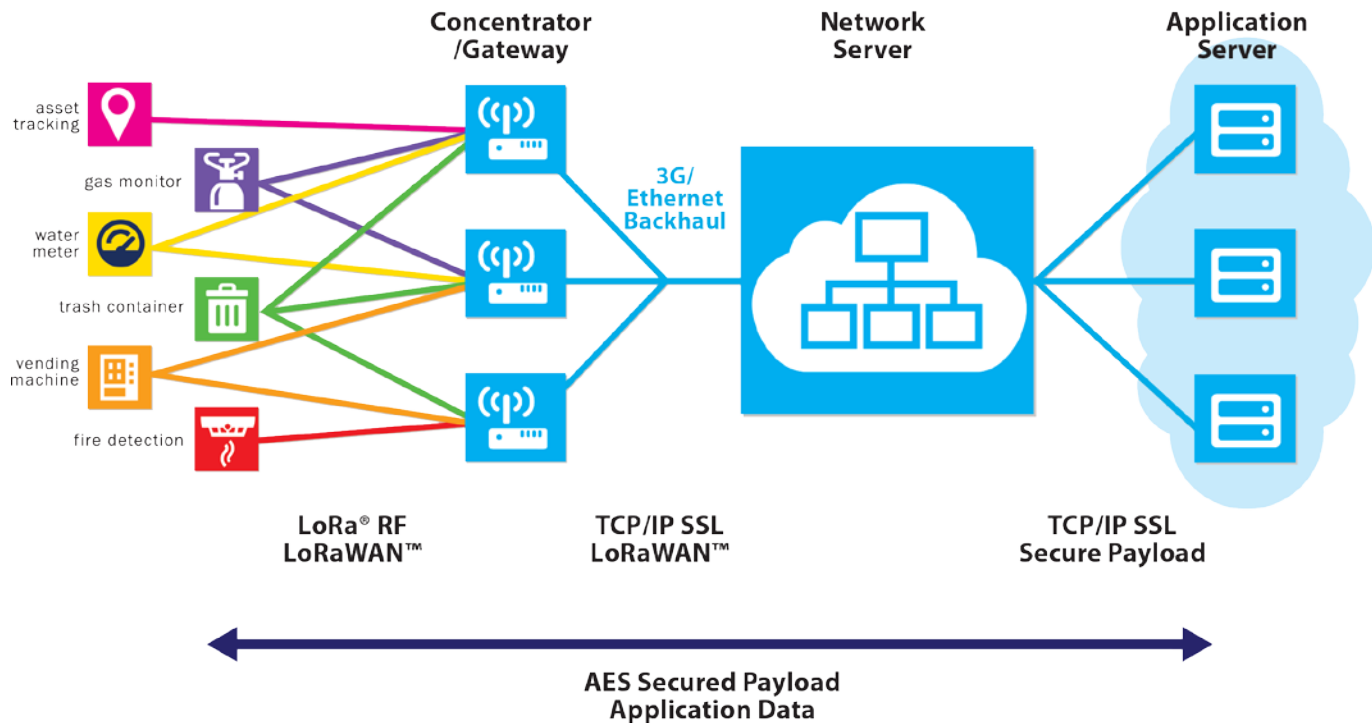

LoRaWAN Protocol

LoRaWAN is a protocol specification built on top of the LoRa technology developed by the LoRa Alliance. It uses unlicensed radio spectrum in the Industrial, Scientific and Medical (ISM) bands to enable low power, wide area communication between remote sensors and gateways connected to the network. This standard-based approach to building a LPWA network allows for quick set up of public or private IoT networks anywhere using hardware and software that is bi-directionally secure, interoperable and mobile, provides accurate localization, and works the way you expect.

LoRaWAN defines the communication protocol and system architecture for the network, while the LoRa physical layer enables the long-range communication link. LoRaWAN is also responsible managing the communication frequencies, data rate, and power for all devices. Devices in the network are asynchronous and transmit when they have data available to send. Data transmitted by an end-node device is received by multiple gateways, which forward the data packets to a centralized network server. The network server filters duplicate packets, performs security checks, and manages the network. Data is then forwarded to application servers.

As depicted in the LoRaWAN network diagram, all the application data between the end nodes and application server are AES-encrypted. The LoRa gateway and network server are merely responsible for data forwarding and security checks, they know nothing about the encrypted data transferred.

4G IIoT LoRa Gateway

7.3.1 LoRa Gateway

This product is integrated with an 8-channel LoRa Gateway module. With some basic configuration and specified an accompanied network server, the LoRa Gateway can connect with surrounding LoRa Nodes and forward the received data to Network Server for further processing.

LoRa Gateway Setting

Go to **Service > LoRa > LoRa Gateway** Tab.

The LoRa Gateway setting page enables user to configure the embedded LoRa gateway, and allow packet forwarding from LoRa nodes to Network Server, or from Network Server to LoRa Nodes.

LoRa Configuration

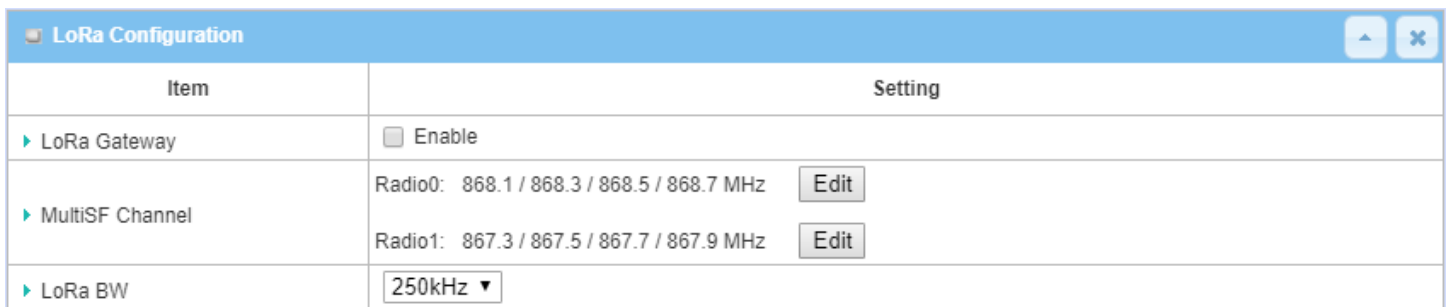

Item	Setting
▶ LoRa Gateway	<input type="checkbox"/> Enable
▶ MultiSF Channel	Radio0: 868.1 / 868.3 / 868.5 / 868.7 MHz <input type="button" value="Edit"/>
	Radio1: 867.3 / 867.5 / 867.7 / 867.9 MHz <input type="button" value="Edit"/>
▶ LoRa BW	250kHz ▼

LoRa Configuration		
Item	Value setting	Description
LoRa Gateway	The box is unchecked by default	Check Enable box to activate the LoRa Gateway function.
MultiSF Channel	Some channels are selected by default	Select the RF channels to be activated. The LoRa gateway supports up to 8 LoRa channels, defined in Radio0 and Radio1 , for connecting with LoRa Nodes. For each Radio, you can select up to four channels to operate. Note: The supported operation band list is hardware dependent. It depends on the hardware version and regional regulation. EU868 Frequency Plan: 868.1 / 868.3 / 868.5 / 868.7 / 878.9 / 867.1/ 867.3 / 867.5 / 867.7 / 867.9 MHz US915 Frequency Plan: 902.3 / 902.5 / 902.7 / 902.9 / 903.1 / 903.3 / 903.5 / 903.7 / 903.9 MHz AS923 Frequency Plan: 903.0 / 903.2 / 923.4 / 923.6 / 923.8 / 924.0 / 924.2 / 924.4 / 924.6 MHz
LoRa BW	250kHz is selected by	Select theLoRa BW (bandwidth) for the RF channel allocation.

4G IIoT LoRa Gateway

	default.	The default setting is 250kHz for EU band, 500kHz for US band. <i>Value Range:</i> 125kHz, 250kHz, or 500kHz.
Save	NA	Click the Save button to save the configuration

Network Server Configuration

Network Server
⏪ ⏩ ✕

Item	Setting
▶ Gateway ID	<input style="width: 80%;" type="text" value="00501821F3AE0000"/>
▶ Keep Alive Interval	<input style="width: 40%;" type="text" value="5"/> (seconds)

Network Server Configuration		
Item	Value setting	Description
Gateway ID	String format: MAC-like string, with eight 2-digit hex. numbers	Enter an unique ID for the LoRa Gateway. It will be used for communicating with Network Server. Please enter the WAN MAC for the device, and followed with two extra numbers. For example, WAN MAC is 00:50:18:00:08:FE, then input "00:50:18:00:08:FE:11:22" as the Gateway ID.
Keep Alive Interval	A Must filled setting 5 seconds set by default	Specify the time interval (seconds) to keep the connection alive between network server and LoRa gateway even there is no LoRa traffic. <i>Value Range:</i> 5 ~ 999 seconds.
Save	NA	Click the Save button to save the configuration

4G IIoT LoRa Gateway

7.3.2 LoRa Network Server

For the small scale or private applications, you don't want to use third party's public LoRaWAN network service (bind to a certain LoRa Network Server, Application Server) that is provided by local Telco or ISP. In such case, you will need a private network server for collecting all the data from your deployed LoRa nodes.

This product is integrated with a private LoRa Network Server, and also a simplified Application Server. It supports up to 300 LoRa Nodes. If you intend to use the embedded network server for your private application, you have to proceed with following LoRa Network Server settings.

After that, the collected data from your LoRa nodes is collected and stored in an embedded SQL database. You can access to it with the LAN IP and port 9999.

Note: To customize your application with the product for two-way communication with the Class C LoRa nodes, you may need to get further SDK from the gateway vendor to link with your own application or managing platform.

LoRa Network Server

Go to **Service > LoRa > LoRa Network Server** Tab.

The LoRa Network Server setting page enables user to configure the LoRa network server, and optionally register the LoRa nodes to the internal LoRa Network Server, when available, to get permissible access.

LoRa Network Server Configuration

LoRa Configuration	
Item	Setting
▶ LoRa Network Server	<input type="checkbox"/> Enable
▶ Server Port	<input type="text" value="1700"/>
▶ Lora Message Database	<input checked="" type="checkbox"/> Enable
▶ Internal / External	<input type="text" value="External"/> Server: <input type="text" value="--- Option ---"/> <input type="button" value="Add Object"/>

LoRa Configuration		
Item	Value setting	Description
LoRa Network Server	The box is unchecked by default	Check Enable box to activate the embedded LoRa Network Server.
Server Port	A Must filled setting Port 1700 set by default	Specify a Port Number as destination port for sending packets. Value Range: 1 ~ 65535.
LoRa Message	The box is checked by	Check Enable box to activate the embedded LoRa Message Database. The

4G IIoT LoRa Gateway

Database	default	database can keep up to 600,000 records from connected LoRa nodes. Once the records exceed the limit, half of the records will be deleted for recording further messages.
Internal / External	Default value depends on product spec.	<p>Specify the type of LoRa network server to be connected.</p> <p>External: Select a LoRa network server, provided by the LoRa Networking Service Provider, to process the packets to/from the LoRa gateway. When the External server is selected, you have to further select a pre-defined server profile from the dropdown list, or click the Add Object button to define the server information to the external LoRa Network Server. Refer to Section 3.4 External Server for the details.</p> <p>Internal: Select the internal LoRa network server, embedded with the LoRa Gateway device to process the packets to/from the LoRa gateway.</p> <p>Note: Depending on the purchase model, the supported interface type could be Internal or External. Some model just supports External network server.</p>

Register LoRa Nodes

If you enabled the internal LoRa Network Server, you have to further register all the LoRa Nodes that you are going to deploy in you application sites. It supports up to 300 LoRa Nodes. For the data packets coming from un-registered LoRa nodes, it will be ignored accordingly.

If you are not familiar with the following terms or items required for registering your LoRa node, you can refer to a good article that can be found in a Blog in NEWIE VENTURES web page¹³.

You can maintain and see all the registered LoRa nodes in the LoRa Node list.

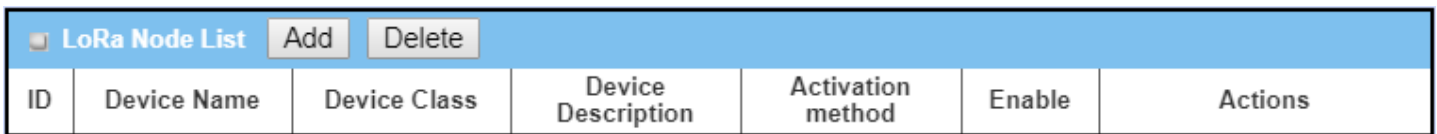

ID	Device Name	Device Class	Device Description	Activation method	Enable	Actions
----	-------------	--------------	--------------------	-------------------	--------	---------

When **Add** or **Edit** button is applied, the **LoRa Node Configuration** screen will appear.

13 <https://www.newieventures.com.au/blogtext/2018/2/26/lorawan-otaa-or-abp>

4G IIoT LoRa Gateway

LoRa Node Configuration Save Undo	
Item	Setting
▶ Device Name	<input type="text"/>
▶ Device Class	A ▼
▶ Device Description	<input type="text"/>
▶ Activation method	OTAA ▼
▶ Device EUI	<input type="text"/>
▶ Application EUI	<input type="text"/>
▶ App Key	<input type="text"/>
▶ Device Address	<input type="text"/>
▶ Network Session Key	<input type="text"/>
▶ APP Session Key	<input type="text"/>
▶ Enable	<input type="checkbox"/>

▶ Activation method	ABP ▼
▶ Device EUI	<input type="text"/>
▶ Application EUI	<input type="text"/>
▶ App Key	<input type="text"/>
▶ Device Address	<input type="text"/>
▶ Network Session Key	<input type="text"/>
▶ APP Session Key	<input type="text"/>
▶ Enable	<input type="checkbox"/>

LoRa Node Configuration		
Item	Value setting	Description
Device Name	A Must filled setting Blanked by default	Enter an unique name / identifier of the LoRa node being registered. Please enter the WAN MAC for the device, and followed with two extra numbers. Value Range: 1~16 alphanumeric characters; '-' and '_' are valid characters.
Device Class	A Must filled setting Class A is selected by default	Specify the device type of the LoRa node being registered. Currently, Class A and Class C devices are supported.
Device Description	An Optional filled setting Blanked by default	Enter a brief description for the LoRa node be registered.
Activation Method	A Must filled setting OTAA is selected by	Specify the activation method of the LoRa node being registered. OTAA (Over-the-Air Activation) and ABP (Activation by Personalization) are

4G IIoT LoRa Gateway

	default	supported. OTAA: OTAA is the preferred and most secure way to connect with network server. Devices perform a join-procedure with the network server, during which a dynamic Device Address is assigned and security keys (Network Session Key, APP Session Key) are negotiated with the device. ABP: ABP is a simpler activation method with fixed device address and security keys. For some device, it is manufactured with a hardcode Device Address as well as the security keys in the device. This means it can't worked with OTAA method. This strategy might seem simpler, because you skip the join procedure.
Device EUI	A Must filled setting Blanked by default	Enter a unique Device EUI for the LoRa node being registered. The EUI is provided by the device manufacture. <u>Value Range:</u> 16 hexadecimal characters (0~9, A~F)
Application EUI	A Must filled setting Blanked by default	Enter an identifier as the Application EUI for the application you are deploying with the LoRa nodes. For using the private LoRa Network Server, you can define your own Application EUI. <u>Value Range:</u> 16 hexadecimal characters (0~9, A~F)
App Key	A Must filled setting for OTAA scheme	Enter an Application Key, if OTAA actication is selected, to generate required session keys while the LoRa node joins or re-joins to the network. For using the private LoRa Network Server, you can define your own Application Key. <u>Value Range:</u> 32 hexadecimal characters (0~9, A~F)
Device Address	A Must filled setting for ABP scheme	Enter a unique device address for the LoRa node being retered. It is required for ABP activation scheme. <u>Value Range:</u> 8 hexadecimal characters (0~9, A~F)
Network Session Key	A Must filled setting for ABP scheme	Enter a network session key for the LoRa node being registered. The Network Server will use this key to decrypt the meta data that is transmitted from the registered LoRa nodes. It is required for ABP activation scheme. <u>Value Range:</u> 32 hexadecimal characters (0~9, A~F)
APP Session Key	A Must filled setting for ABP scheme	Enter an application session key for the LoRa node being registered. The Application Server will use this key to decrypt the packet payload that is transmitted from the registered LoRa nodes. It is required for ABP activation scheme. <u>Value Range:</u> 32 hexadecimal characters (0~9, A~F)
Enable	Unchecked by default	Check the Enable box to activate the parameters of the LoRa node being registered.
Save	NA	Click the Save button to save the configuration

Register LoRa Group Nodes

To deploy hundreds of LoRa nodes, you can register the LoRa nodes as group of LoRa nodes instead of registering one by one.

4G IIoT LoRa Gateway

You can maintain and see all the registered LoRa group nodes in the LoRa Group Node list.

LoRa Group Node List Add Delete									
ID	Device Name	Device Class	Activation method	Device Address start	Device Address end	Device EUI start	Device EUI end	Enable	Actions

When **Add** or **Edit** button is applied, the **LoRa Group Node Configuration** screen will appear.

LoRa Group Node List Save Undo	
Item	Setting
▶ Device Name	<input type="text"/>
▶ Device Class	A ▼
▶ Device Description	<input type="text"/>
▶ Activation method	OTAA ▼
▶ Device Address start	<input type="text"/>
▶ Device Address end	<input type="text"/>
▶ Device EUI start	<input type="text"/>
▶ Device EUI end	<input type="text"/>
▶ Application EUI	<input type="text"/>
▶ Network Session Key	<input type="text"/>
▶ APP Session Key	<input type="text"/>
▶ Enable	<input type="checkbox"/>

LoRa Group Node Configuration		
Item	Value setting	Description
Device Name	A Must filled setting Blanked by default	Enter an unique name / identifier of the LoRa group node being registered. Value Range: 1~16 alphanumeric characters.
Device Class	A Must filled setting Class A is selected by default	Specify the device type of the LoRa node being registered. Currently, Class A and Class C devices are supported.
Device Description	An Optional filled setting Blanked by default	Enter a brief description for the LoRa group node be registered.
Activation Method	A Must filled setting OTAA is selected by default	Specify the activation method of the LoRa node being registered. OTAA (Over-the-Air Activation) and ABP (Activation by Personalization) are supported. OTAA: OTAA is the preferred and most secure way to connect with network server. Devices perform a join-procedure with the network server, during which a dynamic Device Address is assigned and security keys (Network

4G IIoT LoRa Gateway

		<p>Session Key, APP Session Key) are negotiated with the device.</p> <p>ABP: ABP is a simpler activation method with fixed device address and security keys. For some device, it is manufactured with a hardcode Device Address as well as the security keys in the device. This means it can't worked with OTAA method. This strategy might seem simpler, because you skip the join procedure.</p>
Device Address start / Device Address end	A Must filled setting Blanked by default	<p>Specify a range of Device address, by entering the start and end address, for the LoRa group nodes. For example, 12340000 as the start address, and 1234FFFF as the end address. Any LoRa Node with Device address in this range will be regarded as a registered node.</p> <p>The address is provided by the device manufacture. It is required for ABP activation scheme.</p> <p><u>Value Range:</u> 8 hexadecimal characters (0~9, A~F)</p>
Device EUI start / Device EUI end	A Must filled setting Blanked by default	<p>Specify a range of Device EUI, by entering the start and end EUI, for the LoRa group nodes. For example, 1000123AB0100000 as the start EUI, and 1000123AB01FFFFFF as the end EUI. Any LoRa Node with Device EUI in this range will be regarded as a registered node.</p> <p>The EUI is provided by the device manufacture.</p> <p><u>Value Range:</u> 16 hexadecimal characters (0~9, A~F)</p>
Application EUI	A Must filled setting Blanked by default	<p>Enter an identifier as the Application EUI for the application you are deploying with the LoRa nodes.</p> <p>For using the private LoRa Network Server, you can define your own Application EUI.</p> <p><u>Value Range:</u> 16 hexadecimal characters (0~9, A~F)</p>
Network Session Key	A Must filled setting for ABP scheme	<p>Enter a network session key for the LoRa node being registered. The Network Server will use this key to decrypt the meta data that is transmitted from the registered LoRa nodes.</p> <p>It is required for ABP activation scheme.</p> <p><u>Value Range:</u> 32 hexadecimal characters (0~9, A~F)</p>
APP Key Session	A Must filled setting for ABP scheme	<p>Enter an application session key for the LoRa node being registered. The Application Server will use this key to decrypt the packet payload that is transmitted from the registered LoRa nodes.</p> <p>It is required for ABP activation scheme.</p> <p><u>Value Range:</u> 32 hexadecimal characters (0~9, A~F)</p>
Enable	Unchecked by default	Check the Enable box to activate the parameters of the LoRa node being registered.
Save	NA	Click the Save button to save the configuration

4G IIoT LoRa Gateway

7.3.3 Application Server

Go to **Service > LoRa > Application Server** Tab.

The Application Server setting page enables user to configure the embedded LoRa application server, and specify the information for the client server that the LoRa packet will be forward to for application-specific processing.

Specify Application Server

You can maintain and see all the available application server in the Application Server list. Up to 3 Application Server profile is supported.



ID	Application Name	Application EUI	CS FQDN	CS Port	Enable	Actions
----	------------------	-----------------	---------	---------	--------	---------

When **Add** or **Edit** button is applied, the **Application Server Configuration** screen will appear.

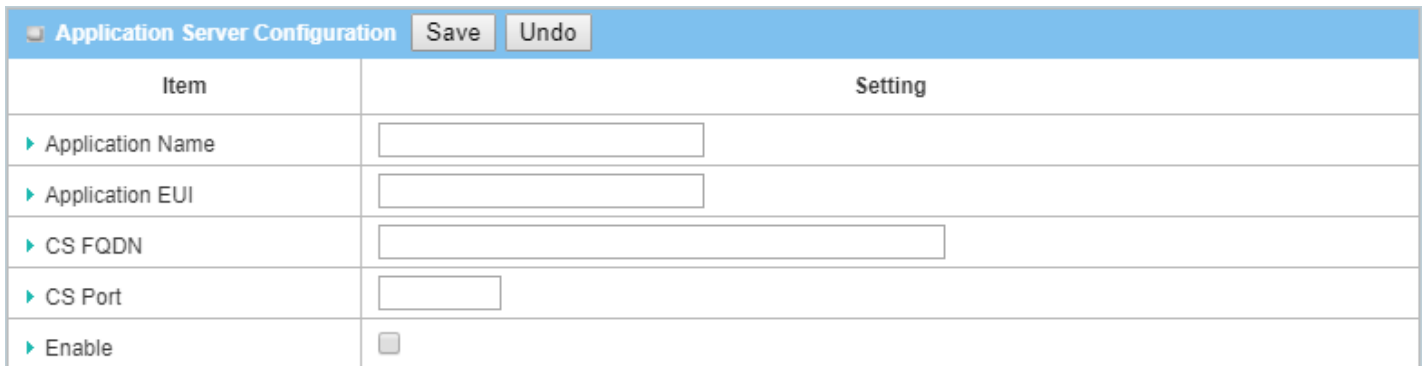

Item	Setting
▶ Application Name	<input type="text"/>
▶ Application EUI	<input type="text"/>
▶ CS FQDN	<input type="text"/>
▶ CS Port	<input type="text"/>
▶ Enable	<input type="checkbox"/>

Application Server Configuration		
Item	Value setting	Description
Application Name	A Must filled setting Blanked by default	Enter the name for the application server. <i>Value Range:</i> 1~16 alphanumeric characters; '-' and '_' are valid characters.
Application EUI	A Must filled setting Blanked by default	Enter the corresponding Application EUI for the application server. All the decrypted payloads from connected LoRa nodes with the same Application EUI setting will be forward to the designated application server. You have to further specify the CS FQDN and Port as the communication interface for final client applications <i>Value Range:</i> 16 hexadecimal characters (0~9, A~F)
CS FQDN / CS Port	A Must filled setting Blanked by default	Enter the IP address or FQDN and port number for the client application server. The application server will forward the decrypted payloads from the LoRa nodes to this designated client application server for application data processing. <i>Value Range:</i> 1 ~ 65535.

4G IIoT LoRa Gateway

Enable	Unchecked by default	Check the Enable box to activate the application server setting.
Save	NA	Click the Save button to save the configuration

4G IIoT LoRa Gateway

7.3.4 LoRa Node Log

Go to **Service > LoRa > LoRa Node Log** Tab.

The LoRa Node Log setting page enables user to do a quick check for identifying if the LoRa gateway can receive LoRa packets from registered LoRa nodes or not.

You can enable the Node Log function and check if there is any received logs from the Node Log Data list for a while. If you failed to get any data, please double check the related configurations for the LoRa gateway and your LoRa nodes.

Node Log Save ↑ ×

Item	Setting
▶ Refresh Time	<input type="checkbox"/> Enable <input type="text" value="30"/>

Node Log Data ↑ ×

Time	DevEUI	Data
1970/01/01 08:00:03	00501811223349	243214567899584742456745
2019/02/20 14:02:27	00501811223345	243214567899584742456746
2019/02/20 14:03:48	00501811223346	243214567899584742456747

Chapter 8 Status

8.1 Dashboard



8.1.1 Device Dashboard

The **Device Dashboard** window shows the current status in graph or tables for quickly understanding the operation status for the gateway. They are the System Information, System Information History, and Network Interface Status. The display will be refreshed once per second.

From the menu on the left, select **Status > Dashboard > Device Dashboard** tab.

System Information Status

The **System Information** screen shows the device Up-time and the resource utilization for the CPU, Memory, and Connection Sessions.

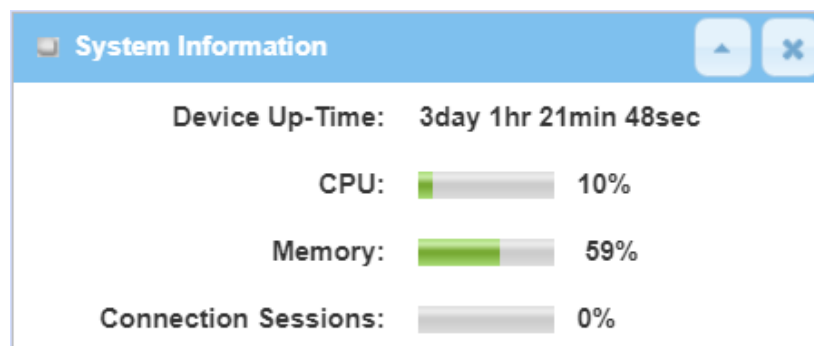

4G IIoT LoRa Gateway

System Information History

The **System Information History** screen shows the statistic graphs for the CPU and memory.

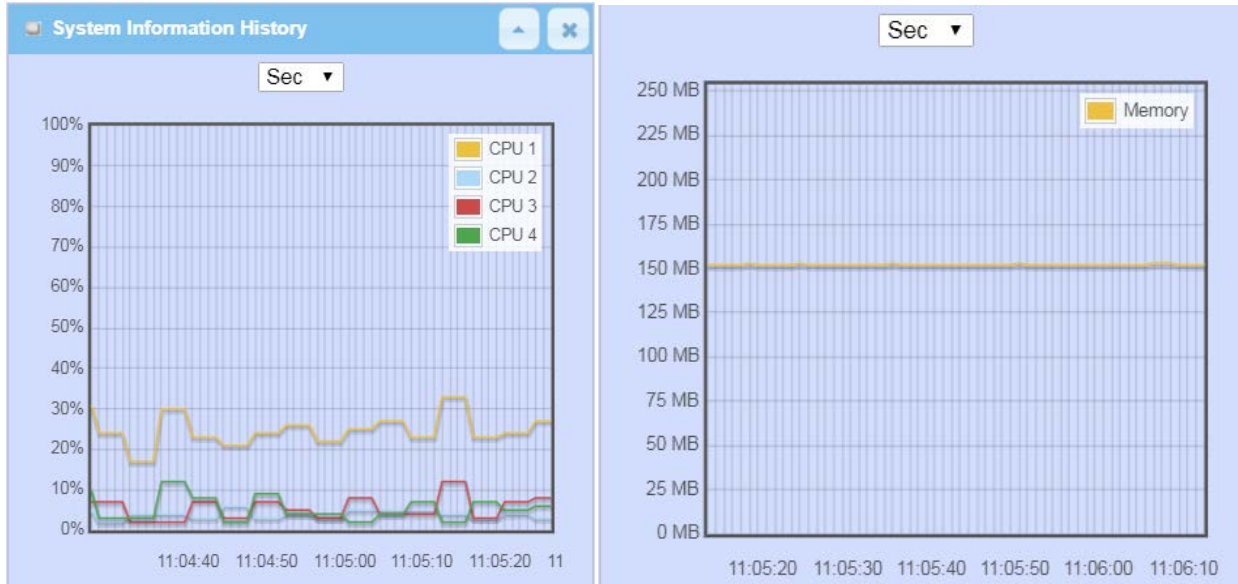

Network Interface Status

The **Network Interface Status** screen shows the statistic information for each network interface of the gateway. The statistic information includes the Interface Type, Upload Traffic, Download Traffic, and Current Upload / Download Traffic.

Device	Type	Upload Traffic	Download Traffic	Current Upload Traffic	Current Download Traffic
eth2	Ethernet	211 (MB)	321 (MB)	3 (KB)	3 (KB)
eth2.1	Ethernet	24 (MB)	71 (KB)	64 (Bytes)	0 (Bytes)
eth2.2	Ethernet	168 (MB)	283 (MB)	3 (KB)	3 (KB)
br0	Ethernet	19 (MB)	31 (MB)	42 (Bytes)	0 (Bytes)
ra0	Wireless LAN	1 (MB)	1 (MB)	0 (Bytes)	0 (Bytes)
rai0	Wireless LAN	21 (MB)	42 (MB)	0 (Bytes)	0 (Bytes)
ra1	Wireless LAN	0 (Bytes)	0 (Bytes)	0 (Bytes)	0 (Bytes)
rai1	Wireless LAN	362 (Bytes)	4 (KB)	0 (Bytes)	0 (Bytes)
tun0	Ethernet	0 (Bytes)	0 (Bytes)	0 (Bytes)	0 (Bytes)

4G IIoT LoRa Gateway

8.2 Basic Network

8.2.1 WAN & Uplink Status

Go to **Status > Basic Network > WAN & Uplink** tab.

The **WAN & Uplink Status** window shows the current status for different network type, including network configuration, connecting information, modem status and traffic statistics. The display will be refreshed on every five seconds.

WAN interface IPv4 Network Status

WAN interface IPv4 Network Status screen shows status information for IPv4 network.

WAN Interface IPv4 Network Status										
ID	Interface	WAN Type	Network Type	IP Addr.	Subnet Mask	Gateway	DNS	MAC Address	Conn. Status	Action
WAN-1	3G/4G	3G/4G	NAT	10.59.152.73	255.255.255.252	10.59.152.74	168.95.1.1, 168.95.192.1	N/A	Connected 0 day 0:26:38	Edit
WAN-2		Disable								Edit

WAN interface IPv4 Network Status		
Item	Value setting	Description
ID	N/A	It displays corresponding WAN interface WAN IDs.
Interface	N/A	It displays the type of WAN physical interface. Depending on the model purchased, it can be Ethernet, 3G/4G, etc...
WAN Type	N/A	It displays the method which public IP address is obtained from your ISP. Depending on the model purchased, it can be Static IP, Dynamic IP, PPPoE, PPTP, L2TP, 3G/4G.
Network Type	N/A	It displays the network type for the WAN interface(s). Depending on the model purchased, it can be NAT, Routing, Bridge, or IP Pass-through.
IP Addr.	N/A	It displays the public IP address obtained from your ISP for Internet connection. Default value is 0.0.0.0 if left unconfigured.
Subnet Mask	N/A	It displays the Subnet Mask for public IP address obtained from your ISP for Internet connection. Default value is 0.0.0.0 if left unconfigured.
Gateway	N/A	It displays the Gateway IP address obtained from your ISP for Internet connection. Default value is 0.0.0.0 if left unconfigured.
DNS	N/A	It displays the IP address of DNS server obtained from your ISP for Internet connection. Default value is 0.0.0.0 if left unconfigured.
MAC Address	N/A	It displays the MAC Address for your ISP to allow you for Internet access. Note: Not all ISP may require this field.
Conn. Status	N/A	It displays the connection status of the device to your ISP.

4G IIoT LoRa Gateway

		Status are Connected or disconnected.
		This area provides functional buttons.
		Renew button allows user to force the device to request an IP address from the DHCP server. Note: Renew button is available when DHCP WAN Type is used and WAN connection is disconnected.
		Release button allows user to force the device to clear its IP address setting to disconnect from DHCP server. Note: Release button is available when DHCP WAN Type is used and WAN connection is connected.
Action	N/A	<p>Connect button allows user to manually connect the device to the Internet. Note: Connect button is available when Connection Control in WAN Type setting is set to Connect Manually (Refer to Edit button in Basic Network > WAN & Uplink > Internet Setup) and WAN connection status is disconnected.</p> <p>Disconnect button allows user to manually disconnect the device from the Internet. Note: Connect button is available when Connection Control in WAN Type setting is set to Connect Manually (Refer to Edit button in Basic Network > WAN & Uplink > Internet Setup) and WAN connection status is connected.</p>

WAN interface IPv6 Network Status

WAN interface IPv6 Network Status screen shows status information for IPv6 network.

WAN Interface IPv6 Network Status						
ID	Interface	WAN type	Link-local IP Address	Global IP Address	Conn. Status	Action
WAN-1	3G/4G	IPv6		/64	Disconnected	<input type="button" value="Edit"/>

WAN interface IPv6 Network Status		
Item	Value setting	Description
ID	N/A	It displays corresponding WAN interface WAN IDs.
Interface	N/A	It displays the type of WAN physical interface. Depending on the model purchased, it can be Ethernet, 3G/4G, etc...
WAN Type	N/A	It displays the method which public IP address is obtained from your ISP. WAN type setting can be changed from Basic Network > IPv6 > Configuration .
Link-local IP Address	N/A	It displays the LAN IPv6 Link-Local address.
Global IP Address	N/A	It displays the IPv6 global IP address assigned by your ISP for your Internet connection.
Conn. Status	N/A	It displays the connection status. The status can be connected, disconnected and connecting.
Action	N/A	This area provides functional buttons. Edit Button when pressed, web-based utility will take you to the IPv6

4G IIoT LoRa Gateway

configuration page. (**Basic Network > IPv6 > Configuration.**)

LAN Interface Network Status

LAN Interface Network Status screen shows IPv4 and IPv6 information of LAN network.

LAN Interface Network Status					
IPv4 Address	IPv4 Subnet Mask	IPv6 Link-local Address	IPv6 Global Address	MAC Address	Action
192.168.66.1	255.255.254.0	fe80::250:18ff:fe3a:4a5f	/64	00:50:18:3A:4A:5F	Edit IPv4 Edit IPv6

LAN Interface Network Status		
Item	Value setting	Description
IPv4 Address	N/A	It displays the current IPv4 IP Address of the gateway This is also the IP Address user use to access Router's Web-based Utility.
IPv4 Subnet Mask	N/A	It displays the current mask of the subnet.
IPv6 Link-local Address	N/A	It displays the current LAN IPv6 Link-Local address. This is also the IPv6 IP Address user use to access Router's Web-based Utility.
IPv6 Global Address	N/A	It displays the current IPv6 global IP address assigned by your ISP for your Internet connection.
MAC Address	N/A	It displays the LAN MAC Address of the gateway
Action	N/A	This area provides functional buttons. Edit IPv4 Button when press, web-based utility will take you to the Ethernet LAN configuration page. (Basic Network > LAN & VLAN > Ethernet LAN tab). Edit IPv6 Button when press, web-based utility will take you to the IPv6 configuration page. (Basic Network > IPv6 > Configuration.)

3G/4G Modem Status

3G/4G Modem Status List screen shows status information for 3G/4G WAN network(s).

3G/4G Modem Status List					
Interface	Card Information	Link Status	Signal Strength	Network Name	Action
3G/4G	ZM8620	Connected	70% (-69dBm)	Chunghwa Telecom (LTE)	Detail

3G/4G Modem Status List		
Item	Value setting	Description
Physical Interface	N/A	It displays the type of WAN physical interface. Note: Some device model may support two 3G/4G modules. Their physical interface name will be 3G/4G-1 and 3G/4G-2 .

4G IIoT LoRa Gateway

Card Information	N/A	It displays the vendor's 3G/4G modem model name.
Link Status	N/A	It displays the 3G/4G connection status. The status can be Connecting, Connected, Disconnecting, and Disconnected.
Signal Strength	N/A	It displays the 3G/4G wireless signal level.
Network Name	N/A	It displays the name of the service network carrier.
Refresh	N/A	Click the Refresh button to renew the information.
Action	N/A	This area provides functional buttons. Detail Button when press, windows of detail information will appear. They are the Modem Information, SIM Status, and Service Information. Refer to next page for more.

When the **Detail** button is pressed, 3G/4G modem information windows such as Modem Information, SIM Status, Service Information, Signal Strength / Quality, and Error Message will appear.

Interface Traffic Statistics

Interface Traffic Statistics screen displays the Interface's total transmitted packets.

Interface Traffic Statistics				
ID	Interface	Received Packets(Mb)	Transmitted Packets(Mb)	Action
WAN-1	3G/4G	217.13	167.09	<input type="button" value="Reset"/>
WAN-2		-	-	

Interface Traffic Statistics		
Item	Value setting	Description
ID	N/A	It displays corresponding WAN interface WAN IDs.
Interface	N/A	It displays the type of WAN physical interface. Depending on the model purchased, it can be Ethernet, 3G/4G, etc...
Received Packets (Mb)	N/A	It displays the downstream packets (Mb). It is reset when the device is rebooted.
Transmitted Packets (Mb)	N/A	It displays the upstream packets (Mb). It is reset when the device is rebooted.

4G IIoT LoRa Gateway

8.2.2 LAN & VLAN Status

Go to **Status > Basic Network > LAN & VLAN** tab.

Client List

The **Client List** shows you the LAN Interface, IP address, Host Name, MAC Address, and Remaining Lease Time of each device that is connected to this gateway.

LAN Client List				
LAN Interface	IP Address	Host Name	MAC Address	Remaining Lease Time
Ethernet	Dynamic / 192.168.66.100	amit25613572	00-13-3B-0E-5B-1D	00:15:00

LAN Client List		
Item	Value setting	Description
LAN Interface	N/A	Client record of LAN Interface. String Format.
IP Address	N/A	Client record of IP Address Type and the IP Address. Type is String Format and the IP Address is IPv4 Format.
Host Name	N/A	Client record of Host Name. String Format.
MAC Address	N/A	Client record of MAC Address. MAC Address Format.
Remaining Lease Time	N/A	Client record of Remaining Lease Time. Time Format.

4G IIoT LoRa Gateway

8.2.3 WiFi Status (not supported)

Not supported feature for the purchased product, leave it as blank.

4G IIoT LoRa Gateway

8.2.4 DDNS Status

Go to **Status > Basic Network > DDNS** tab.

The **DDNS Status** window shows the current DDNS service in use, the last update status, and the last update time to the DDNS service server.

DDNS Status

DDNS Status List				
Host Name	Provider	Effective IP	Last Update Status	Last Update Time

DDNS Status		
Item	Value Setting	Description
Host Name	N/A	It displays the name you entered to identify DDNS service provider
Provider	N/A	It displays the DDNS server of DDNS service provider
Effective IP	N/A	It displays the public IP address of the device updated to the DDNS server
Last Update Status	N/A	It displays whether the last update of the device public IP address to the DDNS server has been successful (Ok) or failed (Fail).
Last Update Time	N/A	It displays time stamp of the last update of public IP address to the DDNS server.
Refresh	N/A	The refresh button allows user to force the display to refresh information.

8.3 Security

The screenshot shows the 'VPN Firewall' widget with the following data:

IPsec Tunnel Status							
ID	Tunnel Name	Tunnel Scenario	Local Subnets	Remote IP/FQDN	Remote Subnets	Conn. Time	Status
OpenVPN Server Status						Conn. Time	Status
ID	User Name	Remote IP/FQDN	Virtual IP/Mac	Conn. Time	Status		
OpenVPN Client Status							
ID	OpenVPN Client Name	Interface	Remote IP/FQDN	Remote Subnet	Virtual IP	Conn. Time	Conn. Status
1	Master_client	WAN 1	m2mcluster.de	/	172.17.0.190	00:00:00:44	Connected
L2TP Server Status						Conn. Time	Status
ID	User Name	Remote IP	Remote Virtual IP	Remote Call ID	Conn. Time	Status	
L2TP Client Status							
ID	L2TP Client Name	Interface	Virtual IP	Remote IP/FQDN	Default Gateway/Remote Subnet	Conn. Time	Status

8.3.1 VPN Status

Go to **Status > Security > VPN** tab.

The **VPN Status** window shows the overall VPN tunnel status. The display will be refreshed on every five seconds.

IPsec Tunnel Status

IPsec Tunnel Status windows show the configuration for establishing IPsec VPN connection and current connection status.

IPsec Tunnel Status							
ID	Tunnel Name	Tunnel Scenario	Local Subnets	Remote IP/FQDN	Remote Subnets	Conn. Time	Status

Item	Value setting	Description
Tunnel Name	N/A	It displays the tunnel name you have entered to identify.
Tunnel Scenario	N/A	It displays the Tunnel Scenario specified.
Local Subnets	N/A	It displays the Local Subnets specified.

4G IIoT LoRa Gateway

Remote IP/FQDN	N/A	It displays the Remote IP/FQDN specified.
Remote Subnets	N/A	It displays the Remote Subnets specified.
Conn. Time	N/A	It displays the connection time for the IPSec tunnel.
Status	N/A	It displays the Status of the VPN connection. The status displays are Connected, Disconnected, Wait for traffic, and Connecting.
Edit Button	N/A	Click on Edit Button to change IPSec setting, web-based utility will take you to the IPSec configuration page. (Security > VPN > IPSec tab)

OpenVPN Server Status

According to OpenVPN configuration, the **OpenVPN Server/Client Status** shows the status and statistics for the OpenVPN connection from the server side or client side.

ID	User Name	Remote IP/FQDN	Virtual IP/Mac	Conn. Time	Status																		
OpenVPN Server Status <table border="1"> <thead> <tr> <th>Item</th> <th>Value setting</th> <th>Description</th> </tr> </thead> <tbody> <tr> <td>User Name</td> <td>N/A</td> <td>It displays the Client name you have entered for identification.</td> </tr> <tr> <td>Remote IP/FQDN</td> <td>N/A</td> <td>It displays the public IP address (the WAN IP address) of the connected OpenVPN Client</td> </tr> <tr> <td>Virtual IP/MAC</td> <td>N/A</td> <td>It displays the virtual IP/MAC address assigned to the connected OpenVPN client.</td> </tr> <tr> <td>Conn. Time</td> <td>N/A</td> <td>It displays the connection time for the corresponding OpenVPN tunnel.</td> </tr> <tr> <td>Status</td> <td>N/A</td> <td>It displays the connection status of the corresponding OpenVPN tunnel. The status can be Connected, or Disconnected.</td> </tr> </tbody> </table>						Item	Value setting	Description	User Name	N/A	It displays the Client name you have entered for identification.	Remote IP/FQDN	N/A	It displays the public IP address (the WAN IP address) of the connected OpenVPN Client	Virtual IP/MAC	N/A	It displays the virtual IP/MAC address assigned to the connected OpenVPN client.	Conn. Time	N/A	It displays the connection time for the corresponding OpenVPN tunnel.	Status	N/A	It displays the connection status of the corresponding OpenVPN tunnel. The status can be Connected, or Disconnected.
Item	Value setting	Description																					
User Name	N/A	It displays the Client name you have entered for identification.																					
Remote IP/FQDN	N/A	It displays the public IP address (the WAN IP address) of the connected OpenVPN Client																					
Virtual IP/MAC	N/A	It displays the virtual IP/MAC address assigned to the connected OpenVPN client.																					
Conn. Time	N/A	It displays the connection time for the corresponding OpenVPN tunnel.																					
Status	N/A	It displays the connection status of the corresponding OpenVPN tunnel. The status can be Connected, or Disconnected.																					

OpenVPN Client Status

ID	OpenVPN Client Name	Interface	Remote IP/FQDN	Remote Subnet	Virtual IP	Conn. Time	Conn. Status																								
OpenVPN Client Status <table border="1"> <thead> <tr> <th>Item</th> <th>Value setting</th> <th>Description</th> </tr> </thead> <tbody> <tr> <td>OpenVPN Client Name</td> <td>N/A</td> <td>It displays the Client name you have entered for identification.</td> </tr> <tr> <td>Interface</td> <td>N/A</td> <td>It displays the WAN interface specified for the OpenVPN client connection.</td> </tr> <tr> <td>Remote IP/FQDN</td> <td>N/A</td> <td>It displays the peer OpenVPN Server's Public IP address (the WAN IP address) or FQDN.</td> </tr> <tr> <td>Remote Subnet</td> <td>N/A</td> <td>It displays the Remote Subnet specified.</td> </tr> <tr> <td>TUN/TAP Read(bytes)</td> <td>N/A</td> <td>It displays the TUN/TAP Read Bytes of OpenVPN Client.</td> </tr> <tr> <td>TUN/TAP Write(bytes)</td> <td>N/A</td> <td>It displays the TUN/TAP Write Bytes of OpenVPN Client.</td> </tr> <tr> <td>TCP/UDP</td> <td>N/A</td> <td>It displays the TCP/UDP Read Bytes of OpenVPN Client.</td> </tr> </tbody> </table>								Item	Value setting	Description	OpenVPN Client Name	N/A	It displays the Client name you have entered for identification.	Interface	N/A	It displays the WAN interface specified for the OpenVPN client connection.	Remote IP/FQDN	N/A	It displays the peer OpenVPN Server's Public IP address (the WAN IP address) or FQDN.	Remote Subnet	N/A	It displays the Remote Subnet specified.	TUN/TAP Read(bytes)	N/A	It displays the TUN/TAP Read Bytes of OpenVPN Client.	TUN/TAP Write(bytes)	N/A	It displays the TUN/TAP Write Bytes of OpenVPN Client.	TCP/UDP	N/A	It displays the TCP/UDP Read Bytes of OpenVPN Client.
Item	Value setting	Description																													
OpenVPN Client Name	N/A	It displays the Client name you have entered for identification.																													
Interface	N/A	It displays the WAN interface specified for the OpenVPN client connection.																													
Remote IP/FQDN	N/A	It displays the peer OpenVPN Server's Public IP address (the WAN IP address) or FQDN.																													
Remote Subnet	N/A	It displays the Remote Subnet specified.																													
TUN/TAP Read(bytes)	N/A	It displays the TUN/TAP Read Bytes of OpenVPN Client.																													
TUN/TAP Write(bytes)	N/A	It displays the TUN/TAP Write Bytes of OpenVPN Client.																													
TCP/UDP	N/A	It displays the TCP/UDP Read Bytes of OpenVPN Client.																													

4G IIoT LoRa Gateway

Read(bytes)		
TCP/UDP Write(bytes)	N/A	It displays the TCP/UDP Write Bytes of OpenVPN Client. Connection
Conn. Time	N/A	It displays the connection time for the corresponding OpenVPN tunnel.
Conn. Status	N/A	It displays the connection status of the corresponding OpenVPN tunnel. The status can be Connected, or Disconnected.

4G IIoT LoRa Gateway

L2TP Server/Client Status

L2TP Server/Client Status shows the configuration for establishing L2TP tunnel and current connection status.

L2TP Server Status Edit						
ID	User Name	Remote IP	Remote Virtual IP	Remote Call ID	Conn. Time	Status
L2TP Server Status						
Item	Value setting	Description				
User Name	N/A	It displays the login name of the user used for the connection.				
Remote IP	N/A	It displays the public IP address (the WAN IP address) of the connected L2TP client.				
Remote Virtual IP	N/A	It displays the IP address assigned to the connected L2TP client.				
Remote Call ID	N/A	It displays the L2TP client Call ID.				
Conn. Time	N/A	It displays the connection time for the L2TP tunnel.				
Status	N/A	It displays the Status of each of the L2TP client connection. The status displays Connected, Disconnect, Connecting				
Edit	N/A	Click on Edit Button to change L2TP server setting, web-based utility will take you to the L2TP server page. (Security > VPN > L2TP tab)				

L2TP Client Status Edit							
ID	L2TP Client Name	Interface	Virtual IP	Remote IP/FQDN	Default Gateway/Remote Subnet	Conn. Time	Status
L2TP Client Status							
Item	Value setting	Description					
Client Name	N/A	It displays Name for the L2TP Client specified.					
Interface	N/A	It displays the WAN interface with which the gateway will use to request PPTP tunneling connection to the PPTP server.					
Virtual IP	N/A	It displays the IP address assigned by Virtual IP server of L2TP server.					
Remote IP/FQDN	N/A	It displays the L2TP Server's Public IP address (the WAN IP address) or FQDN.					
Default Gateway/Remote Subnet	N/A	It displays the specified IP address of the gateway device used to connect to the internet to connect to the L2TP server –the default gateway. Or other specified subnet if the default gateway is not used to connect to the L2TP server –the remote subnet.					
Conn. Time	N/A	It displays the connection time for the L2TP tunnel.					
Status	N/A	It displays the Status of the VPN connection. The status displays Connected, Disconnect, and Connecting.					
Edit	N/A	Click on Edit Button to change L2TP client setting, web-based utility will take you to the L2TP client page. (Security > VPN > L2TP tab)					

4G IIoT LoRa Gateway

PPTP Server/Client Status

PPTP Server/Client Status shows the configuration for establishing PPTP tunnel and current connection status.

PPTP Server Status Edit						
ID	User Name	Remote IP	Remote Virtual IP	Remote Call ID	Conn. Time	Status

PPTP Server Status		
Item	Value setting	Description
User Name	N/A	It displays the login name of the user used for the connection.
Remote IP	N/A	It displays the public IP address (the WAN IP address) of the connected PPTP client.
Remote Virtual IP	N/A	It displays the IP address assigned to the connected PPTP client.
Remote Call ID	N/A	It displays the PPTP client Call ID.
Conn. Time	N/A	It displays the connection time for the PPTP tunnel.
Status	N/A	It displays the Status of each of the PPTP client connection. The status displays Connected, Disconnect, and Connecting.
Edit Button	N/A	Click on Edit Button to change PPTP server setting, web-based utility will take you to the PPTP server page. (Security > VPN > PPTP tab)

PPTP Client Status Edit							
ID	PPTP Client Name	Interface	Virtual IP	Remote IP/FQDN	Default Gateway/Remote Subnet	Conn. Time	Status

PPTP Client Status		
Item	Value setting	Description
Client Name	N/A	It displays Name for the PPTP Client specified.
Interface	N/A	It displays the WAN interface with which the gateway will use to request PPTP tunneling connection to the PPTP server.
Virtual IP	N/A	It displays the IP address assigned by Virtual IP server of PPTP server.
Remote IP/FQDN	N/A	It displays the PPTP Server's Public IP address (the WAN IP address) or FQDN.
Default Gateway / Remote Subnet	N/A	It displays the specified IP address of the gateway device used to connect to the internet to connect to the PPTP server –the default gateway. Or other specified subnet if the default gateway is not used to connect to the PPTP server –the remote subnet.
Conn. Time	N/A	It displays the connection time for the PPTP tunnel.
Status	N/A	It displays the Status of the VPN connection. The status displays Connected, Disconnect, and Connecting.
Edit Button	N/A	Click on Edit Button to change PPTP client setting, web-based utility will take you to the PPTP server page. (Security > VPN > PPTP tab)

4G IIoT LoRa Gateway

8.3.2 Firewall Status

Go to **Status > Security > Firewall Status** Tab.

The **Firewall Status** provides user a quick view of the firewall status and current firewall settings. It also keeps the log history of the dropped packets by the firewall rule policies, and includes the administrator remote login settings specified in the Firewall Options. The display will be refreshed on every five seconds.

By clicking the icon [+], the status table will be expanded to display log history. Clicking the **Edit** button the screen will be switched to the configuration page.

Packet Filter Status

Packet Filters Edit			
Activated Filter Rule	Detected Contents	IP	Time

Packet Filter Status		
Item	Value setting	Description
Activated Filter Rule	N/A	This is the Packet Filter Rule name.
Detected Contents	N/A	This is the logged packet information, including the source IP, destination IP, protocol, and destination port –the TCP or UDP. String format: Source IP to Destination IP : Destination Protocol (TCP or UDP)
IP	N/A	The Source IP (IPv4) of the logged packet.
Time	N/A	The Date and Time stamp of the logged packet. Date & time format. ("Month" "Day" "Hours":"Minutes":"Seconds")

Note: Ensure Packet Filter Log Alert is enabled.

*Refer to **Security > Firewall > Packet Filter** tab. Check Log Alert and save the setting.*

URL Blocking Status

URL Blocking Edit			
Activated Blocking Rule	Blocked URL	IP	Time

URL Blocking Status		
Item	Value setting	Description
Activated Blocking Rule	N/A	This is the URL Blocking Rule name.
Blocked URL	N/A	This is the logged packet information.
IP	N/A	The Source IP (IPv4) of the logged packet.

4G IIoT LoRa Gateway

Time	N/A	The Date and Time stamp of the logged packet. Date & time format. ("Month" "Day" "Hours":"Minutes":"Seconds")
-------------	-----	---

Note: Ensure URL Blocking Log Alert is enabled.

Refer to **Security > Firewall > URL Blocking** tab. Check Log Alert and save the setting.

Web Content Filter Status

Web Content Filters		Edit		
Activated Filter Rule		Detected Contents	IP	Time
Web Content Filter Status				
Item	Value setting	Description		
Activated Filter Rule	N/A	Logged packet of the rule name. String format.		
Detected Contents	N/A	Logged packet of the filter rule. String format.		
IP	N/A	Logged packet of the Source IP. IPv4 format.		
Time	N/A	Logged packet of the Date Time. Date time format ("Month" "Day" "Hours":"Minutes":"Seconds")		

Note: Ensure Web Content Filter Log Alert is enabled.

Refer to **Security > Firewall > Web Content Filter** tab. Check Log Alert and save the setting.

MAC Control Status

MAC Control		Edit		
Activated Control Rule		Blocked MAC Addresses	IP	Time
MAC Control Status				
Item	Value setting	Description		
Activated Control Rule	N/A	This is the MAC Control Rule name.		
Blocked MAC Addresses	N/A	This is the MAC address of the logged packet.		
IP	N/A	The Source IP (IPv4) of the logged packet.		
Time	N/A	The Date and Time stamp of the logged packet. Date & time format. ("Month" "Day" "Hours":"Minutes":"Seconds")		

Note: Ensure MAC Control Log Alert is enabled.

Refer to **Security > Firewall > MAC Control** tab. Check Log Alert and save the setting.

4G IIoT LoRa Gateway

Application Filters Status

Application Filters Edit			
Filtered Application Category	Filtered Application Name	IP	Time

Application Filters Status		
Item	Value setting	Description
Filtered Application Category	N/A	The name of the Application Category being blocked.
Filtered Application Name	N/A	The name of the Application being blocked.
IP	N/A	The Source IP (IPv4) of the logged packet.
Time	N/A	The Date and Time stamp of the logged packet. Date & time format. ("Month" "Day" "Hours":"Minutes":"Seconds")

Note: Ensure Application Filter Log Alert is enabled.

Refer to **Security > Firewall > Application Filter** tab. Check Log Alert and save the setting.

IPS Status

IPS Edit		
Detected Intrusion	IP	Time

IPS Firewall Status		
Item	Value setting	Description
Detected Intrusion	N/A	This is the intrusion type of the packets being blocked.
IP	N/A	The Source IP (IPv4) of the logged packet.
Time	N/A	The Date and Time stamp of the logged packet. Date & time format. ("Month" "Day" "Hours":"Minutes":"Seconds")

Note: Ensure IPS Log Alert is enabled.

Refer to **Security > Firewall > IPS** tab. Check Log Alert and save the setting.

4G IIoT LoRa Gateway

Firewall Options Status

Options Edit			
Stealth Mode	SPI	Discard Ping from WAN	Remote Administrator Management
Disable	Disable	Disable	IP: 192.168.121.54, User Name: admin, Time: Apr 1 11:14:54

Firewall Options Status		
Item	Value setting	Description
Stealth Mode	N/A	Enable or Disable setting status of Stealth Mode on Firewall Options. String Format: Disable or Enable
SPI	N/A	Enable or Disable setting status of SPI on Firewall Options. String Format : Disable or Enable
Discard Ping from WAN	N/A	Enable or Disable setting status of Discard Ping from WAN on Firewall Options. String Format: Disable or Enable
Remote Administrator Management	N/A	Enable or Disable setting status of Remote Administrator. If Remote Administrator is enabled, it shows the currently logged in administrator's source IP address and login user name and the login time. Format: IP : "Source IP", User Name: "Login User Name", Time: "Date time" Example: IP: 192.168.127.39, User Name: admin, Time: Mar 3 01:34:13

Note: Ensure Firewall Options Log Alert is enabled.

Refer to **Security > Firewall > Options** tab. Check Log Alert and save the setting.

4G IIoT LoRa Gateway

8.4 Administration

8.4.1 Configure & Manage Status

Go to **Status > Administration > Configure & Manage** tab.

The **Configure & Manage Status** window shows the status for managing remote network devices. The type of management available in your device is depended on the device model purchased. The commonly used ones are the SNMP, TR-069, and UPnP. The display will be refreshed on every five seconds.

SNMP Linking Status

SNMP Link Status screen shows the status of current active SNMP connections.

SNMP Linking Status						
User Name	IP Address	Port	Community	Auth. Mode	Privacy Mode	SNMP Version

SNMP Link Status	Item	Value setting	Description
	User Name	N/A	It displays the user name for authentication. This is only available for SNMP version 3.
	IP Address	N/A	It displays the IP address of SNMP manager.
	Port	N/A	It displays the port number used to maintain connection with the SNMP manager.
	Community	N/A	It displays the community for SNMP version 1 or version 2c only.
	Auth. Mode	N/A	It displays the authentication method for SNMP version 3 only.
	Privacy Mode	N/A	It displays the privacy mode for version 3 only.
	SNMP Version	N/A	It displays the SNMP Version employed.

SNMP Trap Information

SNMP Trap Information screen shows the status of current received SNMP traps.

SNMP Trap Information		
Trap Level	Time	Trap Event

SNMP Trap Information	Item	Value setting	Description
	Trap Level	N/A	It displays the trap level.
	Time	N/A	It displays the timestamp of trap event.
	Trap Event	N/A	It displays the IP address of the trap sender and event type.

4G IIoT LoRa Gateway

TR-069 Status

TR-069 Status screen shows the current connection status with the TR-068 server.

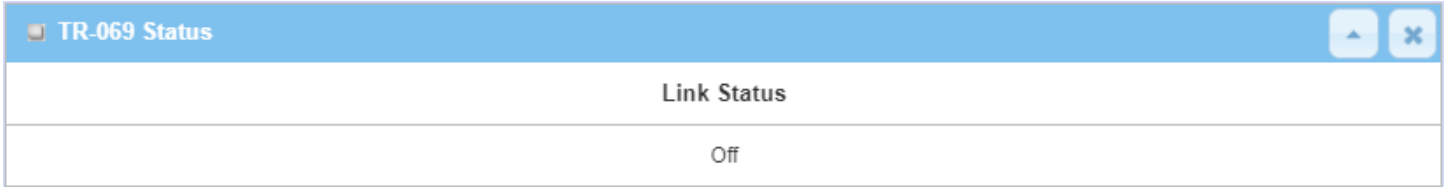

TR-069 Status		
Item	Value setting	Description
Link Status	N/A	It displays the current connection status with the TR-068 server. The connection status is either On when the device is connected with the TR-068 server or Off when disconnected.

4G IIoT LoRa Gateway

8.4.2 Log Storage Status

Go to **Status > Administration > Log Storage** tab.

The **Log Storage Status** screen shows the status for selected device storage.

Log Storage Status

Log Storage Status screen shows the status of current the selected device storage. The status includes Device Description, Usage, File System, Speed, and status.

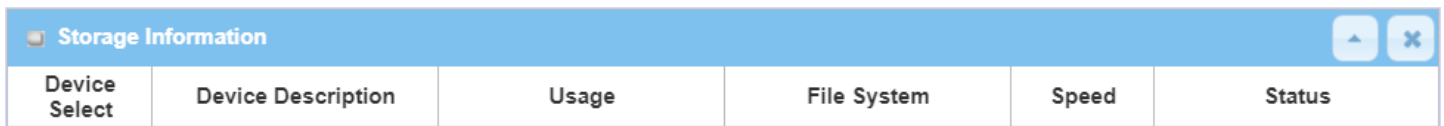

Storage Information					
Device Select	Device Description	Usage	File System	Speed	Status

4G IIoT LoRa Gateway

8.5 Statistics & Report

8.5.1 Connection Session

Go to **Status > Statistics & Reports > Connection Session** tab.

Internet Surfing Statistic shows the connection tracks on this router.

Internet Surfing List (14 entries) Previous Next First Last Export (.xml) Export (.csv)					
Refresh					
User Name	Protocol	Internal IP & Port	MAC	External IP & Port	Duration Time
	UDP	192.168.127.58:3847		88.198.95.100:1194	2019/04/01 12:09~
	UDP	192.168.127.58:4486		192.168.123.10:53	2019/04/01 12:09~
	UDP	192.168.127.58:2899		192.168.123.10:53	2019/04/01 12:09~
	UDP	192.168.127.58:1251		192.168.123.10:53	2019/04/01 12:09~
	UDP	192.168.127.58:3145		192.168.123.10:53	2019/04/01 12:09~

Internet Surfing Statistic		
Item	Value setting	Description
Previous	N/A	Click the Previous button; you will see the previous page of track list.
Next	N/A	Click the Next button; you will see the next page of track list.
First	N/A	Click the First button; you will see the first page of track list.
Last	N/A	Click the Last button; you will see the last page of track list.
Export (.xml)	N/A	Click the Export (.xml) button to export the list to xml file.
Export (.csv)	N/A	Click the Export (.csv) button to export the list to csv file.
Refresh	N/A	Click the Refresh button to refresh the list.

4G IIoT LoRa Gateway

8.5.2 Network Traffic

Go to **Status > Statistics & Reports > Network Traffic** tab.

Network Traffic Statistics screen shows the historical graph for the selected network interface.

You can change the interface drop list and select the interface and sampling time interval you want to monitor.

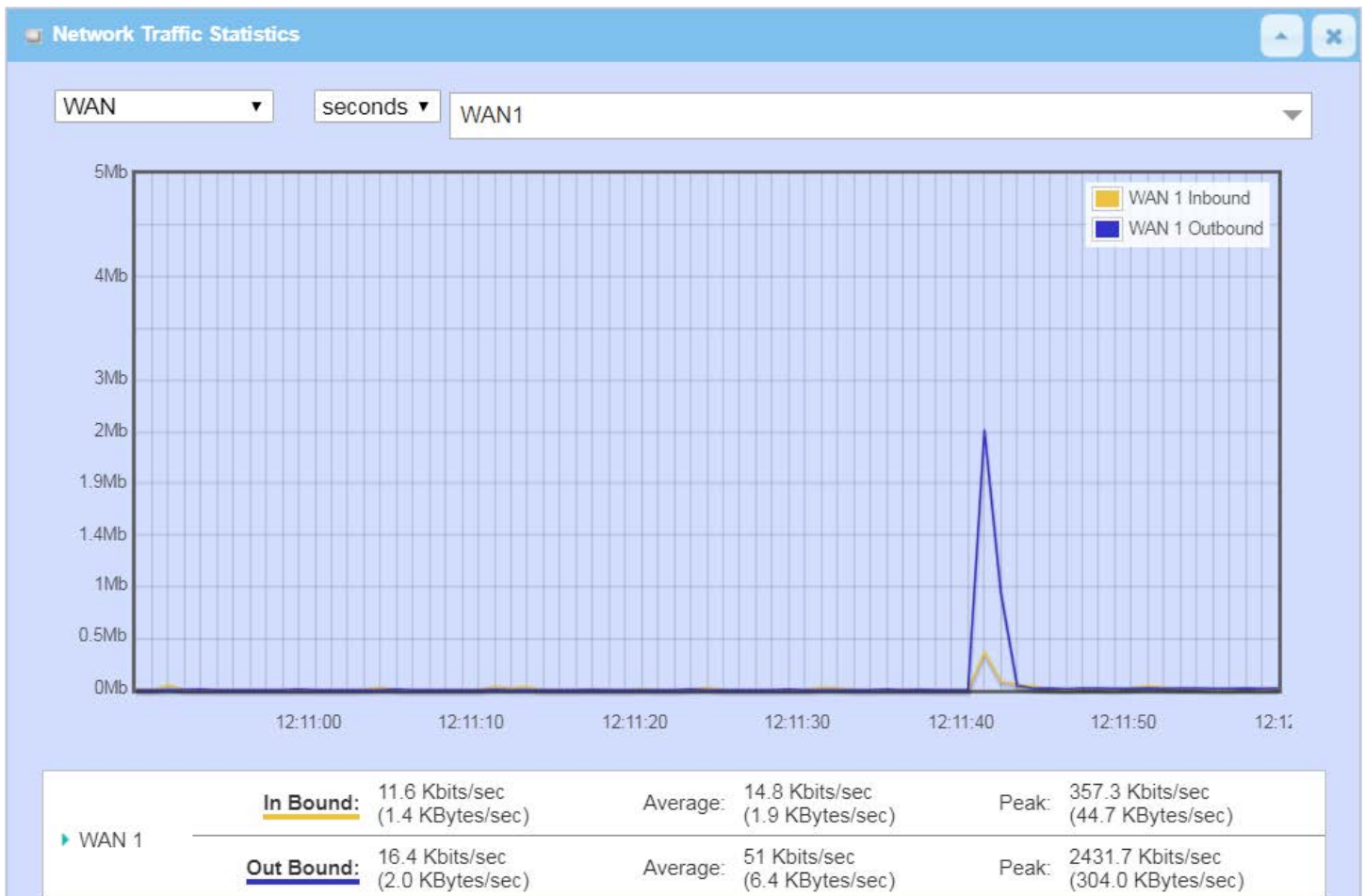

4G IIoT LoRa Gateway

8.5.3 Login Statistics

Go to **Status > Statistics & Reports > Login Statistics**

Login Statistics shows the login information.

Device Manager Login Statistics				
Refresh				
User Name	Protocol Type	IP Address	User Level	Duration Time
admin	http/https	192.168.121.54	Admin	2019/04/01 11:14~

Device Manager Login Statistic		
Item	Value setting	Description
Previous	N/A	Click the Previous button; you will see the previous page of login statistics.
Next	N/A	Click the Next button; you will see the next page of login statistics.
First	N/A	Click the First button; you will see the first page of login statistics.
Last	N/A	Click the Last button; you will see the last page of login statistics.
Export (.xml)	N/A	Click the Export (.xml) button to export the login statistics to xml file.
Export (.csv)	N/A	Click the Export (.csv) button to export the login statistics to csv file.
Refresh	N/A	Click the Refresh button to refresh the login statistics.

4G IIoT LoRa Gateway

8.5.4 Cellular Usage

Go to **Status > Statistics & Reports > Cellular Usage** tab.

Cellular Usage screen shows data usage statistics for the selected cellular interface. The cellular data usage can be accumulated per hour or per day.



Appendix A GPL WRITTEN OFFER

This product incorporates open source software components covered by the terms of third party copyright notices and license agreements contained below.

GPSBabel
Version 1.4.4
Copyright (C) 2002-2005 Robert Lipe<robertlipe@usa.net>
GPL License: <https://www.gpsbabel.org/>

Curl
Version 7.19.6
Copyright (c) 1996-2009, Daniel Stenberg, <daniel@haxx.se>.
MIT/X derivate License: <https://curl.haxx.se/>

OpenSSL
Version 1.0.2m
Copyright (C) 1995-1998 Eric Young (eay@cryptsoft.com)
GPL License: <https://www.openssl.org/>

brctl - ethernet bridge administration
Stephen Hemminger <shemminger@osdl.org>
Lennert Buytenhek <buytenh@gnu.org>
version 1.1
GNU GENERAL PUBLIC LICENSE Version 2, June 1991

tc - show / manipulate traffic control settings
Stephen Hemminger<shemminger@osdl.org>
Alexey Kuznetsov<kuznet@ms2.inr.ac.ru>
version iproute2-ss050330
GNU GENERAL PUBLIC LICENSE Version 2, June 1991

dhcp-fwd — starts the DHCP forwarding agent
Enrico Scholz <enrico.scholz@informatik.tu-chemnitz.de>
version 0.7
GNU GENERAL PUBLIC LICENSE Version 2, June 1991

lftp - Sophisticated file transfer program
Alexander V. Lukyanov <lav@yars.free.net>
version:4.5.x
Copyright (c) 1996-2014 by Alexander V. Lukyanov (lav@yars.free.net)

dnsmasq - A lightweight DHCP and caching DNS server.

4G IIoT LoRa Gateway

Simon Kelley <simon@thekelleys.org.uk>

version:2.72

dnsmasq is Copyright (c) 2000-2014 Simon Kelley

socat - Multipurpose relay

Version: 2.0.0-b8

GPLv2

<http://www.dest-unreach.org/socat/>

LibModbus

Version: 3.0.3

LGPL v2

<http://libmodbus.org/news/>

LibIEC60870

GPLv2

Copyright (C) 1989, 1991 Free Software Foundation, Inc. 59 Temple Place, Suite 330, Boston, MA 02111-1307 USA

<https://sourceforge.net/projects/mrts/>

Openswan

Version: v2.6.38 GNU GENERAL PUBLIC LICENSE Version 2, June 1991

Copyright (C) 1989, 1991 Free Software Foundation, Inc. 59 Temple Place, Suite 330, Boston, MA 02111-1307 USA

Everyone is permitted to copy and distribute verbatim copies of this license document, but changing it is not allowed.

<https://www.openswan.org/>

Opennhp

Version: v0.14.1

OpenNHRP is an NHRP implementation for Linux. It has most of the RFC2332 and Cisco IOS extensions.

Project homepage: <http://sourceforge.net/projects/opennhp>

Git repository: <git://opennhp.git.sourceforge.net/gitroot/opennhp>

LICENSE

OpenNHRP is licensed under the MIT License. See MIT-LICENSE.txt for additional details.

OpenNHRP embeds libev. libev is dual licensed with 2-clause BSD and GPLv2+ licenses. See libev/LICENSE for additional details.

OpenNHRP links to c-ares. c-ares is licensed under the MIT License.

<https://sourceforge.net/projects/opennhp/>

IPSec-tools

Version: v0.8

4G IIoT LoRa Gateway

No GPL be written

<http://ipsec-tools.sourceforge.net/>

PPTP

Version: pptp-1.7.1

GNU GENERAL PUBLIC LICENSE Version 2, June 1991

Copyright (C) 1989, 1991 Free Software Foundation, Inc. 675 Mass Ave, Cambridge, MA 02139, USA

Everyone is permitted to copy and distribute verbatim copies of this license document, but changing it is not allowed.

<http://pptpclient.sourceforge.net/>

PPTPServ

Version: 1.3.4

GNU GENERAL PUBLIC LICENSE Version 2, June 1991

Copyright (C) 1989, 1991 Free Software Foundation, Inc. 675 Mass Ave, Cambridge, MA 02139, USA

Everyone is permitted to copy and distribute verbatim copies

of this license document, but changing it is not allowed. <http://poptop.sourceforge.net/>

L2TP

Version: 0.4

Copying All software included in this package is Copyright 2002 Roaring Penguin Software Inc. You may distribute it under the terms of the GNU General Public License (the "GPL"), Version 2, or (at your option) any later version.

<http://www.roaringpenguin.com/>

L2TPServ

Version: v 1.3.1 GNU GENERAL PUBLIC LICENSE Version 2, June 1991

Copyright (C) 1989, 1991 Free Software Foundation, Inc. 59 Temple Place, Suite 330, Boston, MA 02111-1307 USA

Everyone is permitted to copy and distribute verbatim copies of this license document, but changing it is not allowed.

<http://www.xelerance.com/software/xl2tpd/>

Mpstat: from sysstat, system performance tools for Linux

Version: 10.1.6

Copyright: (C) 1999-2013 by Sebastien Godard (sysstat <at> orange.fr)

SSHD: dropbear, a SSH2 server

Version: 0.53.1

Copyright: (c) 2002-2008 Matt Johnston

Libncurses: The ncurses (new curses) library is a free software emulation of curses in System V Release 4.0 (SVr4), and more.

4G IIoT LoRa Gateway

Version: 5.9

Copyright: (c) 1998,2000,2004,2005,2006,2008,2011,2015 Free Software Foundation, Inc., 51 Franklin Street, Boston, MA 02110-1301, USA

MiniUPnP: The miniUPnP daemon is an UPnP IGD (internet gateway device) which provide NAT traversal services to any UPnP enabled client on the network.

Version: 1.7

Copyright: (c) 2006-2011, Thomas BERNARD

CoovaChilli is an open-source software access controller for captive portal (UAM) and 802.1X access provisioning.

Version: 1.3.0

Copyright: (C) 2007-2012 David Bird (Coova Technologies) <support@coova.com>

Krb5: Kerberos is a network authentication protocol. It is designed to provide strong authentication for client/server applications by using secret-key cryptography.

Version: 1.11.3

Copyright: (C) 1985-2013 by the Massachusetts Institute of Technology and its contributors

OpenLDAP: a suite of the Lightweight Directory Access Protocol (v3) servers, clients, utilities, and development tools.

Version: 2.4

Copyright: 1998-2014 The OpenLDAP Foundation

Samba3311: the free SMB and CIFS client and server for UNIX and other operating systems

Version: 3.3.11

Copyright: (C) 2007 Free Software Foundation, Inc. <<http://fsf.org/>>

NTPClient: an NTP (RFC-1305, RFC-4330) client for unix-alike computers

Version: 2007_365

Copyright: 1997, 1999, 2000, 2003, 2006, 2007 Larry Doolittle

exFAT: FUSE-based exFAT implementation

Version: 0.9.8

Copyright: (C) 2010-2012 Andrew Nayenko

ONTF5_3G: The NTFS-3G driver is an open source, freely available read/write NTFS driver for Linux, FreeBSD, Mac OS X, NetBSD, Solaris and Haiku.

Version: 2009.4.4

Copyright: (C) 1989, 1991 Free Software Foundation, Inc., 51 Franklin Street, Fifth Floor, Boston, MA 02110-1301 USA

mysql-5_1_72: a release of MySQL, a dual-license SQL database server

Version: 5.1.72

4G IIoT LoRa Gateway

Copyright: (c) 2000, 2013, Oracle and/or its affiliates

FreeRadius: a high performance and highly configurable RADIUS server

Version: 2.1.12

Copyright: (C) 1999-2011 The FreeRADIUS server project and contributors

Linux IPv6 Router Advertisement Daemon – radvd

Version: V 1.15

Copyright (c) 1996,1997 by Lars Fenneberg<lf@elemental.net>

BSD License: <http://www.litech.org/radvd/>

WIDE-DHCPv6

Dynamic Host Configuration Protocol for IPv6 (DHCPv6) clients, servers, and relay agents.

Version: 20080615

Copyright (C) 1998-2004 WIDE Project.

BSD License: <https://sourceforge.net/projects/wide-dhcpv6/>

Python version 2.7.12

This Python distribution contains no GNU General Public Licensed (GPLed) code so it may be used in proprietary projects just like prior Python distributions. There are interfaces to some GNU code but these are entirely optional

OpenPAM Radula

This software was developed for the FreeBSD Project by ThinkSec AS and Network Associates Laboratories, the Security Research Division of Network Associates, Inc. under DARPA/SPAWAR contract N66001-01-C-8035 ("CBOSS"), as part of the DARPA CHATS research program.

ISC DHCP Version 4.3.5

Copyright (c) 2004-2016 by Internet Systems Consortium, Inc. ("ISC")